

Multi-Spectral Laser Scanning for Inspection of Building Surfaces

— state of the art and future concepts —

A. Wehr¹, M. Hemmleb² and Chr. Maierhofer²

¹Institut for Navigation, University Stuttgart, Germany

²Federal Institute for Materials Research and Testing (BAM), Berlin, Germany

Abstract

The Federal Institute for Materials Research and Testing (BAM) developed a multi-spectral laser scanner to demonstrate the advantages of such systems for the inspection of building surfaces. It is shown that damage of building surfaces, caused by enhanced moisture content and/or vegetation, can be recorded automatically with a high signal-to-noise ratio by using four continuous wave semiconductor lasers at different wavelengths for the defined illumination of the object surface. It is worked out that the damaged areas can be identified by applying commercial multi-spectral image processing software. Finally a concept is presented to improve the overall performance of the system with regard to sampling speed and sensitivity. Here the cw lasers are modulated by sinusoidal signals of different frequencies and the intensity of the backscattered laser light is detected by synchronous demodulation. Furthermore, these structured signals can be used for slant range measurements. Knowing the slant for each pixel, three dimensional multi-spectral images are obtained.

Categories and Subject Descriptors (according to ACM CCS): I.4.1 [Digitization and Image Capture]: Scanning

1. Introduction

Precedent examination of building structures plays a crucial role for the planning of construction and restoration tasks. The multitude of possible damage of building surfaces makes manual damage mapping extensive and time-consuming. Therefore it is desirable to apply a method, based on image recording and processing for damage assessment, which also covers inaccessible parts of the building surface. It should also provide data for further analysis and classification of the existing damage. This approach offers good preconditions for automated damage detection. The surface structure and condition and especially its time-dependent changes have to be detected. Important damage of building surfaces are weathering, corrosion, salt blooming and biological changes like moss, lichen, moulds and moisture. The quantitative measurement of the moisture content has a particular importance, as most of the other damage is correlated with it.

Multi-spectral image recording techniques offer the possibility to detect damages on building surfaces. Image regions

can be assigned to affected (e.g. damaged by moisture or vegetation) surface regions. The dimension of the damaged area can be measured quantitatively. Therefore, according to [BR82], [SSG90], [Fri03], [GAG95], [Ler01], [LRB00] and [Wig02] the results of a multi-spectral analysis especially in the near infrared (NIR) can serve as a basis for damage mapping, delivering quantitative results on the damaged area and about the nature of the damage.

Today multi-spectral imaging systems e.g. RGB cameras, infrared cameras and opto-electronical scanning devices all have in common that they are passive sensors which need external illumination. If sunlight is used, an illumination source with a large spectral bandwidth is available. As sunlight is changing with daytime season expensive calibration is required. In case of artificial illumination sources e.g. flash light or lamps one has to regard that all required spectral bands are existent. To circumvent the disadvantages of passive sensors BAM decided to develop an active multi-spectral sensor. As lasers offer well defined monochromatic optical radiation with the required intensity for remote sens-

ing tasks and as they are small and robust, an imaging laser scanner using four semiconductor laser diodes working at different wavelengths was realized. The experiments carried out with this new device demonstrated that the recorded data could be processed with different commercial software tools enabling multi-spectral classification. It will be shown that information about the surface conditions and surface damages are gained from the difference in spectral reflectivity. As the spectral radiation powers of the lasers are known, even quantitative measurements of the damages are possible.

The sensitivity of BAM's multi-spectral laser scanning system can be improved, if the intensity of laser light is modulated with a known signal, e.g. a sinusoidal one, and detected by a correlation receiver. Applying this receiving technique the detected signal is not disturbed by background radiation e.g. extensive sunlight. Furthermore the modulation can be exploited for ranging. Besides actual temperature and humidity the slant range information is most important for quantitative measurements, because the intensity value for each pixel must be corrected by the free space loss which is a function of the instantaneous range.

2. Information Possibilities of Multi-Spectral Data

According to [Kra96] imaging spectrometers are applied to detect, measure and analyse the spectral content of the incident electromagnetic field besides the geometrical image content. The spectral information is required either to determine the chemical composition, the type and the physical condition of an object. After the acquisition imaging spectrometers deliver k images where k is the number of spectral bands available. In case of laser scanners number k is determined by the number of different lasers included in the system. The spatial resolution is determined by the number of pixels within the field of view (FOV). The pixel size is given by the instantaneous field of view (IFOV). Figure 1 makes clear that after acquisition images with k layers are available in accordance to the k spectral bands. Figure 1 depicts that each pixel of one image layer contains the intensity of the received electromagnetic signal in the narrow spectral band of the corresponding sensor and laser respectively. Evaluating the intensities of all layers for a certain pixel, results in a characteristic spectrum for this pixel (s. Figure 1). This intensity spectrum represents the reflectance spectrum.

Each material and each sort of vegetation has a characteristic spectral reflectance (s. Figure 2) which can be used for computer aided classification. The classification is carried out in the feature space (s. Figure 3).

The studies carried out at BAM [HWSM06] make clear that commercial image processing software for remote sensing data can be applied on the gathered data sets. Best results were obtained by programs working with object based classification.

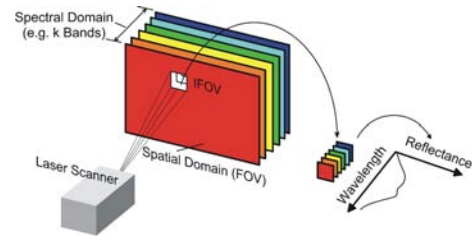

Figure 1: Imaging spectrometer

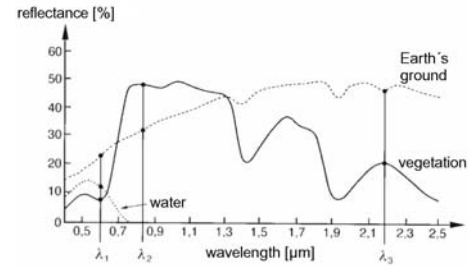

Figure 2: Typical spectral reflectance of different materials (acc. [Alb01])

In the following it will be worked out that vegetation indices can be computed from the laser scanner surveys by combining the different spectral layers also called image channels. The Normalized Difference Vegetation Index (NDVI) is calculated by

$$ndvi = \frac{x_{IR} - x_R}{x_{IR} + x_R} \quad (1)$$

with x_{IR} : intensity measurement value at $\lambda_{IR} = 808 \text{ nm}$
 x_R : intensity measurement value at $\lambda_R = 670 \text{ nm}$

It relates the intensity values measured in near infrared (x_{IR}) to intensity values obtained in red spectrum (x_R). For example infrared radiation is highly backscattered from the surface of healthy vegetation because chlorophyll exhibit a minimum of absorption in this spectral band. Whereas, the

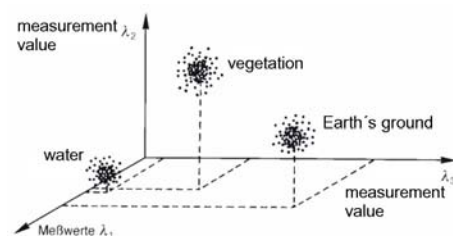

Figure 3: Feature based space for multi-spectral classification (acc. [Alb01])

red color laser beam shows low reflectance, because it is well absorbed. Exploiting these effects and determining NDVI vegetation on building surfaces can be detected easily and its distribution and by that the possible damage of a building can be classified.

According to NDVI the Normalized Difference Moisture Index (NDMI) was derived:

$$ndmi = \frac{x_{ref} - x_{IR}}{x_{ref} + x_{IR}} \quad (2)$$

with x_{ref} = intensity measurement value at reference wavelength, here at $\lambda_{ref} = 980$ nm

x_{IR} = intensity measurement value at $\lambda_{IR} = 1930$ nm

At this the measured intensity values spectrally located within the absorption line of water (here 1930 nm) are related to the intensity values obtained at reference wavelength (here 980 nm) which is insensitive against water contents. This means, NDMI represents a measure concerning the moisture content of the surface for the object under test.

The computation of NDVI and NDMI is integrated in the control and measurement software of the laser scanner described in the following chapter. After the measurement the user has available both indices as separate images, which permit an instant overview about the distribution of wet and vegetation at the building surface.

3. State of the Art of Multi-Spectral Laser Scanner Development

BAM built-up a breadboard multi-spectral laser scanner in the laboratory to analyse and to demonstrate the possibilities and limitation of such devices. The carried out experiments also offered design parameters for future multi-spectral laser scanners.

3.1. Multi-Spectral Laser Scanner

The laser scanner developed at BAM consists of four fibre-coupled semi-conductor laser diodes with different wavelengths, selected for the detection of moisture, natural cover and mineral changes. Considering the requirements for damage detection and the availability of laser diodes, the following wavelengths were chosen: 670 nm, 808 nm, 980 nm and 1930 nm. Suitable detectors based on Si and InGaAs photodiodes in combination with optical filters are used for the measurement of the reflected radiation.

For the realisation of a scanning measurement system, two different devices were selected and tested under laboratory conditions: a pan-tilt-unit as carrier for the multi-spectral-head (as shown in Figure 4 and Figure 5) and a mirror-scanning device, as known from 3D laser scanners. Geometric and radiometric calibration experiments were carried out.

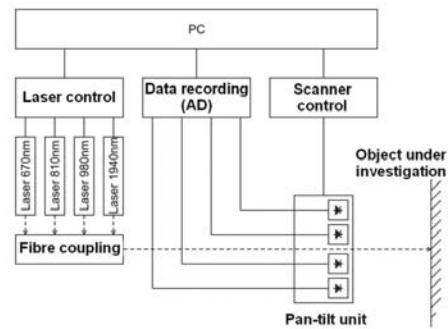

Figure 4: Set-up of the multi-spectral laser scanner with pan-tilt unit

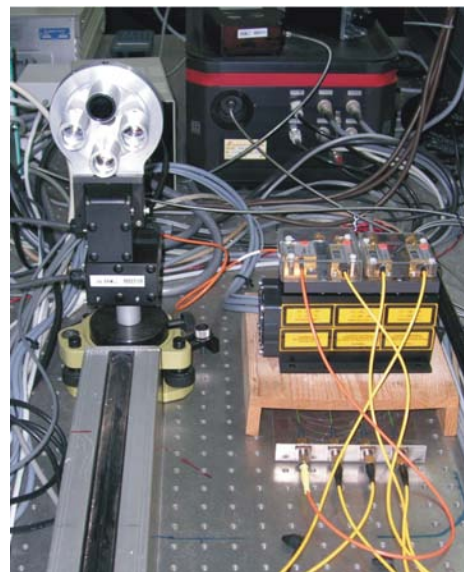

Figure 5: Left: Pan-tilt unit with measurement head, right: laser diodes and fibre coupling unit

Measurement control and data recording is run on a notebook. The results are saved in a data file containing the intensity of the detected reflections for the different wavelengths for each pixel as well as the 2D geometric position. For data analysis, the reflection intensity of each channel, the NDVI and the NDMI are plotted automatically as a function of geometric position. Additionally, the data can be saved in an output file, which can be directly used for enhanced multi-spectral classification with commercial software. The technical data are compiled in Table 1.

The first prototype of the multi-spectral laser scanner was set-up for laboratory investigation, and can principally be applied on-site, too. Further improvement is required for the robustness of the system, for the optimisation of the distance between measurement system and surface under investiga-

Table 1: Key components of laser scanner

laser	ALS multi-spectral laser system with semiconductor laser diodes with 670 nm, 808 nm, 980 nm, 1930 nm mounted on cooling radiator KB40
laser control	ALS (special design on basis of DioPower DP5)
optics	SuK fiber collimators (special design)
	Receiving optic for PTU (inhouse development)
	FhG IZM fiber couplers in different designs (special design)
detector	J1 577 Si photodiode with filter 670 nm, 810 nm, 980 nm
	J18 InGaAs photodiode with filter 1940 nm
data logger	NI DAQPad-6015 (USB)
scanner	DP PTU C46-17.5W with control PT-CB46C14
	Polytec mirror scanner OFV 040 with control DX 2102
controler	Sony Notebook 3GHz with software LabVIEW 7.1
visualisation and processing	LaserImage (inhouse development) Erdas Imagine 8.7

tion and for the measurement time per pixel, which can be drastically reduced by using the modulated laser light, e.g. pulsed or sinusoidal modulation.

3.2. Measurement Results and Data Processing

Before BAM's multi-spectral laser scanner could be used for measurement tasks, test and calibration measurements had to be carried out. First, the radiometrical and geometrical reproducibility and stability of the whole system was tested and approved. This included the determination of the limits and the required parameters for later application. These measurement data were obtained by measurements of reflection properties of several different building materials (especially historic bricks and stones). During the tests material parameters such as moisture content and roughness of surfaces had been varied (see Figure 6 and Figure 7). For optimising the measurement parameters, the required power of the laser diodes and the distances of the scanner unit with respect to the measured surface were investigated systematically.

A small test specimen (wall consisting of several small cut bricks [cubes with a size of $5 \times 5 \times 5 \text{ cm}^3$]) was studied as shown in Figure 8. First, all bricks were measured in dry condition. Afterwards, two bricks were stored in water and the measurements were repeated for the determination of the

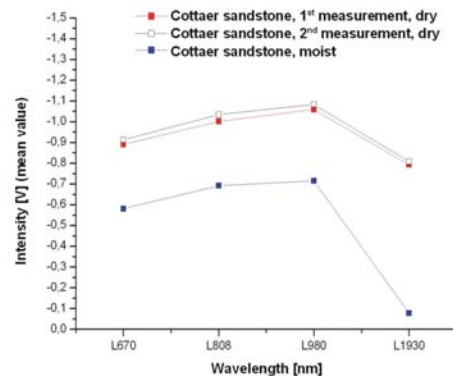

Figure 6: Intensity of reflection for dry and moist sand stone at different wavelengths. The wavelength axis is not scaled

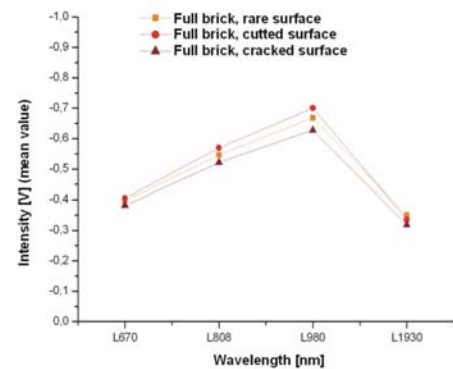

Figure 7: Intensity of reflection at different surfaces (roughness). The wavelength axis is not scaled

moisture distribution at the surface. In addition to the four image channels for the four different wavelengths, also the NDMI was calculated from the reference wavelength (980 nm) and from the wavelength related to water absorption (1930 nm) as described above.

The distribution of the NDMI is displayed in Figure 9 as a false colour image. The area with enhanced moisture is clearly shown. At the bottom of the two moist bricks, water penetrated the joining dry bricks. Additionally, the differences in contrast due to varying surface properties recognised in Figure 8 outside the moist areas are not shown any more in Figure 9. The remaining small differences at the position of the edges of the bricks in Figure 9 and the increased NDMI at the bottom of the image are related to direct reflections of the laser radiation at the edges and to double reflections at the bearing surface of the test specimen, respectively.

The NDMI given in Figure 9 is only a measure for the relative moisture distribution at the surface of the specimen. For the determination of the absolute moisture content, a cal-

ibration of the measurement system with a reference measurement method is required.



Figure 8: Wall consisting of small brick, two of the bricks are moist. The photo was taken with a digital camera

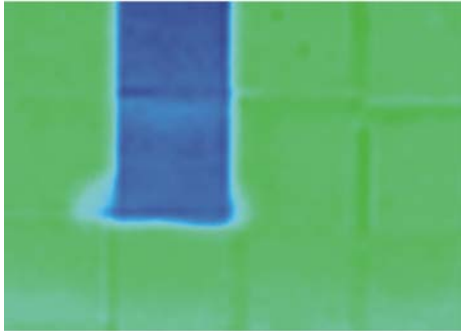

Figure 9: Distribution of the NDMI calculated from the multi-spectral scan and being a measure for the relative moisture distribution

4. Future Concepts for Multi-Spectral Laser Scanning

BAM's laser scanner transmits unmodulated signals. Therefore the backscattered laser signal from the object surface cannot be separated from background light. If the intensity of the laser radiation is modulated by e.g. sinusoidal signals the received backscattered laser light can be detected without disturbing background light. Those systems require correlation receivers which are also known as lock-in receivers. Using such technique improves the sensitivity and by that the range and possible measurement rate respectively. However, intensity modulation of laser light is a well established technique for 3D laser scanners using continuous wave semiconductor lasers [HW97], [FM04], [BV04]. [HW97], [FM04], [BV04] showed that high scanning rates with slant range accuracy down to sub-millimeter are possible. Therefore by integrating modulation techniques the multi-spectral laser scanner offers the possibility to obtain 3D multispectral measurement data. 3D information is most

important for the succeeding automatic measurement evaluation. The 3D data can be used to model the surveyed object surface. Knowing the surface topography the actual incident angle for each measurement point can be calculated. This improves the accuracy of the reflectance measurement. The exact knowledge of how the optical signal is damped by the atmosphere is inalienable for measuring moisture parameters on building surfaces by infra red light. To regard precisely this effect the actual travelling length of the transmit and received laser radiation must be known. Then the free-space-loss and the influence of the atmosphere can be modeled.

In the following chapters the performance of 3D-cw-laser scanners will be outlined with regard to geometrical and intensity measurements. A demonstration experiment will depict that multispectral 3D-laser scanners can be realized with today's technology and will offer additional information, which can be processed by commercial remote sensing and classification software.

4.1. Intensity Modulation and Ranging

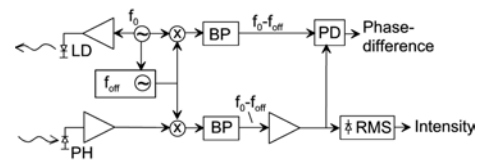

Figure 10: Principle blockchart for synchronous demodulation

Figure 10 depicts the blockchart for a typical transceiver with one signal using synchronous demodulation technique. The laser signal is intensity modulated with frequency f_0 . The optical photodetector PH demodulates the frequency f_0 . f_0 is down converted to the intermediate frequency $f_0 - f_{off}$. Only this special frequency is able to pass the bandpass filter. Therefore, only this signal can be detected and the intensity can be measured. This process is also known as heterodyning. If the receiving branch is also down converted to $f_0 - f_{off}$ the phase difference between transmit and received signal can be measured. From the phase difference ϕ at intermediate frequency $f_0 - f_{off}$ the slant range r can be computed by

$$r = \frac{1}{4\pi} \frac{c}{f_0} \phi \quad (3)$$

if c is the speed of light and f_0 the frequency of the intensity modulation of the laser.

For a multispectral system with n lasers the system must be extended to n transceiver units. At the first glance such systems seem to be very expensive. However Figure 11 and Figure 12 demonstrate the gain in sensitivity and possible range performance. Both images were sampled with

the same laser scanner in Museum for Natural Science Humboldt University Berlin. In Figure 11 the modulated laserlight was detected by synchronous demodulation. An average laser power of 5 mW was transmitted. The lower image shows the result with energy detection as applied by the BAM's multi-spectral laser scanner. In this case only the roof windows can be recognized, because they are illuminated by sunlight.

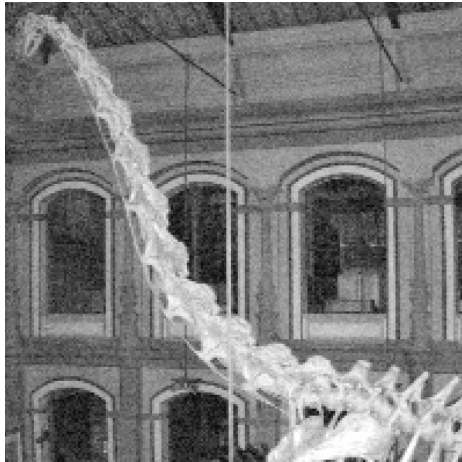

Figure 11: Detection of the modulated laser signal

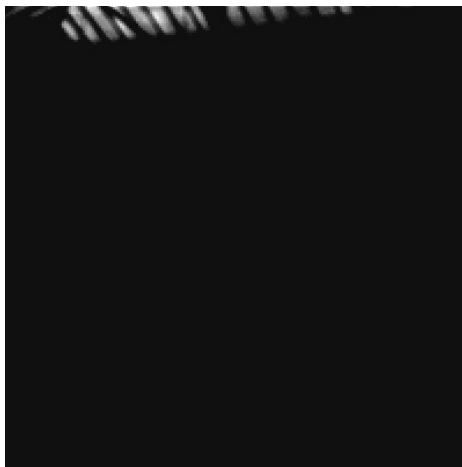

Figure 12: Energy detection of the unmodulated laser signal

This experiment makes clear that the sensitivity can be improved by several orders of magnitude. Using modulated laser light also ranging can be carried out by measuring the phase difference between the transmitted and received signal. This measurement principle is realized in the 3D-Laser Scanner (3D-LS) of the INS [HW97]. The technical data are compiled in Table 2.

Table 2: Technical parameters of 3D-LS

laser power	0.5 mW
optical wavelength	670 nm / 830 nm
inst. field of view IFOV	0.1°
total field of view FOV	30° x 30°
scanning pattern	2-dimensional line (standard) vertical line scan free programmable pattern
number of pixels per image	max. 32768 x 32768 pixels
range	<10 m, unambiguous range 15 m
ranging accuracy	0.1 mm (for diffuse reflecting targets with $\rho=60\%$ in 1m distance)
side tone frequencies	10 MHz, 314 MHz
measurement rate	2 kHz (using on side tone) 600 Hz (using two side tones)



Laser Intensity Image



Photo

Figure 13: Obelix: Measurement setup (photograph, lower image) and laser intensity image (upper image)

Besides others the system was applied to survey the reference brickwork at BAM called "Obelix". It is a large masonry specimen built-up by using traditional historic construction methods and materials, e.g. several regionally typical materials like bricks (manufactured at the brick kiln in Glinow), sandstone, granite, limestone and bog iron stone. The intensity image demonstrates the photo quality (s. Fig-

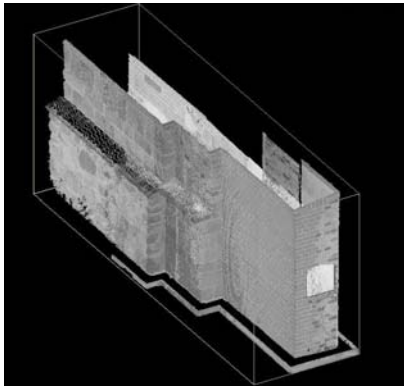

Figure 14: 3D-Animation view of Obelix 3D-LS data

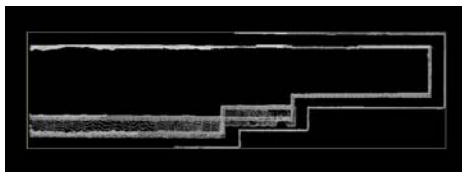

Figure 15: Top-view of Obelix

ure 13) of the system and the three dimensional performance can be learned from Figure 14 and Figure 15. This surveying demonstrates that the combination of 3D-information and intensity is most important, because the discrimination between the different materials cannot be carried out by the 3D-survey. Additional intensity information is required for a robust classification.

4.2. Possibilities of Multispectral 3D-LS

To study the possibilities of multi-spectral 3D laser scanners (3D-LSms) a laboratory scene with a banana plant was scanned with 3D-LS using semiconductor lasers at 670 nm and 830 nm. Figure 16 shows the surveying result. The plant exhibits high stress areas which can be well identified and classified (s. Figure 16). Figure 17 depicts the laser scanner survey result in ortho projection. The upper image is the composite of the spectral lines 670 nm and 830 nm. The decomposition of the two colours is shown in the lower images. The healthy parts of the plants appear very dark at 670 nm (red). This means the reflectance is very low. The stress areas can be recognized very well, because they exhibit a higher reflectance. In the NIR the total plant shows a higher reflectance. The contrast between stress and healthy areas is not as significant as at 670 nm. However the leaves are digitized comprehensively. This experiment demonstrates impressively the advantages of multispectral laser scanning. It makes clear that already with these two spectral laser lines a robust classification is possible and even a vegetation index can be calculated. Also three dimensional digitization

is improved with regard to robustness, because if a certain spectral laser line is poorly scattered back from a target the others will compensate this effect.

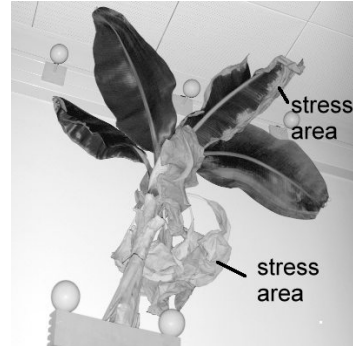

Figure 16: Banana plant laser intensity image at 670 nm

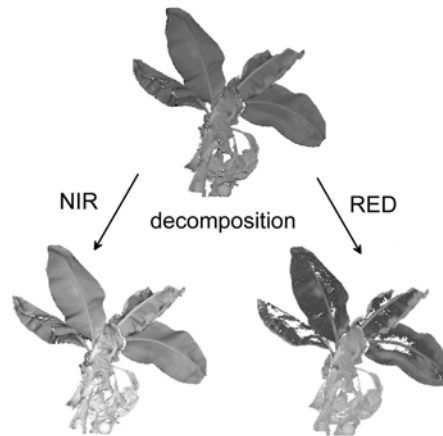

Figure 17: Multispectral laser data (ortho projection)

5. Conclusions

The evaluation experiments with BAM's multispectral laser scanner and the 3D-LS approve that imaging multi-spectral 3D laser scanning is a promising technology and certain classification tasks can be carried out with commercially available software. It was worked out very impressively that the sensitivity could be improved by orders of magnitude if a modulated laser signal is applied. A high sensitivity is required to reduce the transmitted laser power down to eyesafe levels and to cover ranges required for surveying of buildings.

In the application field of cultural heritage often questions are raised concerning the condition of historical masonry which is stressed by moisture and polluted by biological covering. Applying 3D-LSms, these loads on buildings can be

detected by multispectral analysis, and the 3D-information is used for three dimensional modelling of the studied surface which allows a robust and quantifiable classification. For example regarding moisture measurements the total length of the laser link from measurement device to object surface and back and the impact direction with regard to surface normal must be known to obtain valid or even calibrated moisture measurements.

Looking at cultural heritage already a lot of surveying data are gathered in the interior of ancient housings, castles and caves. Here the optimum illumination is the major problem. As 3D-LSms is an active sensor, this problem will not exist anymore. Therefore, it is planned to develop a 3D-LSms for operational use on basis of the presented technology.

Acknowledgements

The research project "Application of a multi-spectral laser scanner for the investigation of building surfaces" was funded by the Federal Office for Building and Regional Planning (BBR) (No. Z 6 - 10.07.03 / II 13 - 80010310). The authors would like to thank Dr. Friederike Weritz and Dieter Schaurich (BAM division VIII.2) for their support to this project, Anne Grote for programming control software, Gudrun Brinke for carrying out laboratory measurements, and Dipl.-Ing.(FH) Martin Thomas (INS) for carrying out laser scanner measurements and laser scanner data visualization.

References

- [Alb01] ALBERTZ J.: *Einführung in die Fernerkundung*, 2 ed. Wissenschaftliche Buchgesellschaft Darmstadt, 2001.
- [BR82] BÖTTCHER B., RICHTER H.: Ein Beitrag zum Nachweis von Feuchtigkeit in Mauerwerk mit Hilfe einer Infrarotkamera. *Materialprüfung* 24, 1 (1982), 5–9.
- [BV04] BECKER R., VOLZ H.: IQSUN 880 a new modular concept for 3d-laser scanning. In *Laser-Scanners for Forest and Landscape Assessment* (Lemmer, Netherlands, 2004), Thies M., Koch B., Spiecker H., Weinacker H., (Eds.), vol. XXXVI, Part 8/W2, GITC, pp. 7–13. Proceedings of the ISPRS working group VIII/2 in Freiburg, Germany.
- [FM04] FRÖHLICH C., METTENLEITER M.: Terrestrial laser scanning - new perspectives in 3d surveying. In *Laser-Scanners for Forest and Landscape Assessment* (Lemmer, Netherlands, 2004), Thies M., Koch B., Spiecker H., Weinacker H., (Eds.), vol. XXXVI, Part 8/W2, GITC, pp. 7–13. Proceedings of the ISPRS working group VIII/2 in Freiburg, Germany.
- [Fri03] FRIEDMANN M.: Zerstörungsfreie flächenmässig erfassbare Ortung von Hohlstellen und Feuchtigkeitsbelastungen mittels Infrarot-Thermografie. *Schriftenreihe des Feuchte- und Altbausanierung e.V.*, 14 (2003), 61–70. 14. Hanseatische Sanierungstage.
- [GAG95] GEYER E., ARNDT D., GÜNTHER B.: Bestimmung der Reflexion von trockenen und befeuchteten Baustoffen im Wellenlängenbereich 0,3 bis 2,5 μm für die Ir-optische Bestimmung der Feuchte. In *Feuchtag 1995, BAM Berlin* (1995), pp. 176–184.
- [GSG92] GODDING R., SACHER, G. SIEDLER G.: Einsatz von digitalen Aufnahmesystemen zur Gewinnung von Multispektralaufnahmen für die Erkundung von Bauwerksschäden. In *International Archives of Photogrammetry and Remote Sensing, Com. V* (New York, 1992), pp. 794–798.
- [HW97] HUG C., WEHR A.: Applications of imaging laser sensors in close-range metrology and remote sensing. In *Optical 3-D Measurement Techniques IV* (Amsterdam, 1997), Wichmann, pp. 141–148. Conference in Zurich 29. Sep. - 2. Oct. 1997.
- [HWS*06] HEMMLEB M., WERITZ F., SCHIEMENZ A., GROTE A., MAIERHOFER C.: Multi-spectral data acquisition and processing techniques for damage detection on building surfaces. In *ISPRS, Com. V Symposium, Dresden* (2006). 25.-27.9. 2006.
- [HWSM06] HEMMLEB M., WERITZ F., SCHIEMENZ A., MAIERHOFER C.: Schadensdiagnose an Bauwerksflächen mit multispektralen Methoden. In *Bauwerksdiagnose 2006* (2006), vol. P08, pp. 277–286. DGZfp-Berichtsband 100-CD.
- [HWWM04] HEMMLEB M., WERITZ F., WILSCH G., MAIERHOFER C.: Multispektraltechniken für die Schadensklassifizierung an Bauwerksflächen. In *Tagungsband zum Feuchtag 2004 mit Workshop ON-SITEFORMASONRY* (2004).
- [Kra96] KRAMER H.: *Observation of the Earth and Its Environment, Survey of Missions and Sensors*, 3 ed. Springer Verlag Berlin Heidelberg, 1996.
- [Ler01] LERMA J.: Multiband versus multispectral supervised classification of architectural images. *Photogrammetric Record* 17, 97 (2001), 89–101.
- [LRB00] LERMA J. L., RUIZ L. A., BUCHON F.: Application of spectral and textural classifications to recognize materials and damages on historic building facades. In *International Archives of Photogrammetry and Remote Sensing* (Amsterdam, 2000), vol. XXXIII, Part B5, pp. 480–483.
- [SSG90] STRACKENBROCK B., SACHER G., GRUNICKE J.-M.: Image processing for mapping damages to buildings. In *Proceedings of the XIII. International CIPA symposium* (Cracow, 1990), p. 7.
- [Wig02] WIGGENHAUSER H.: Active ir-applications in civil engineering. *Infrared Physics and Technology* 43 (2002), 233–238.