



VSMM 2008 – Digital Heritage – Proceedings of the 14th International Conference on Virtual Systems and Multimedia



Digital Heritage

Proceedings of the 14th International Conference on Virtual Systems and Multimedia

Short Papers



This volume contains the Short Papers presented at VSMM 2008, the 14th International Conference on Virtual Systems and Multimedia which took place on the 20 to 25 October 2008 in Limassol, Cyprus. The conference title was “Digital Heritage: Our Hi-tech-STORY for the Future, Technologies to Document, Preserve, Communicate and Prevent the Destruction of our Fragile Cultural Heritage”.

The conference was jointly organized by CIPA, the International ICOMOS Committee on Heritage Documentation and the Cyprus Institute. It also hosted the 38th CIPA Workshop dedicated on e-Documentation and Standardization in Cultural Heritage and the second Euro-Med Conference on IT in Cultural Heritage. Through the Cyprus Institute, VSMM 2008 received the support of the Government of Cyprus and the European Commission and it was held under the Patronage of H. E. the President of the Republic of Cyprus.



20–25 October 2008
Limassol, Cyprus

M. Ioannides, A. Addison, A. Georgopoulos, L. Kalisperis (Editors)

VSMM 2008

Digital Heritage

Proceedings of the 14th International Conference on Virtual Systems and Multimedia

Short Papers



20–25 October 2008
Limassol, Cyprus

M. Ioannides, A. Addison, A. Georgopoulos, L. Kalisperis (Editors)

Marinos Ioannides
Editor-in-Chief

Elizabeth Jerem
Managing Editor

Fruzsina Cseh, Elizabeth Jerem
Copy Editors

ARCHAEOLINGUA
Cover Design

“The paramount significance of their (the Kanakaria mosaics’) existence,” said Judge Noland in the Federal Court in Indianapolis, “is as part of the religious, artistic and Cultural Heritage of the Church and the Government of Cyprus, and as part of the national unity of the Republic of Cyprus.”

A Case Study in the Preservation of Cultural Heritage in Times of War The Kanakaria Mosaics (6th century AD)

Photos by Ioannis Iliades, Curator of the Byzantine Museum in Lefkosia, Cyprus.

On the eastern tip of the Karpass (Karpasia) peninsula of the island of Cyprus, lies a small village, Lythrangomi (Lythragkomi). The church of Panayia Kanakaria (dedicated to Virgin Mary) at Lythrangomi, suffered from one of the worst examples of looting as a result of war.

Before 1974, when Turkey invaded Cyprus, the Kanakaria church mosaics were regarded as being among the most important and some of the very few surviving examples of early Christian art.

Early in 1989, however, four Kanakaria mosaics - depicting the child Christ (picture in the cover), an archangel and the Apostles James and Matthew - appeared in the U.S., where they were offered by an art dealer to the Getty Museum for \$20,000,000.

The Cyprus Government and Greek Orthodox Church immediately sued the US dealer, who, in front of a US District Court, claimed to have bought the mosaics from a Turkish art dealer. The action of the Government and the Church, supported by a petition of 2,000 prominent US academics and cultural figures, was vindicated when the Court ruled that the mosaics should be returned to the rightful owners.

Source (accessed 02.10.2008):

- <http://www.greekvillage.com/hcaao/kanakaria.html>
- <http://www.brown.edu/Departments/Classics/bcj/15-07.html>
- <http://www.jstor.org/pss/2847685>
- <http://www.europesworld.org/EWSettings/Article/tabid/191/ArticleType/ArticleView/ArticleID/20454/Default.aspx>
- <http://www.middleeastinfo.org/forum/index.php?showtopic=7950>

This work is subject to copyright.

Permission to make digital or hard copies of portions of this work for personal or classroom use is granted without fee, provided that the copies are not made or distributed for profit or commercial advantage and that the copies bear this notice and the full citation on the first page. Copyright for components of this work owned by others must be honored. Abstracting with credit is permitted. To otherwise reproduce or transmit in any form or by any means, electronic or mechanical, including photocopying, recording, or by any information storage retrieval system or in any other way requires written permission from the publisher.

© 2008 by The International Society on Virtual Systems and MultiMedia (VSMM Society) and individual authors

ISBN 978-963-9911-01-7

Published by ARCHAEOLINGUA
Printed in Hungary by PRIMERATE
Budapest 2008



ARCHAEOLOGIA



VSMM 2008

Digital Heritage Proceedings of the 14th International Conference on Virtual Systems and Multimedia

20–25 October 2008

LIMASSOL, CYPRUS

Conference Chair

Marinos Ioannides CY

Co-Chairs of the International Scientific Committee (ISC)

Andreas Georgopoulos GR, Loukas Kalisperis CY/USA, Alonzo Addison USA

Paper Review Chair

Andreas Lanitis CY

Workshop Chair

Denis Pitzalis FR

Local Organizing Committee

Yiorgos Chrysanthou	Andreas Hadjiprokopis	Andreas Lanitis	Stratos Stylianidis
Christis Z. Chrysostomou	Achilleas Kentonis	Anna Marangou	Georgos Stylianou
Ioannis Eliades	Andrew Laghos	Antonis Maratheftis	Kyriakos Themistokleous
Diofantos Hadjimitsis	Christos Lambrias	Demetrios Michaelides	Marina Tryfonidou

International Scientific Committee

Abdelaziz Abid, FR	Adel Danish, EG	Wassim Jabi, USA	Mario Santana Quintero, BE
Alonzo Addison, USA	Rob Davies, UK	Loukas Kalisperis, CY/USA	C. Renaud, FR
Orhan Altan, TR	Andy Day, UK	Sarah Kenderdine, AU	Julian D. Richards, UK
Angelos Amditis, GR	Martin Doerr, GR	Timo Kunkel, UK	Seamus Ross, UK
Alfredo Andia, USA	Michael Doneus, AT	Marios Kyriakou, CY	Nick Ryan, UK
David Arnold, UK	Pierre Drap, FR	Eleni Kyza, CY	Robert Sablatnig, AT
Alessandro Artusi, IT	Sabry El-Hakim, CA	Andrew Laghos, CY	Fathi Saleh, EG
Manos Baltsavias, CH	Ioannis Eliades, CY	Christos Lambrias, CY	Donald H. Sanders, USA
Juan A. Barcelo, ES	Dieter W. Fellner, AT	Andreas Lanitis, CY	Pasquale Savino, IT
Richard Beacham, UK	Maurizio Forte, IT	Celine Loscos, UK	Michael Scherer, DE
Anna Bentkowska-Kafel, UK	Bernard Frischer, USA	Jose Luis Lerma, ES	Holly Schlaumeier, UK
J-Angelo Beraldin, CA	Sakis Gaitatzis, CY	Katerina Mania, GR	Roberto Scopigno, IT
Niels Ole Bernsen, DK	Andreas Georgopoulos, GR	Keith May, UK	Stratos Stylianides, CY
Massimo Bertocini, IT	Luc Van Gool, CH	Despina Michael, CY	Georgos Stylianou, CY
Nicoletta Di Blas, IT	Stephen M. Griffin, USA	Demetrios Michaelides, CY	Nadia M. Thalmann, CH
Jan Boehm, DE	Pierre Grussenmeyer, FR	David Mullins, IE	Juan Carlos Torres, ES
Paul Bourke, AU	Norbert Haala, DE	Christiane Naffah, FR	Olga De Troyer, BE
Rosella Caffo, IT	Diofantos Hadjimitsis, CY	Massimo Negri, IT	Marina Tryfonidou, CY
Panagiotis Charalambous, CY	Klaus Hanke, AT	Steve Nickerson, CA	Nicolas Tsapatsoulis, CY
Stavros Christodoulakis, GR	Sven Havemann, AT	John Mackenzie Owen, NL	Giorgio Verdiani, IT
Yiorgos Chrysanthou, CY	Sorin Hermon, IT	George Papagiannakis, CH	Maria Luisa Vitobello, IT
Christis Z. Chrysostomou, CY	Jeremy Huggett, UK	Petros Patias, GR	Krzysztof Walczak, PL
Paolo Cignoni, IT	Marinos Ioannides, CY	Sumanta Pattanaik, USA	Aloysius Wehr, DE
Sabine Coquillart, FR	Babis Ioannidis, GR	Denis Pitzalis, FR	Martin White, UK
Andrea D'Andrea, IT	Charalambos Ioannidis, GR	Daniel Pletinckx, BE	
Uzi Dahari, IL	Yiannis Ioannidis, GR	Chryssy Potsiou, GR	



Under the Patronage of H.E. President of the Republic of Cyprus

Cyprus Government

In cooperation with



Cyprus Government



Department of Antiquities in Cyprus



International Council on Monuments and Sites
Conseil International des Monuments et des Sites



CYPRUS NATIONAL COMMISSION FOR UNESCO



In cooperation with European Union Projects



CHIRON



COINS



Institutional Sponsors



United Nations Educational, Scientific and Cultural Organization



With the support of UNESCO's Culture Sector



Ministry of Education & Culture



University of Cyprus



Supporters



The official carrier of the joint event



Acknowledgements and Disclaimer

The VSMM 2008 joint conference has been partly supported by the VSMM Society, the Cyprus Government, the Cyprus Institute, The Cyprus University of Technology and the University of Cyprus.

The 38th CIPA International Workshop has been supported by CIPA, ISPRS and ICOMOS.

The 2nd EuroMed Conference has been supported by UNESCO-Cyprus Committee and the Cyprus Government.

However, the content of this publication reflects only the authors' views and the European Commission, Cyprus Government, VSMM Society, CIPA, ISPRS, ICOMOS, the Cyprus Institute, The Cyprus University of Technology and the University of Cyprus are not liable for any use that may be made of the information contained in this proceeding.

Foreword

These conference proceedings contain a selection of papers that focus on multi-disciplinary research involving both Cultural Heritage (CH) Informatics and also the use of technology for initial data-capture and digitization, information data-processing, reconstruction, modelling, visualization, documentation and archiving, as well as visualisation of results and dissemination to the scientific and cultural-heritage communities and to the public. The contributions in these proceedings will definitely assist all experts involved in Cultural Digital Heritage in restoring, renovating, protecting, documenting, archiving, and monitoring history and prehistory, to secure this information for years to come. It is clear that a worldwide collaboration in this area will help make the past accessible to the present and the future.

Cultural Heritage is being transformed by the nature of digital representation of culture in which production, documentation, and distribution of an artefact are one and the same. Understanding and defining digital cultural heritage has implications for documentation practices and the experience of cultural institutions.

Digital devices provide unique access to archives and cultural exhibits, enhancing the capacity of museums and collections to encourage community building and civic engagement. Collection databases once used solely by museum professionals are now being made available locally and globally through the Web. Increasingly, access to cultural heritage is digital and experienced through electronic images and facsimiles. Digital tools and information and communication technologies are merging as the basis for preserving cultural heritage. Digital 3D modeling provides precise and complete documentation of cultural heritage objects and sites and should be used in conjunction with traditional techniques. Of great interest to the scientific community in the last few years, especially in the areas of architecture and preservation, are 3-D modeling, visualization and animation of cultural-heritage monuments and sites. The cooperation between photogrammetry and computer graphics has led to the development of new tools and techniques that are particularly useful for the documentation and archiving of cultural heritage in a digital format. These new tools and techniques include not only photogrammetry, but also 3-D reconstruction, visualization, animation and virtual reality. Technical achievements in modeling, rendering, and animation have made possible the creation of virtual environments, providing a convincing visual experience of cultural heritage structures and sites.

The island of Cyprus is a particularly appropriate venue for a conference on Virtual Systems and Multimedia dedicated to CH because of the long and rich pre-history and history of the island. The historical and archaeological context of Cyprus is the physical and ideal setting of this conference. The past story of Cyprus is the history of the interaction of the cultures and peoples of the lands surrounding the Mediterranean Sea, which was the central means of communication, transport, trade and cultural exchange between diverse peoples. Its history is important to understanding the origin and development of the Mesopotamian, Egyptian, Persian, Phoenician, Jewish, Greek, Roman, Arab and Ottoman cultures and, hence, is important to understanding the development of Western civilization as we understand and experience it today.

The roots of cultures and civilizations are embodied in their architectural structures and archaeological sites, and this cultural heritage should be preserved for future generations. The importance of preservation can be seen in the efforts of international organizations to document important structures and sites. UNESCO and ICOMOS have called for all national and international organizations that are responsible for manmade monuments to document cultural-heritage objects and sites with methods that include traditional and newer, innovative technologies. The integration of these technologies offers great promise and the use of digital technology in particular has rapidly changed documentation techniques.

The importance of Digital Cultural Heritage is evident by the participation and cooperation of a large number of people and organizations including the following:

- The 14th International Conference on Virtual Systems and Multimedia VSMM 2008, dedicated on Digital Heritage (<http://www.vsmm.net/>)
- The 38th CIPA International Workshop dedicated on e-Documentation and Standardization in Cultural Heritage (<http://cipa.icomos.org>)
- The 2nd Euro-Med Conference on IT in Cultural Heritage.

We extend our thanks to all those, whose labour, financial support, and encouragement made this joint event possible. The International Program Committee, whose members represent a cross-section of Archaeology, Computer Graphics and Design, Architecture, Surveying, History and Engineering worked tenaciously and finished their work on time.

Especially Mr. Nikolas Valerkos, who designed and managed the webpage and Dr Andreas Lanitis who supervised the web-based submission system and guided the effort that published these proceedings. We would like also to express our gratitude to our co-organizers The Cyprus Institute, the Department of Antiquities in Cyprus and the Technological University of Cyprus. Finally, our institutional sponsors, the Ministry of Education and Culture, the University of Cyprus; and our official carrier, Cyprus Airways who provided money and 'gifts of kind' that made the conference possible.

Our Keynote Speakers, Javier Hernandez-Ros, European Commission, John Van Oudenaren, World Digital Library, *Library of Congress*, Massimo Negri, Europeana and European Museum Forum; Prof. Donna J. Cox, *University of Illinois at Urbana-Champaign*; Vassilios Tsingas, Elliniki Photogrammetriki Ltd; Kareem M. Darwish and Ahmed El-Shimi, *Cairo Microsoft Innovation Center*, are not only experts in their fields but also visionaries for the future of IT in CH. They promote the e-documentation of the past in such a way for its preservation for the generations to come.

Most of all we would like to thank the Cyprus Government, the European Commission, UNESCO WHC, ISPRS, ICOMOS, VSMM-Society and CIPA, that entrusted us with the task of organizing and undertaking this unique event and wish all participants an interesting and fruitful experience.

*Marinos, Alonzo, Andreas, Loukas
Limassol, Cyprus 2008*

CONTENTS

Data Acquisition and Remote Sensing in Cultural Heritage

3D Mapping Using Model Helicopter and Laser Scanning: Case Study Activities of the Laboratory of Photogrammetry and Remote Sensing, Aut	1
<i>P. Patias, O. Geogoula, D. Kaimaris, Ch. Georgiadis, S. Stylianidis, A. Stannas</i>	
Development of the Methodology and Recommendations on Terrestrial Laser Scanning for Russian Landmarks	6
<i>D. Roy</i>	
3D Data Capture and Visualization of Archaeological Pottery	11
<i>A. L. Martínez Carrillo, M. A. Rubio Paramio, J. I. Navas Lara</i>	
Recording and Managing the Archaeological Heritage in the Brussels Capital Region, Belgium - A Challenge for the Future	15
<i>A. Degraeve</i>	
Architectural Information Modelling for Virtual Heritage Application	18
<i>P. Pauwels, R. Verstraeten, R. De Meyer, J. Van Campenhout</i>	
Contemporary Digital Methods for the Geometric Documentation of Churches in Cyprus	24
<i>A. Georgopoulos, Ch. Ioannidis, Ch. Cryssostomou, S. Ioakim, N. Shieittanis</i>	
Bringing Back the Lost Monument: Interactive Virtual Model of Sompur Mahavihara, Bengal	30
<i>Md M. Rashid, H. Rahaman</i>	

Cultural Heritage Resource Information Systems

Nemo System: New Museum Approaches - Development of Portable Navigation Systems for Exhibitions	39
<i>M. Charakis</i>	
The Influence of Virtual Environment Technologies on Estimating Object Sizes and Colours	43
<i>I. Heldal, L. Bråthe, B. Stahre, R. Schroeder, A. Steed</i>	
Teaching “Hi-Tech-Story”: A Webquest for Higher Order Thinking Skills	49
<i>A. G. Vandarakis, K. M. Staral, S. J. Noel</i>	
The Use of 3D-Scanning for the Structural Analysis of Masonry Vaults – A Case Study on the Saint-James Church	53
<i>B. Van Genechten, M. Santana Quintero, L. Schueremans</i>	

Documenting and Preserving Cultural Heritage for the Web

The Material Description and Classification in Nephel System for Artwork Restoration	63
<i>M. Beneš, B. Zitová, J. Hradilová, D. Hradil</i>	
Comparative Experimentation and Verification Experience-Type Educational Materials and Display-Type Educational Materials	68
<i>H. Suzuki, A. Ishida</i>	
Virtual Reality Web Collaborative Environments in Archaeology	74
<i>M. Forte, E. Pietroni</i>	
Collaboration Need Between South and North Korea for Cultural Heritage Digital Archiving	78
<i>H.-J. Lee</i>	
Integration of High-Resolution Tiled Pyramidal Tiff Images of Old Glass Negatives in an Online Photo Library for Consultation, Research and Conservation	84
<i>E. Buelinckx, H. Opstaele</i>	

Digital Museums and Libraries

The Currently Feasibility of Conservation Concept	93
<i>S. K. Nassar, S. S. Abdalla</i>	
Text Recognition in Both Ancient and Cartographic Documents	98
<i>N. Zaghden, B. Khelifi, A. M. Alimi, R. Mullot</i>	
Complexity, Ambiguity and Uncertainty: A User-Centred Approach to Maximising Access and Use of Event-Based Cultural Heritage Data	102
<i>S. Brown</i>	
Marketing Heritage: Guided Through the Past Using GPS Navigation Technologies	109
<i>D. G. Hadjimitsis, K. Themistocleous</i>	

Spatial Information Management for Cultural Heritage

Development and Use of a 4D GIS to Support the Conservation of the Calakmul Site (Mexico, World Heritage Programme)	117
<i>M. van Ruymbekke, V. Tigny, E. De Badts, R. Garcia-Moreno, R. Billen</i>	
Photo Browsing System for Sharing Information in Archeological Research	122
<i>Y. Takata, I. Kanaya, K. Sato</i>	
Integrating Satellite Remote Sensing and Spectro-Radiometric Measurements for Monitoring Archaeological Site Landscapes	124
<i>D. G. Hadjimitsis, K. Themistocleous, M. Ioannides, C. R. I. Clay</i>	

Cultural Heritage Resource Information Systems

Turning the Pages 2.0: Developing a Browser-Based Application for High-Resolution 3D Modelling of Books, Maps and 3D Artefacts	133
<i>M. Stocking</i>	
The History of Commandaria: Digital Journeys Back to Time	139
<i>K. Papadopoulou, N. Tsapatsoulis, A. Lanitis, A. Kounoudes</i>	
From the Ice Age to the Present – An Audiovisual and Tactile Model of the Swedish Region Göta River Valley	146
<i>L. Thuvander, P. Stenborg, J. Ling, C. Sevara, M. Söderström, J. Tornberg</i>	
Restoration of Aged Photos by Color Transplant	152
<i>A. Del Mastio, F. Uccheddu, V. Cappellini</i>	
Physics and Chemistry Applied to the Virtual Restoration of Paintings	158
<i>A. Zymła, P. Callet, S. Dumazet, Z. Sarol, B. Moreno Maso</i>	
Preparing Dariah	164
<i>P. Constantopoulos, C. Dallas, P. Doorn, D. Gavrilis, A. Gros, G. Stylianou</i>	
The Palazzo Della Ragione in Padua: Representation and Communication of Art, Architecture and Astrology of a Civic Monument	167
<i>M. Borgherini, E. Garbin</i>	

Data Modeling and Measuring Cultural Heritage

Cultural Heritage, Enhanced Documentation, Geographic Web, Communities and Data Sharing. Toward the Next Step in Information Management and Dissemination	177
<i>G. Verdiani, M. Nicolodi</i>	
Indexing Heritage Documents in Encyclopedias Using Optimized Named Entity Recognition Techniques	183
<i>D. Raj, R. Sanyal</i>	
Registration of Ancient Manuscript Images Using Local Descriptors	188
<i>M. Diem, R. Sablatnig</i>	
Designing “Typical Knowledge” Repertoires. The Case of Chinese Intangible Heritage “Active-Action”	193
<i>E. Lupo</i>	
Building the Encyclopedia of Life	198
<i>G. Higley</i>	
EuropeanaLocal: Its Role in Improving Access to Europe’s Cultural Heritage Through the European Digital Library	202
<i>R. Davies</i>	

Digital Reconstruction and 3D Modeling

The Digital Archaeological Reconstruction of the a Famosa Fortress, Malaysia	209
<i>M. I. Zainal Abidina, A. Bridges, A. Razak</i>	
Visual Appearance of a Middle Age Sculpture. Polychromy and Lighting Simulation	215
<i>S. Dumazet, P. Callet</i>	
Rapid Prototyping & Cultural Heritage. The Case Study of Loggia Del Mercato Nuovo in Florence	220
<i>C. Battini</i>	
3D Colonial Philadelphia: Digital Documentation and Recreation of American Heritage	225
<i>C. P. Redmann</i>	
Playing “Doll House” in the Museum: The Use of 3D Scanning and Rapid Prototyping Techniques for Producing Scale Models of Sculptures	229
<i>G. Celami, R. Pupo, V. Piccoli, J. V. L. da Silva, M. F. Oliveira, A. Jardini, L. Cancherini, S. Skoda, e R. Marques</i>	
A Historical Landscape at the Crossroads of Cultures: A Digital Landscape at the Crossroads of Computer-Aided Reconstructions and GIS Approaches	234
<i>E. Jerem, J. Laszlovszky, P. Szabó, Zs. Vasáros, Zs. Végvári</i>	

Virtual Reality Applications in Cultural Heritage

The Augmented Digital Reconstruction of a XVII Century Convent in Brazil	243
<i>A. Raposo, S. I. Byington</i>	
Immaterial and Pervasive Storytelling	249
<i>R. Trocchianesi</i>	
Framework Methodology for Virtual Museums for the Design of Visiting Scenarios Based on the Behaviour of Real Exhibition Visitors	253
<i>F. Kiss, M. Török</i>	
Using Games to Preserve and Educate	258
<i>A. Laghos</i>	
Evaluation of Digital Artifact Design at the Interactive Salon	264
<i>C. P. Gottlieb, D. Nilsson, H. Gottlieb</i>	
A Digital Exhibition of the History of the Olympic Games in Antiquity	269
<i>A. A. Katsikas, Ch. G. Venetopoulos</i>	
Virtual Sambor Prei Kuk: Weaving the Tangible and Intangible Cultural Heritage	273
<i>S. Lam, Y. E. Kalay, D. Mitchon, Y. Perez, S. Hong</i>	

Documenting and Preserving Cultural Heritage for the Web

Introduction of Aratta as a Collaborative Research Tool for Iranian Architectural History	281
<i>E. Khazraee, H. Malek, H. Forghani</i>	
An Interactive Poster Kiosk for Public Engagement in Cultural Heritage Displays	287
<i>W. Jabi, T. Hall</i>	
Web Services and Network Technologies for Copyright Protection and Management of Digital Heritage	292
<i>D. K. Tsolis, T. S. Papatheodorou</i>	
Abm – Search Pilot Project	298
<i>B. O. Dahl</i>	

Virtual Reality Applications in Cultural Heritage

A Contact-Less Interactive Tool for Exploring Archaeological Data	305
<i>F. Frangeskides, A. Lanitis, G. Papantoniou</i>	
Virtual Reality Reconstruction and Visualization to Preserve Cultural Heritage: Santimamiñe, a Successful Case	311
<i>S. Barrera, U. Baeza, A. Otaola</i>	
Street Games: Preserving Culture Through Gaming	316
<i>D. Polydorou</i>	
New Narrative Technologies: A Dialectical Approach. Speaking To - Calling For - Talking About	320
<i>A. Spagnoli</i>	
ISEE: Accessing Relevant Information by Navigating 3D Interactive Virtual Environments	326
<i>L. Pecchioli, M. Carrozzino, F. Mohamed</i>	
Information Support System for Museum on Base Bluetooth Technologies	332
<i>A. G. Finogeeva, V. A. Maslova, A. A. Finogeeva, K. A. Bukin</i>	
Effective User-Centered Design for the Vindolanda Interactive Multimedia Application	337
<i>E. Carillo, K. Rodriguez-Echavarria, R. Heath, D. Arnold</i>	

Graphics Applications and Visualization Techniques

On Rendering 3D Archaeological Visualisations	347
<i>A. J. Rigby, M. Melaney, K. Rigby</i>	
Retouching and Frame Reconstruction of Depth Image for Autostereoscopic Monitors	350
<i>S. Ozawa, T. Abe, N. Naruto, M. Ogawara, M. Hirano, K. Tanaka</i>	
Tangible 3D Interface for Sound Manipulation	356
<i>M. Hirabayashi, T. Kobayashi, T. Shimizu, N. Nagano</i>	
Infosphere: One Artefact, Two Metaphors, Three Sort Criteria	362
<i>J. Y. Blaise, I. Dudek, T. Driscu</i>	
LIBVIZ: Data Visualisation of the Old Library	368
<i>K. Ruhland, M. Sedlmair, S. Bioletti, C. O'Sullivan</i>	
3-Dimensional Holographic Representation of Museum Objects	374
<i>V. Tornari, E. Tsiranidou, K. Hatziyannakis</i>	
A Visualization Tool for Cross-Linking Multiple Classification Hierarchies for Historic Costume	377
<i>K. Martin</i>	

Data Acquisition and Remote Sensing in Cultural Heritage

3D MAPPING USING MODEL HELICOPTER AND LASER SCANNING: CASE STUDY ACTIVITIES OF THE LABORATORY OF PHOTOGRAMMETRY AND REMOTE SENSING, AUT

Patias, P., Geogoula, O., Kaimaris, D., Georgiadis Ch., Stylianidis, S., Stamnas, A.

Laboratory of Photogrammetry and Remote Sensing, Faculty of Rural & Surveying Engineering, The Aristotle
University of Thessaloniki, Univ.Box. 473, 54124, Greece, patias@auth.gr,
Tel +30-2310-996116, Fax +30-2310-996128, Univ Box 473, GR-54124 Thessaloniki

KEY WORDS: UAV, laser scanning, 3D mapping, archeological sites

ABSTRACT:

This study presents a number of showcases of documentation of archaeological sites using a model helicopter, laser scanning and photogrammetric software. These showcases present the activities of the Laboratory of Photogrammetry and Remote Sensing at the Department of Rural and Surveying Engineering, The Aristotle University of Thessaloniki.

1. UNMANNED AUTONOMOUS VEHICLE FOR AERIAL PHOTOGRAPHY

The recording and documentation speed, combined with cost, waiting time inside the field and final product accuracy, is a factor that is always largely taken into account in a plethora of Photogrammetric applications.

During the last years, and to that aim, Unmanned Autonomous Vehicles for aerial photography, that permit the collection of images with objects from earth at a large scale, were developed. Thus, they can contribute to a range of applications, such as excavations and archaeological sites recording, architecture etc.

The advantages of these systems are:

- Use of low cost and low weight gyroscopes, GPS, INS, etc, that are used for the creation of programs of automatic navigation and collection of aerial photographs
- Additional exploitation of higher accuracy sensors that allows for the estimation of the orientation elements of the camera, thus decreasing the time of the photogrammetric procession of data.
- Creation of the base of the photographic system in a way that allows for various cameras to adjust, thus ensuring a variety of spectral images.
- Capacity of immediate flight, even in areas that -mainly for military reasons- the flight of airplanes and helicopters is not permitted.

The disadvantages of these systems are:

- Limitation of the geographic recording area because of the low flight height that does not exceed 100m
- Flying capacity is guaranteed only when wind force does not exceed 3 in the Beaufort scale.
- Flying autonomy does not exceed the time limit of 15min.

2. CURRENT SYSTEMS

The UAVs are usually used for military purposes. However, during the last years, they are also utilized for photogrammetric

applications. To that aim, a number of programs, in which a flight path with flight strips and the height of the flight are defined, have been developed. Then, the operator has only to get the helicopter or the airplane off the ground, and the flight is automatically performed. The systems are equipped with GPS/INS and flight control system stabilization units, which are used only in order to "place" the helicopter in predicted intake positions. The photogrammetric processing requires time since the sensors do not ensure a high level of accuracy in defining the orientation elements of the images taken. Thus, it is imperative for Control Points to be measured on the ground with GPS receivers (web 1, Eisenbeiss 2004ab, Jizhou *et al.* 2004, Eisenbeiss *et al.* 2005, Eisenbeiss and Zhang 2006, Hongoh *et al.* 2001, Schwarz and El-Sheimy 2004).

In order to address the decreased flying autonomy of those systems, photovoltaic systems for the collection of solar energy and the fuelling of the motor have been adjusted in specific parts of the unmanned vehicles.

3. THE UAV SYSTEM OF THE LABORATORY OF PHOTOGRAMMETRY AND REMOTE SENSING OF THE ARISTOTLE UNIVERSITY OF THESSALONIKI, GREECE

The Unmanned Autonomous Helicopter (pic. 1) of the Laboratory of Photogrammetry and Remote Sensing of the Department of Surveying Engineering of the Aristotle University of Thessaloniki, Greece, is a model created by a company called VARIO and has a lifting power of eight (8) kilos. Its main characteristics are presented in picture 2 and some of its parts are: a Novarossi C60H4T engine, a Futaba T7CP remote control, a Futaba GY401 gyroscope, Futaba S3151/S9253 servomechanisms, a helicopter battery charging unit, rechargeable lead batteries, a starting motor, etc.

On the bottom of the helicopter is the base of the photography equipment. In order to absorb the buffeting created during the flight, the base is connected to the frame of the helicopter through silicon plates. A digital 5Mp camera has also been adjusted (Olympus C-50 Zoom) as well as a wireless mini camera for the observation of the screen during the flight.

Through a TV card connected to a laptop, the image taken by the mini-camera is transferred to its screen. Thus, the study team observes the objects of the ground that can be photographed in real time. In knowing the source distance and the machine analysis, the flight height and the distance of the succeeding take points is defined according to the accuracy of the final product, in order to collect stereoscopic images. The helicopter is supervisory guided to these points. A servomechanism, located to the base and in contact with the machine take button, allows the collection of the images while the helicopter position covers all demands.



Figure 1: RC helicopter

Μήκος		1,39 m
Πλάτος		0,15 m
Ανοιγμα Έλικα		1,53 m
Βάρος		5,10 Kgr

Figure 2: Main characteristics of the helicopter

4. FUTURE WORK

The main target of the study team is the automation of the photogrammetric recording, though the improvement and optimisation of the existing unmanned autonomous helicopter. Thus, the designing and the development of a low cost complete inertial system (gyroscopes, Micro -machined Electro/Mechanical Systems accelerometers, GPS, a.o.), small and light weighted, is awaited in order to define the taking angles of the digital camera. Consequently, the time needed for the procedures of the images' external orientation, the time needed for the image and data processing and finally the production of photogrammetric products will be decreased. Specialized software for automatic flying will also be designed and developed (Kresse *et al.* 2006, Skaloud 2002, Skaloud and Vallet 2002, Skaloud and Viret 2004, Skaloud *et al.* 2006, Legat 2006, Vallet and Skaloud (2004), Waegli and Skaloud 2007, Eisenbeiss 2004ab, Jizhou *et al.* 2004, Eisenbeiss *et al.* 2005, Eisenbeiss and Zhang 2006, Hongoh *et al.* 2001, Schwarz and El-Sheimy 2004).

Finally, the base of the telescopic systems will be redesigned in a way that allows for the suspension of various cameras.

5. REFERENCES

- Eisenbeiss, H. (2004a): *A mini unmanned aerial vehicle (UAV): System overview and image acquisition*. International Workshop on 'Processing and visualization using high-resolution imagery', Pitsanulok, Thailand. 36(5/W1). (on CD-ROM).
- Eisenbeiss, H. (2004b): *Applications of photogrammetric processing using an autonomous model helicopter*. ISPRS Commission I Symposium, Paris, France, 03-06 July. International Archives of Photogrammetry, Remote Sensing and Spatial Information Sciences, Vol. XXXVI-Part1/B. (on CD-ROM).
- Eisenbeiss, H., Lambers, K., Sauerbier, M. and Zhang, L. (2005): *Photogrammetric documentation of an archaeological site (Palpa, Peru) using an autonomous model helicopter*. International Symposium CIPA 2005 XX, 26 September – 01 October, Torino, Italy 34 (5/C34), Proceedings pp. 238-243 (and on CD-ROM).
- Eisenbeiss, H. and Zhang, L. (2006): *Comparison of DSMs generated from mini UAV imagery and terrestrial Laser Scanner in a cultural heritage application*. ISPRS Commission V Symposium 'Image Engineering and Vision Metrology'. IAPRS Volume XXXVI, Part 5, Dresden 25-27 September 2006, Proceedings pp. 90-96.
- Hongoh, D., Kajiwara, K. and Honda, Y., (2001): *Developing Ground Truth Measurement System using RC Helicopter and BRDF Model in Forest Area*. Proc. ACRS 2001 - 22nd Asian Conference on Remote Sensing, 5-9 November 2001, Singapore. Vol. 1, pp. 59-64.
- Jizhou, W., Zongjian, L. and Chengming, Li. (2004): *Reconstruction of buildings from a single UAV image*. International Archives of Photogrammetry and Remote Sensing, Istanbul, Vol. XXXV, Part B8. (<http://www.isprs.org/istanbul2004/yf/yf.html>)
- Kresse, W., Skaloud, J. and Hinsken, L. (2006): *Requirements for an orientation and calibration standard for digital aerial cameras and related sensors*. 'From Sensors to Imagery' - Symposium of ISPRS Commission 1, Paris, 3-6 July. (http://topo.epfl.ch/personnes/jsk/Papers/ISPRS06_Paris_KresseSkaloud.pdf)
- Legat, K., Skaloud, J. and Schaer, P. (2006): *Real-time processing of GPS/INS data for on-the-fly quality control in airborne mobile mapping*. European Navigation Congress ENC-GNSS, Manchester, 7-10, Proceedings pp. 1-14
- Schwarz, K., P. and El-Sheimy, N. (2004): *Mobile Mapping Systems – State of the art and future trends*. International Archives of Photogrammetry and Remote Sensing Vol. XXXV, Part B5, Commission 5. (<http://www.isprs.org/istanbul2004/comm5/papers/652.pdf>)
- Skaloud, J. (2002): *Direct Georeferencing in Aerial Photogrammetric Mapping*. Photogrammetric Engineering & Remote Sensing, *Journal of Photogrammetry and Remote Sensing*, Vol 68, No. 3, pp. 207-210
- Skaloud, J. and Vallet, J. (2002): *High accuracy handheld mapping system for fast helicopter deployment*. Joint International Symposium on Geospatial Theory, Processing and Applications, ISPRS IV, Ottawa, Canada, July 9-12.
- Skaloud, J. and Viret, P. (2004): *GPS/INS Integration: From Modern Methods of Data Acquisition to New Applications*. European Journal of Navigation. Vol. 2, No. 4, pp. 60-64.
- Skaloud, J., Vallet, J., Keller, K., Veyssiere, G. and Kolbl O. (2006): *An Eye for Landscapes. Rapid Aerial Mapping with Handheld Sensors*. GPS World, vol. May 2006, num. 17 (5), pp. 26-32.
- Vallet, J. and Skaloud, J. (2004): *Development and experiences with a fully-digital handheld mapping system operated from a helicopter*. The International Archives of the Photogrammetry, Remote Sensing and Spatial Information Sciences, Istanbul, Vol. XXXV, Part B, Commission 5. (<http://www.isprs.org/Istanbul2004/comm5/papers/657.pdf>)
- Waegli, A. and Skaloud, J. (2007): *Assessment of GPS/MEMS-IMU Integration Performance in Ski Racing*. European Navigation Congress ENC-GNSS, Geneva, Switzerland, May 29 – June 1.

APPENDIX 1

Case Study 1

Site surveyed	The EPANOMI archaeological site of AUT
Aim	<ul style="list-style-type: none"> ▪ Testing of accuracy, effectiveness and robustness of developed algorithms ▪ Testing of the designed e.o device ▪ Testing of camera calibration procedure ▪ Comparison of aerial and close-range images ▪ Familiarization of archaeologists with the system ▪ Site documentation
Methodology used	<ul style="list-style-type: none"> ▪ Digital images from model helicopter and close-range (Camera used : CANON EOS 400D) ▪ Geodetic measurements of 28 control and check points, with an accuracy of 1 cm. ▪ Processing all photogrammetric data with developed software for comparison reasons between aerial and close-range images
Results obtained	<ul style="list-style-type: none"> ▪ Pixel size of orthophotomap = 1 cm ▪ Acceptable results of mapping at 1: 50 scale
Collaboration with	Prof. Ch. Pazaras, Archaeology Department, AUT

Table 1. Case study 1



Figure 1. Overview of the area



Figure 2. Aerial image



Figure 3. Close range image



Figure 4. Testing the e.o device and the camera calibration

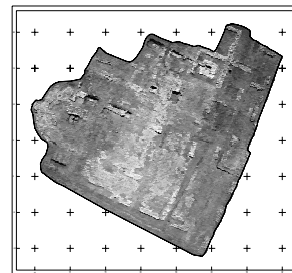
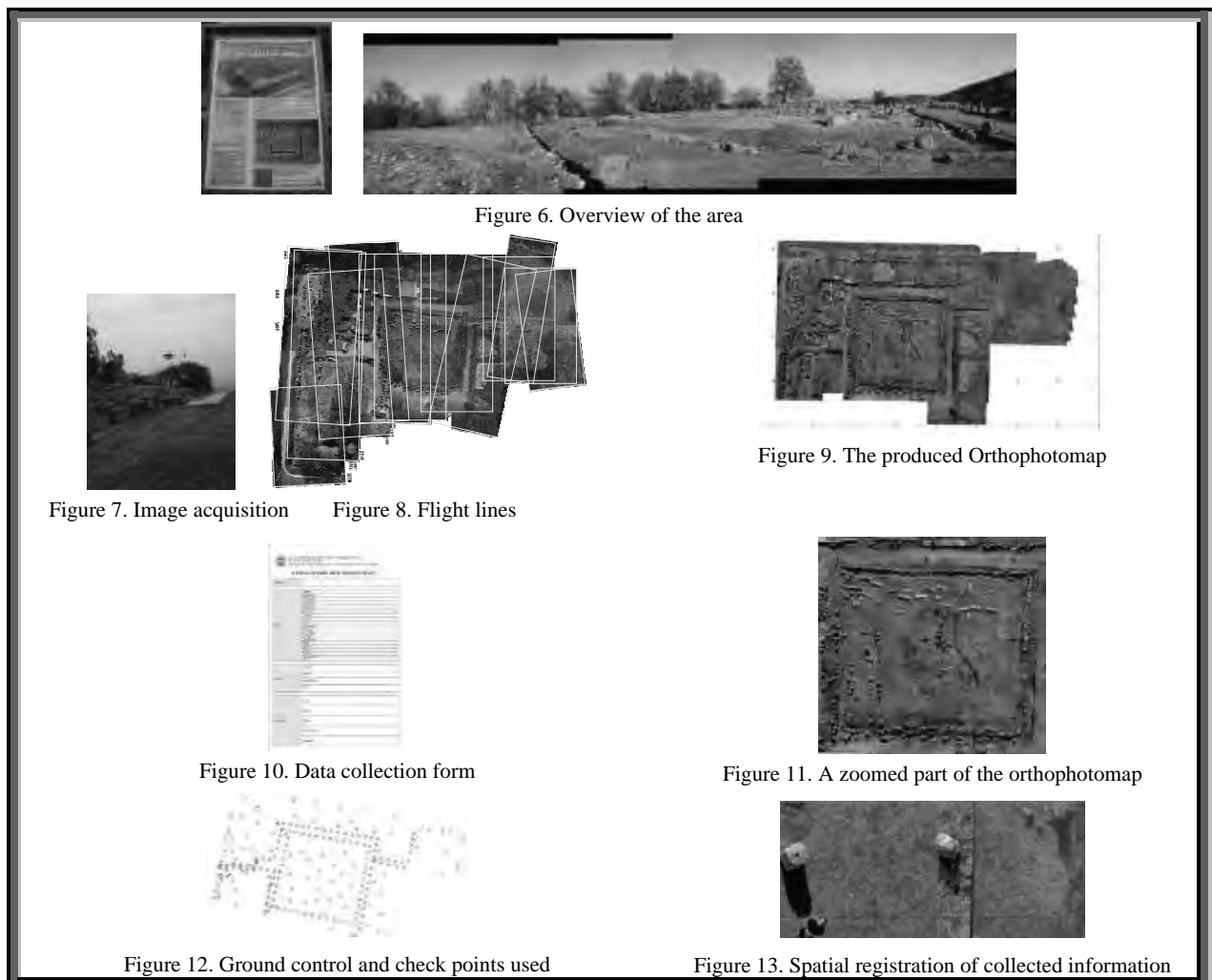

Figure 5. The produced Orthophotomap

Case Study 2

Site surveyed	The Macedonian Palace in Vergina-Aegae archaeological site of AUT
Aim	<ul style="list-style-type: none"> ▪ Testing of accuracy, effectiveness and robustness of developed algorithms ▪ Familiarization of archaeologists with the system ▪ Site documentation
Methodology used	<ul style="list-style-type: none"> ▪ 87 Digital images from model helicopter <ul style="list-style-type: none"> ○ Mean flying height of 30 m ○ Mean scale of images 1: 1.600 ○ Mean ground resolution 1 cm ▪ Geodetic measurements of 70 control and check points, with an accuracy of 2 cm. ▪ Processing of photogrammetric data with both developed software and the commercial Leica Photogrammetry Suite (Leica Geosystems®) for comparison reasons
Results obtained	<ul style="list-style-type: none"> ▪ Discrepancies at check points = 2.5 cm in planimetry and 4.0 cm in height ▪ Pixel size of orthophotomap = 1 cm ▪ Acceptable results of mapping at 1: 100 scale ▪ Data collection for GIS development
Collaboration with	Prof. Chr. Satsaoglou-Paliadeli, Archaeology Department, AUT

Table 2. Case study 2



Case Study 3

Site surveyed	The parcel of the Nicosia Sewerage Board at the old city of Nicosia, Cyprus
Aim	<ul style="list-style-type: none"> ▪ Testing of accuracy, effectiveness and robustness of developed algorithms ▪ Testing algorithm again laser scanning methodology ▪ Familiarization of archaeologists with the system ▪ Site documentation
Methodology used	<ul style="list-style-type: none"> ▪ 30 Digital images from close-range (Camera used : CANON EOS 400D) ▪ Geodetic measurements of 30 control and check points, with an accuracy of 1 cm. ▪ Laser scanning with Trimble GS200 laser scanner (6 scans) ▪ Processing all photogrammetric data with developed software for comparison reasons between photogrammetric documentation and laser scanning
Results obtained	<ul style="list-style-type: none"> ▪ Pixel size of orthophotomap = 1 cm ▪ Acceptable results of mapping at 1: 50 scale
Collaboration with	Dr. E. Stylianidis, Geolmaging Ltd., Cyprus

Table 3. Case study 3



Figure 14. Overview of the area



Figure 15. A crab has been used for image acquisition



Figure 16. Laser scanning data



Figure 17. The produced Orthophotomap



Figure 18. Orthophotomap overlaid by the CAD drawing

DEVELOPMENT OF THE METHODOLOGY AND RECOMMENDATIONS ON TERRESTRIAL LASER SCANNING FOR RUSSIAN LANDMARKS

D. Roy, Restorer-architect

PF-Grado company, Moscow, Russia- dmroy@yandex.ru

KEY WORDS: Terrestrial Laser Scanning, Methodology, Recommendations, Cultural Heritage

ABSTRACT:

Since wide spreading of Laser Scanning technology and its ever-increasing implementation in the field of Historical Preservation, the problem of its methodology and standardization/unification of receiving data has appeared critical in Russia. In this connection in 2007/2008 the PF-Grado company (Moscow) has proceeded with development of Methodology and Recommendations in Use of Terrestrial Laser Scanning (TLS) for Recording/Documenting Spatial Parameters of Landmarks in Moscow (Russia). This work was initiated by the Committee of Moscow Cultural Heritage for obtaining the methodological base in compiling of the Local Register for the Moscow Landmarks. At present, Moscow Local Register contains extensive information on Moscow Landmarks. It is formed and managed by the Committee and used by Historic Preservation specialists. Thereby, the aim was to develop the universal methods, which should be independent from certain commercial software or laser scanning systems, to promote the development and deeper introduction of technology in the field of Historical Preservation. Hereof, the Methodology and Recommendations were built on principle of the collection, processing and archiving data, which could be used easily by different systems today as much as in the future. Current phase of the work is directed to the Landmarks and architectural ensembles. On the further phases the Recommendations are expected to be improved to involve the features of documenting the other types of Historical Preservation Objects, like main street programs, archeological sites, parks, museum artifacts. On the way of Methodology's development some disadvantages of TLS were detected and recommendations upon their compensate with imagery and geodetic methods were formed.

1. INTRODUCTION

1.1 Motivation.

Each project for Historical Preservation begins with gathering of information on any particular landmark, its history and existing condition. At this phase, presence of high quality and entire documentation set about past work, has done on a monument, plays an important role. Also, the choice of the right methods for current measurements and documentation of a work process requires: an efficient project facilities management; quality of information with availability of its future use in maintenance of the object; long-term archiving and simplicity in research.

The main features of good documentation are:

- Content, which has to cover all details about a building and its environment, as well as about all cases of interference to the historical structure;
- Accessibility, safety and simplicity using for researchers and professionals today as well, as in the future.

Through the time, technologies and methods for solution of these problems are improved. Terrestrial Laser Scanning (TLS) became one of such technologies. Many Historical Preservation specialists understand its prospects, once faced with this technology. The technology allows getting precise measurements much faster, than before, and keeping the complete spatial information on object in the united array of a point cloud. This technology significantly simplifies the process of information management and enables getting various data from the same source. And, with correct combination of different methods and technologies, it is possible to accompany the projects with easy in use and comprehensive in contents

documentation, which not only makes the current work easier, but also becomes a great help in future projects.

Considering the increasing popularity of TLS and usage of the technology in measurements of Landmarks more and more, the question about methodical base of these works has appeared critical. Due to high cost of TLS equipment, the Historical Preservation specialists often use the service of companies, who have no relations to the Historical Preservation skill, and therefore have no idea of the delicacy of the question. This factor aggravates the situation and requires the regulations by corresponding standards and recommendations.

1.2 Goals

The Development of the methodology of the using TLS to record Landmarks is important step to accept this technology in of Historical Preservation research routine.

In 2007/2008 the PF-Grado company (Moscow, Russia) has proceeded with development of Methodology and Recommendations in Use of Terrestrial Laser Scanning for Recording/Documenting Spatial Parameters of Landmarks. This work was initiated by the Committee of Moscow Cultural Heritage for obtaining the methodological base in compiling of the Local Register for the Moscow Landmarks. At present, Moscow Local Register contains extensive information on Moscow Landmarks. It was formed and managed by the Committee. Now it is used widely by Historic Preservation specialists.

The intention of PF-Grado was to develop the methods to use TLS for systematic recording Landmarks with possibility to store the data for a long-term. Thereby, directivity of the work was to form universal methods, which should be independent from certain commercial software or laser scanning systems, to

promote the development and deeper introduction of technology in the field of Historical Preservation. Hereof, the Methodology and Recommendations were built on a base of gathering, processing and archiving data, which could be used easily by different systems today as much as in the future.

Current phase of the work is directed to the National Landmarks: buildings and architectural sites. On the further phases the Recommendations are expected to be improved to involve the features of documenting the other types of Historical Preservation Objects, like main street programs, archeological sites, historical landscapes, museum artifacts.

The Recommendations have been developed on a base of studies the international experience of the application the Terrestrial Laser Scanning to the Historical Preservation, as well as upon domestic methodologies and standards, office standards and experience of PF-Grado.

2. PRACTICAL BASE OF THE METHODOLOGY

After many projects completion with Laser Scanner use, PF-Grado got a significant and unique experience with monuments of Cultural Heritage, from the historical town blocks to the museum artifacts. In majority it was buildings and architectural sites.

As any other work, Laser Scanning projects from time to time met problems. Some of them are difficult and the other are not so much. The problems, we faced with, conditionally could be arranged into 4 categories:

1. Complications during a field work. There could be difficulties in access to the object because of any obstacles. Sometimes, there is no access to electrical power at the workplace, and time of each workday depends on presence and values of the charge of local stationary power source. Sometimes it happens to adapt to time schedule on a site (acting businesses in a building, streets with moving cars and people, car parkings, etc.). All these problems are routine ones, changing from one site to another.
2. Problem in obtaining complete and precise data of one or another character, from which office processing depends straight.

So, considering of measured surfaces complication, sizes of object and distances to them, in the most hopeless situation the problem to obtain necessary quality of data could be solved by changing/combining the types of the laser scanners (pulsed, phase or triangulating laser scanner).

If additional raster data are required, it could be obtained from: High Resolution Photography and different methods of photogrammetry (digital photogrammetry, rectified photography, and even algorithms for texturing 3D-models (Figures 1-4)).



Figure 1: Georgyevsky cathedral (Yuryev-Polsky, Russia).



Figure 2: A part of the textured 3D-model.



Figure 3: Metric ortophoto from the textured 3D-model.



Figure 4: Carved limestone block of the cathedral. 3D-model.

3. The problems in the office processing, which could be manifold in daily practice. They depend of numerous factors, as: the hardware capacity/ possibilities; selection of the software, which differs in cost and functionalities; qualification and experience of employees; etc.

Once, in our practice we faced with a problem of the optimal 3D-modelling method. Native software for point clouds processing are developed for industrial necessities, and therefore not completely suitable for us. And, for the needs of 3D-modelling we can use this kind of software only to generate meshes of the complicated surfaces (bas-reliefs, for instance).

When constructing the 3D-models on a base of CAD-drawings, some disadvantages are occur:

- Time increasing because of the technological chain “point cloud > drawing > 3D-model”.
- Some loss in accuracy of the model.

Finally, we decided to use basically a 3D-modelling software, allowing to import /download the point clouds (although in a limited volume). Such software contains a lot of tools for modeling and significantly decreases time to get a final result. Construction a 3D-model directly over a point clouds leads to maximum accuracy. However, even with this methodology it is necessary to combine the following methods:

- The point cloud processing software is used to generate meshes for objects with complex relief
- CAD-drawings of the profiles are often used to construct the extended elements (cornices, for example).



Figure 5: The 18th century homestead (Moscow, Russia).

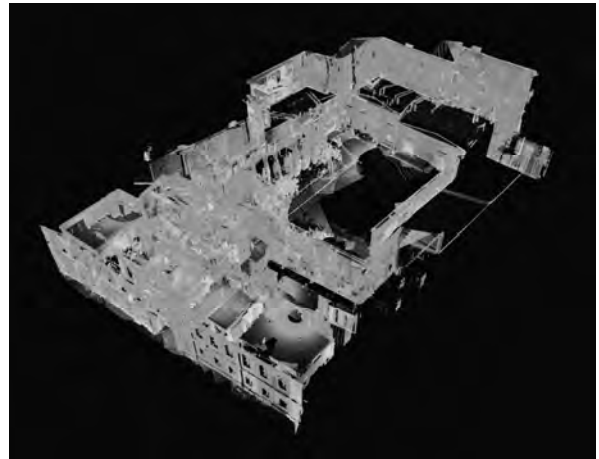

Figure 6: Point cloud of the homestead.

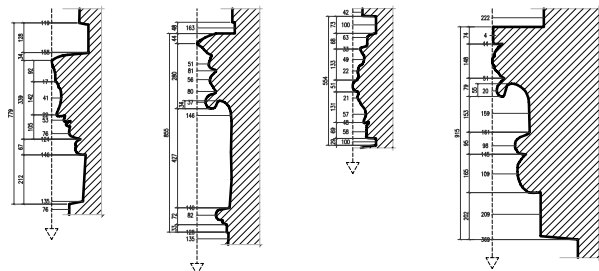

Figure 7: Profiles got from point cloud.



Figure 8: Mesh surface of the bas-relief.



Figure 9: 3D-model of the homestead.

4. The problems in systematization of data are appeared right after the beginning of work with Laser Scanning. The rapid growth of various data appeared obvious. Documentation on the same project was produced by a group of specialists, who had their own vision and system to gathering the data. Looking further, what a chaos it could be in future, the problem to systemize the data became vital. So, the search of an index for the file system was started. The index should be suitable for the entire specter of the project documentation. That kind of system was found (Bryan P. G., Blake B., 2000), but changed along the practice.

Usage of the “open”, so much as the “native” file formats, insofar it is possible, was decided for archival purposes, due to the fact of a great number and fast evolution of the software.

Thereby, on a base of experience and additional searches, the paper on Methodology and Recommendations was formed.

3. METHODOLOGY AND RECOMMENDATIONS

The Methodology and Recommendations are written in simple words and intended to both professionals and clients. The practical value of the paper could be reduced to three main functions: 1. descriptive; 2. reference; 3. normative.

1. The Descriptive function is important not as much for professionals as for the clients. These:

- Objective citation of the negative and positive sides of the Laser Scanning technology
- Description of the events, in which using of Laser Scanning could be motivated, and when it would be more effective to use some another method/technology as the basic or in addition to Laser Scanning.

Understanding these factors is necessary to destroy the myths (existing in a broad public opinion) about unchallengeable advantage of Laser Scanning above the other existent methods, which is not really correct.

2. The Reference function is important for specialists. It is expressed in some technical details of work, as well as the recommendations, directed to optimize the projects in: measurements rate, completeness and accuracy of receiving data, safety for monument and people.
3. The Normative function is directed to unify the data, transmitted to the client. This function is the main, because the Methodology and Recommendations have their direct destination to standard the documentation, produced by different professionals. Here are: some requirements to the list and quality of data (the point clouds, drawings, 3D-models, etc.); standards on file formats; requirements to drawing up the documents, and to a presence and forms of the additional materials (metadata, schemes, picture lists, etc).

The main sections of the Recommendations are “Fieldwork” and the “Office processing” (Figure 10). It corresponds to the typical phases of projects. Both sections are interconnected and have a clear consequent structure, as from the general explanations and recommendations, bring the detailed instructions on methodical and technical questions, meeting in practical realization of the project, and finishing with the requirements to the final data.

The Source materials (drawings, texts, photographs, etc.) are solely important information for qualitative and well-timed work completion. They explain the key aspects, which necessary to pay heed in the course of the project:

- Presence and the description of specifically valuable elements, characteristics, particularities of the object
- A history and construction time periods of a monument
- The lists of coordinates for existing standpoints, if a reference to some curtain coordinate system is required
- Any other information, capable to influence on quality of the work.

Geodetic control is useful to check accuracy of the registrations and is often goes in parallel with scanning. In some situations (complex planning structure of a monument of extensive distances in town blocks), the use of an additional geodetic tool (for instance, Total Station) is necessary. In one case, this could provide saving of time, but sometimes realization of the project is impossible without this.

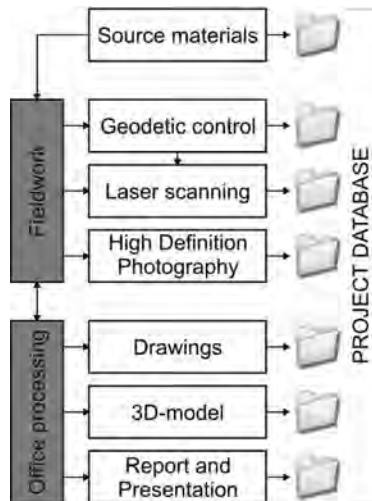

Figure 10: Structure of the Methodology

Additionally to Laser Scanning, in purpose of the visual description of a measured object and its conditions during undertaking its examination and measurements, the High Resolution Photography is necessary. These records can help in recognition of small details and for correction of the losses in a point cloud. The Additional raster data also could help in correct interpretation of visual effects from different materials in a scan. Images can serve as the textures for 3D-modeling if required.

Detailed instructions how to shoot the pictures and how to accompany them with additional materials (schemes, picture lists), are provided in Recommendations.

The questions on systematization and storing data take a very important place in the paper. This topic integrates the "Fieldwork" and "Office processing" sections, which should be a result in a full project database. Considering the different type of materials (point clouds, CAD-drawings, 3D-models, images, schemes, texts, tables, etc.) within, that documentation of project contains with different contents and destination (for instance, texts can contain the metadata of scans and registrations, as well as the data from the geodetic control), the index system for the file names was developed specially for the Laser Scanning projects. The index was accepted on a base, offered in "Metric Survey Specifications for English Heritage" (Bryan P. G., Blake B., 2000). However, to meet the needs of developed Methodology and the project database compound, it was changed in many points.

Except mentioned above, the Methodology and Recommendations contain narrower and more specific problems, such as recording of the construction time periods.

Revealing of a monument construction time periods is one of the most important problems in a field studies. The history of repairs, renewals and the other interference to the structure in most cases becomes a dominant factor in acceptance one or another solution on a preserved monument.

The tools in revealing the construction time periods, such as excavations, making probes, are an inconvertible process, and needs a careful recording on each phase of the work. The Laser Scanning serves as the efficient facility in discovery and spatial

demonstration of the construction time periods. Recording step by step the working process, we get a detailed spatial picture of the discovery and all its findings. This model, displaying with colors, annotations and other tools the special features of the object, helps us in further analysis and interpretation.

At the same way, the construction periods could be shown on a base of the former studies.

4. CONCLUSION

On the first phase of developing the Methodology (concerning the architectural monuments), the number of problems were revealed and the recommendations of its arrangement were formed. Basically the problems, besides from external factors (the weather conditions, obstacles from pedestrians, transportation, etc.) are reduced to technical restrictions of the equipment (the absence or bad quality of the textures, partial disadvantages in georeferencing, some problems with the reflection values of materials, etc.). In most cases such disadvantages are recommended to substitute with other methods and technologies: photogrammetry, geodesy, manual measurements.

In the other projects, new questions, such as influence of a laser beam on different paint pigments and delicate materials, which could be destroyed by the radiation, appear. At validation of this problem, generally accepted indication of the Laser Scanning as the non-contact method of the measurement could be limited in use working with the cultural heritage objects. These problems require additional researches.

Along to arising of new questions and ideas, Methodology is constantly getting renewed and updated. Using TLS for narrow solution restoration/conservation problems, such as historical and structural analysis, needs to be got on stream.

5. REFERENCES

- Bryan P. G., Barber D. M., Mills J. P., 2004. Report from XXth ISPRS Congress "Geo-Imagery Bridging Continents", Istanbul, Turkey. <http://www.isprs.org/istanbul2004/comm5/papers/187.pdf> (accessed 18 Aug. 2008)
- Bryan P. G., Blake B., 2000. "Metric Survey Specifications for English Heritage", English Heritage, Swidon, England. http://www.english-heritage.org.uk/upload/pdf/Metric_Survey_2003_revision_with_links.pdf (accessed 18 Aug. 2008)
- Mills J., Barber D., 2003. "An addendum to the Metric Survey Specifications for English Heritage- the collection and archiving of point cloud data obtained by Terrestrial Laser Scanning and other methods", English Heritage, Swidon, England. www.english-heritage.org.uk/upload/pdf/metric_extraction_scanning_addendum_2.pdf (accessed 18 Aug. 2008)
- Visual Arts Data Service: Grout C., Purdy P., Rymer J. "Creating Digital Resources for the Visual Arts: Standards and Good Practice". http://vads.ahds.ac.uk/guides/creating_guide/contents.html

3D DATA CAPTURE AND VISUALIZATION OF ARCHAEOLOGICAL POTTERY

A.L. Martínez Carrillo¹, M.A. Rubio Paramio² and J.I. Navas Lara²

¹Andalusian Center of Iberian Archaeology, Jaén, Spain

²Department of Graphic Engineering, Design and Projects, Jaén, Spain

KEYWORDS: Archaeological pottery- 3D Models- Visualization

ABSTRACT:

The following article discusses the acquisition and the use of 3D renders for the analysis and study of pottery vessels and shards. This article is based on the work developed at the beginning of the 90's concerning 3D models of shards and vessels, and how these techniques have helped to enhance the quality of archaeological visual analysis (this occupies a large part of the time consumed by archaeological researchers). This article discusses different methods of acquiring, editing and displaying ceramic 3D models. The pros and cons of different methodologies for 3D rendering and analysis are also debated. The aims and purposes of each 3D model are analyzed. The indicators for evaluating each model are: accessibility, user interaction, information about geometric morphology, and the level of automated analysis provided for the study of pottery vessels. Finally, the article explains the methodology used in the implementation of three-dimensional models which is being developed within the CATA project (Archaeological Wheel Pottery of Andalusia in its acronyms in Spanish). The main objective of the project is the implementation of a graphically oriented database which is accessible from the Internet. The database contains different types of information about pottery vessels and fragments found in Andalusia during different periods. The objective of the CATA system is to create a generalized tool which can be applied to any kind of ceramic found in any geographical location.

1. INTRODUCTION AND OBJECTIVES

The use of 3D models in archaeological pottery is an important development in the pictorial or graphical representation of pottery vessels. These images permit the classification and analysis of the different ceramic vessels and fragments documented in archaeological excavations. The interpretation of artefacts in 3D models is an essential step for visual Archaeological analysis of different objects. This article analyses some of the methodologies used to obtain 3D models, giving importance to all the different aspects of this process. Moreover, the methodology used by the CATA project (Archaeological Wheel Pottery of Andalusia in its acronyms in Spanish) is also explained.

In the CATA project a useful tool is being developed to answer to some of the daily problems that archaeologists have to face by using new technologies. The main objective of the project is the creation of a database which provides information about complete vessels, found in the region of Andalusia, made by a potter's wheel. This database can be queried via the Internet, making it a useful tool in comparative research of diverse artefacts found in archaeological excavations. This system combines diverse data (documents, numerical measures, photographs, 2D drawing, 3D models...) in order to add additional tools for the acquisition and retrieval of data.

Since the 90's the development of 3D models has greatly advanced, simplifying the storage of images in digital format. Given the above, 3D scanners along with the visual models should be considered as standard tools in the pottery analysis.

As a complement to image acquisition techniques the storage of pottery images in a database table increases the speed of image retrieval and reduces the time required for the drawing process. It also allows advances into the research done about different forms of producing pottery, and the analysis of uniformity and variability of pottery shapes (Karasik, Smilanski, 2008).

2. METHODOLOGY USED IN THE CONSTRUCTION OF 3D MODELS

Since the 90's a large quantity of work has focused on dealing with the visualisation of diverse aspects of historical heritage through computer methods. The process used in these new information systems are carried out in three steps (Laudon, K.C.; Laudon, J.P., 1996).

- Data acquisition
- Conversion of the data into models
- User data access: visualization and representation.

2.1. Data acquisition

Data acquisition: the process of digitalization of the data into 3D representations of the pottery vessels. The 3D models can be created from:

- 2D drawings from publications
- Complete vessels



Figures 1 and 2: Drawing and photograph of pottery vessels

The majority of the 3D models are created through the editing of vessel profiles in 3D software (e.g. Autodesk 3ds Max v9). However, descriptions of the vessel's production process, exterior and interior treatments are also taken into account. This information is used to give additional information for a better understanding of the 3D representations. In conclusion, it deals with the capturing of published images of the vessel into a 3D model and the application of additional information to describe this model.

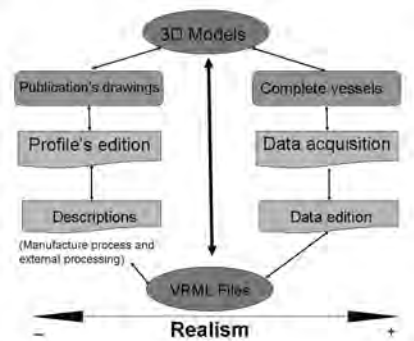

Figure 3: Methodology diagram

When a fairly complete vessel exists a 3D laser scanner can be used (one of the most common technologies used to acquire 3D information).

A common usage of a 3D scanner is the achievement of digital replicas of ancient sculptures. This technology is most adequate to obtain, for example, a 3D model of a statue (Bernardini *et al.* 2002; Fontana *et al.* 2002; Levoy *et al.* 2000; Pollefeys *et al.* 2001; Stumpfel *et al.* 2003). For our purposes we have obtained digital models of pottery vessels. The scanner used was a Konica Minolta VI 900, which produces a triangular mesh of the scanned object. The process phases of the scanner can be summarized as follows:

- Capture alignment. All the captures of the scanned object occupy the same surface, so they are aligned in homogeneous spatial coordinates.
- Fusion of the scanned surfaces assembles a complete model of polygonal mesh.
- Mesh simplification to reduce the complexity of the model, and to produce different levels of detail and representations with different resolutions.

The scanning process is simple and fast, and produces an accurate 3D model of the object with different captures. In some cases two different scanner models have been used, depending on the size of the object (Razdan *et alii* 2001). In this case only one scanner has been used, since it is possible to modify the distance of the scanner from the object, and it is also possible to change the target of the scanner depending on the object's size. The software used for the first data capture has been the Polygon Editing Tool (PET).



Figures 4 and 5: Acquisition system with the Konica Minolta scanner VI-900

2.2. Conversion of the data into models

The polygonal mesh obtained can be exported in different formats for its later treatment (Wavefront OBJ, VRML, STL, IGES ASCII, DXF, and Maya ASCII). For our purposes the polygonal mesh has been exported in VRML or DXF, formats compatible with the software Autodesk 3ds Max v9. Once the model has been imported in this software, different views of the objects can be attained (top view, front view, perspective view...) and different types of visualization (wire frame, with texture...).

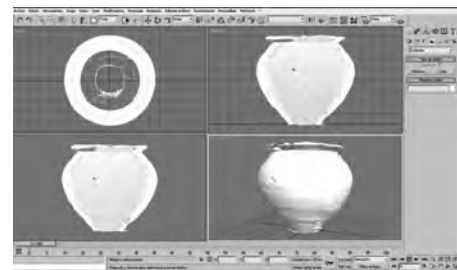

Figure 6: Import of the 3D models into Autodesk 3ds Max v9 software

Once the profile is edited, it is possible to determine the capacity of the complete vessel, a measurement that corresponds geometrically to the internal volume of the vessel's form. One of the methods used to find the capacity is through the revolution of the internal profile (Louise and Dumbar 1995). In this case it has been applied to the drawing of the sections with the program 3D Studio Max, which incorporates the measurement of the volume as a utility.

The capacity of a vessel must be estimated taking into account the morphology, and bearing in mind that it must not be full to the rim. Therefore, a maximum capacity of the vessel must be calculated, which in reality was not always used.

With some forms it is possible to calculate the capacity of the vessel and find the external volume (useful in estimating the number of vessels that can fit in storage area or recipient). The volume of the material which is used to construct the vessel can be obtained by subtracting the internal volume from the external volume. This gives the relation between the volume and the estimated weight of the vessel (the density). The density can be used for the study of technological aspects of the ceramic materials. (Karasik and Smilanski, 2006).

The calculation of the volume can be inexact principally due to the inaccuracy of the drawing of the profile, especially when it is drawn by hand. In this case the problem is solved with the use of the three-dimensional scanner to draw the complete vessels (Sablantig and Menard 1996; Leymarie *et al.* 2001; Razdan *et al.* 2001). There also exist problems with original deformations of the vessels, in which case there should be more than one estimation of profile of the vessel to try to find the volume. These distortions usually appear in non-rotary produced vessels. In rotary manufactured vessels the materials usually do not present the above mentioned deformations. When vessels are made by wheel or mould there exists a greater uniformity in the manufacturing process.

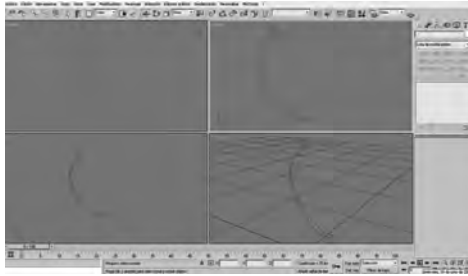

Figure 7: Profile of the vessel



Figure 8: Calculation of the capacity and the volume of the vessel

Although image acquisition software fuses the different views extracted by the scanner, it is necessary to review the polygonal mesh, in case of imperfections in the surface of the mesh that are necessary to correct.

These imperfections may be reduced by automated error correction software of the modeller which generated the mesh. But, there exists no homogeneous format or format converter which can translate the image file format for use in diverse programs. Thus, the polygonal meshes must be converted to other file formats by auxiliary applications different from the one that generated the original file format. This type of conversion process is slightly inefficient, and in extreme cases it must be carried out "point to point" which result in slightly distorted file data.

2.3 Information transfer

The visualization of these 3D models will be carried out using standard formats, which allow their visualization by any user in the Internet. Some standard formats are being investigated to test which of them are more appropriate for the visualization of 3D models.

In this sense, the formats that are the most developed are related to Virtual Reality. These systems develop 3D scenarios of entire or partial immersion of the spectator with the shaped objects. The computer, according to the position and control of the user, uses a database of the virtual environment, and calculates the appropriate visual presentation to present to the user.

The system must be capable of supervising all the actions undertaken by the user; for example, the change of perspective when the user requests such changes. Therefore, the user could receive a feedback that imitates the average responses before the actions are carried out.

The VRML (Virtual Reality Modeling Language) programming language which recreates virtual environments was developed with the purpose of allowing three dimensions image navigation

over the web and has become an official standard of these types of applications.

3. IMPLEMENT OF BOTH METHODOLOGIES

The starting point determines the methodology used for the achievement of 3D models. At this point it is necessary to specify that both methodologies have advantages and disadvantages that can be specified in the following points:

1. 3D acquisition methodology. The use of 3D scanner enormously improves the capture of the vessel's morphology, since it is a system that captures the information without need of surface contact. This system allows capturing of an object's morphology and colour, the resulting image is quite accurate when compare to the original object. In the case of incomplete vessels it is possible to obtain the entire image from a given section.

Nevertheless it is necessary to clarify that the obtained mesh has a high resolution making the digital model difficult to manipulate. In this sense it is necessary to mention the existence of works aimed at the treatment of polygonal meshes of high resolution (Callieri *et alii*. 2008; Borgo, Cignoni, Scopigno, 2001).

Another disadvantage of this system is that the obtained image and texture depend on the light with which the information is acquired. Also it is necessary to point out there are no standards as of yet in these type of acquisition system. Thus, there is no regularization of the 3D acquisition methodology.

2. Creation of 3D models from drawings of complete vessels. The obtaining of 3D models through the edition of the profile in Autodesk 3ds Max v9 is a quick and effective way to obtain 3D models of pottery vessels, allowing volumetric and capacity calculations. These 3D models contribute to a new way of visualization that allows the user to interact with the model choosing several views and parts of the object. This constitutes a more precise and interactive form of visual knowledge of the vessel.

The development of 3D models in three-dimensional edition softwares has been used by several researches (Prieto, Irujo 2005; Moitinho, 2007), obtaining quite real 3D models.

Nevertheless, the 3D models produced are not completely realistic, different levels of realism can be obtained using descriptions of the piece and applying textures to the polygonal mesh with an appropriate library of materials.



Figure 9: Ideal and realistic 3D representations

4. CONCLUSIONS AND FUTURES WORKS

This article has described the methodology used for the achievement of the 3D models that integrate the reference collection of the CATA project. This collection can be consulted by professional archaeologist and by everybody interested in archaeological pottery.

Basically, it is necessary to emphasize two principal data sources will be incorporated into the CATA database: two-dimensional drawings of pottery vessels or complete vessels. As expounded, both methodologies have advantages and disadvantages that facilitate or add difficulties to the process of development of 3D models.

It is also necessary to consider some factors in the development of the 3D models of archaeological pottery:

- Acquisition data system
- 3D mesh edition
- Acquisition and exportation of textures
- Export to VRML format without quality loss
- Purpose for which the models are elaborated

The 3D models allow not only a new form of visualization, but also an exhaustive analysis about manufacturing processes.

The 3D models are going to be integrated into an accessible database in the Internet. The above mentioned models not only allow a virtual manipulation of the vessels, but can be analyzed manufacture process.

5. REFERENCES

Bernardini, F.; Rushmeier, H.E.; Martin, I.; Mittleman, J.; Taubin, G., 2002. Building a digital model of Michelangelo's Florentine Pieta, *IEEE Comp. Graphics & Applications* 22, 1, pp. 59-67, Jan/Feb, 2002.

Borgo, R., Cignoni, P., Scopigno, R., 2001. An Easy to Use Visualization System for Huge Cultural Heritage Meshes, *Proc. Virtual Reality, Archeology, and Cultural Heritage (VAST) 2001*, D. Arnold, A. Chalmers, and D. Fellner, eds., ACM Press, 2001, pp. 121-130.

Callieri, M., Ponchio, F., Cignoni, P., Scopigno, R., 2008. Virtual Inspector: A Flexible Visualizer for Dense 3D Scanned Models, *IEEE Computer Graphics and Applications*, vol. 28, no. 1, pp. 44-54, Jan/Feb, 2008.

Fontana, R.; Greco, M.; Materazzi, M.; Pampaloni, E.; Pezzati, L.; Rocchini, C.; Scopigno, R., 2002. Three-dimensional modelling of statues: The Minerva of Arezzo, *Journal of Cultural Heritage* 3, 4, pp. 325-331.

Karasik, A.; Smilanski, U., 2006. Computation of the Capacity of Pottery Vessels Based on Drawn Profiles, *Excavations at Tel Beth Shean 1989-1996*, vol. I, Mazar A. (ed.), Jerusalem (Israel).

Karasik, A., Smilanski, U., 2008. 3D scanning technology as a Standard archaeological tool for pottery analysis: practice and theory. *Journal of Archaeological Science* 35 (2008) pp. 1148-1168.

Laudon, K.C.; Laudon, J.P., 1996. *Management Information Systems, Organization and Technology* (B.4) Prentice-Hall, Inc., New Jersey (United States).

Levoy, M.; Pulli, K.; Curless, B.; Rusinkiewicz, S.; Koller, D. Pereira, L.; Ginzton, M.; Anderson, S.; Davis, J.; Ginsberg, J.; Shade, J.; Fulk, D., 2000. The digital Michelangelo Project: 3D scanning of large statues, *SIGGRAPH 2000, Computer Graphics Proceeding*, Annual Conference Series, Addison Wesley, pp. 131-144.

Leymarie, F.F.; Cooper, D.B.; Sharp Joukowsky, M.; Kimia, B.B.; Laidlaw, D.H.; Mumford, D.; Vote, E.L., 2000. The SHAPE Lab.- New Technology and Software for Archaeologist, *Computing Archaeology for Understanding the Past CAA2000. Computer Applications and Quantitative Methods in Archaeology (BAR Int. Ser. 931)*, pp. 79-89. Stancic, Z. y Veljanovski, T. (eds.), Oxford.

Louise, M.S.; Dunbar, P.B., 1995. Accurately Estimation Vessel Volume from Profile Illustrations, *American Antiquity* 60/2, pp. 319-334.

Mitinho, V., 2007. The Roman Villa in Rabaçal Virtual Museum, *Proc. The 8th International Symposium on Virtual Reality, Archaeology and Cultural Heritage (VAST) 2007*. D. Arnold, F. Niccolucci, A. Chalmers, eds., pp. 74-78.

Pollefeys, M.; Gool, L.J.V.; Vergauwen, M.; Verbiest, F.; Tops, J., 2001. Image-based 3D acquisition of archeological heritage and applications, *VAST 2001 Conference Proc.* Arnold, D.; Chalmers, A. y Fellner, D. (eds.), ACM Siggraph, pp. 255-261.

Prieto, M.P.; Irujo, D.J., 2005. Aplicaciones del 3D en cerámica prehistórica de contextos arqueológicos gallegos: Un estudio sobre percepción visual. *Arqueoweb: Revista sobre Arqueología en Internet*. 1139-9201, Vol. 7, Nº. 2.

Razdan, A.; Liu, D.; Bae, M.; Zhu, M.; Farin, G.; Simon, A.; Henderson, M., 2001. Using geometric modeling for archiving and searching 3D archaeological vessels, *Proc. Conf. on Imaging Science, Systems and Technology*. Las Vegas (United States).

Sablatnig, R.; Menard, C., 1996. Computer-based Acquisition of Archaeological Finds: the First Step towards Automatic Classification, *3rd International Symposium on Computing and Archaeology*.

Stumpf, J.; Tchou, C.; Hawkins, T.; Debevec, P.; Cohen, J.; Jones, A.; Emerson, B., 2003. Assembling the sculptures of the Parthenon, *VAST 2003* D. Arnold; A.C. Niccolucci F. (eds.), Eurographics, pp. 41-50.

RECORDING AND MANAGING THE ARCHAEOLOGICAL HERITAGE IN THE BRUSSELS CAPITAL REGION, BELGIUM - A CHALLENGE FOR THE FUTURE

A. Degraeve ^a

^a Direction of Monuments and Sites, Department of Archaeology, Ministry of the Brussels Capital Region, rue du Progrès 80, bte 1, 1035 Brussels, Belgium – adegraeve@mrbc.irisnet.be

KEY WORDS: archaeological database, archaeological heritage, depot management, stratigraphy, restoration, archaeological objects

ABSTRACT:

In 2000 a comprehensive database has been initiated containing all information regarding the archaeological excavations in the Brussels Capital Region, Belgium. The database is structured in such a way that first the data concerning the archaeological site must be entered, the period of excavation and the staff involved. The next stage concerns an elaborate description of each stratigraphic unit excavated. Once the site information and the stratigraphy levels have been introduced, one can start the description of the archaeological objects discovered during excavation. The Object Form contains all general information regarding the object. Various sub-forms are linked to it, arranged following the kind of material the object is made of and containing a detailed description of the object. Each sub-form is equally linked to a restoration form containing all technical interventions on the object. Unprocessed Objects, Depot and Loan Forms describe respectively the condition of the objects upon entry in the storage room, their exact location and condition within the depot and the information regarding objects sent for analysis and exhibits. Various queries, reports and lists, accessible via predefined buttons on the entrance menu of the database, allow the editing of archaeological reports and likewise constitute at any moment a summary of the whereabouts of the archaeological objects and samples. This database is therefore an extremely useful tool allowing both scientific research and depot management.

1. INTRODUCTION

The inventory of the archaeological excavations in the Brussels Capital Region, Belgium, and the management of its archaeological depot are realized with the help of a newly created database. It is based on the registration of the various discoveries in their archaeological contexts, and this for every site excavated within the Region. This implies a continuously carefully thought out structure for the different levels of information regarding the excavation (site, stratigraphic units, description of objects), the treatment of the objects (e.g. various restoration procedures) and the management of the storage. Therefore, the input of archaeological data has to be clear and precise, as a correct registration forms the base of an accurate conservation.

Since 1989, archaeological heritage is a regional competence in the federal state of Belgium. Each region (the Flemish, the Walloon and the Brussels Capital Region) has therefore its own specific archaeological decrees and working methods (Draye, Matthys & Demeter, 2005). The three regions create various inventories of their archaeological sites: the Central Archaeological Inventory in Flanders (CAI-I, 2004), the Planarch project in Wallony (Le Projet Planarch, 2002) and the Atlases of the Archaeological Sites in the Brussels Region (each commune of the Region has its own atlas: e.g. Guillaume & Meganck, 2008). However, these inventories are mainly used in the context of site management and less for “moveable” archaeological heritage. Moreover, the various world-wide existing databases related to archaeological objects are mostly concerned with museum management esp. identification of objects in case of theft, and not with archaeological research or the archaeological depot management. A large amount of information concerning the archaeological site, the layers, the objects and their restoration and analyses can thus not be introduced.

A first version of a specific archaeological research database was therefore created in the year 2000, inspired by the results of a project initiated by the Flemish Community on standards for registration of archaeological objects in a museum context (Driesen, Wesemael & ARON bvba, 2001). It was successfully tested on the then excavated archaeological sites, Moresco at the Sablon and Treurenberg behind the Sts.-Michael-and-Gudula-cathedral situated on the remnants of the 13th century first city wall. Today, this database has evolved into a research instrument combined with an archaeological storage management tool.

The database has been developed in Microsoft Office Access 2000. It is housed on the central server of the Direction of Monuments and Sites of the Ministry of the Brussels Capital Region and consists of a front-end holding the interface and a back-end holding the actual data, thus allowing a multi-user environment. Its structure consists of various tables, linked by relationships one-to-one or one-to-many, and based on the introduction of the so-called unique number, attributed to each object. Hyperlinks give access to images identifying the objects. These images are stored on a second central “digital image”-server, independent of the general server. In order to avoid any accidental deleting, they have a fixed place and can only be moved by special request to the server manager.

In order to reduce as much as possible human error upon entry of the data, most fields consists of scrollable lists or clickable squares and the unique numbers appear automatically in related subfields. Continuous feedback and weekly evaluations create a permanent evolution of the database potential: e.g. activation of new fields and queries, completing of the scrollable lists, etc. On a regular basis, controls are effectuated in order to eliminate possible errors.

2. STRUCTURE OF THE DATABASE

2.1 The archaeological site

The data-input requires a specific order of entry, starting with the Site Form. In the Brussels Capital Region, each archaeological site receives a code composed of 2 letters, indicating the commune concerned, and a number from 1 to n per commune. This code is attributed to each site upon entry of the dossier at the Archaeological Department of the Direction of Monuments and Sites. E.g. BR59= Commune of Brussels, Treurenberg street nrs. 6-14. The Site Form contains a range of fields identifying the archaeological site with its code, address, cadastral references, Lambert coordinates and the nearest altimetry point of the National Geographic Institute.

The names of the proprietor of the land or building and of the building contractor are also introduced. They are linked to a sub-file containing all useful information like address, contact person etc. A third sub-file is the Intervention Form, containing the dates of the archaeological excavation and the names of the persons that participated: archaeologists, technicians, workmen, voluntaries and trainees.

After the Site Form, the input continues with the Stratigraphic Units Form, containing all information about the stratigraphic units encountered during excavation. Each stratigraphic unit is composed of the Site Code followed by a number from 1 to n (e.g. BR59/023= Stratigraphic unit 23 of site BR59). At any moment one can have immediate access to the data concerning the site by clicking a Site Form button located on the Stratigraphic Units Form. The database will direct you automatically towards the exact site. The Stratigraphic Units Form contains, next to the Stratigraphic Unit Code, its location on the site, the type of layer (e.g. a soil, the filling of a pit, etc.), its texture (sand, silt, clay, etc.), the stratigraphic links. In the case of a constructed Stratigraphic Unit, the form permits a description containing the sort of construction (wall, foundation, vault, staircase, etc.), the elements of construction (bricks, quarry-stones, etc.), their size and the way they are combined (in rows, edgewise, etc.), and information concerning the used mortar, its colour and the jointing. A first general description of the various categories of discovered objects (e.g. ceramics, bone material, metal objects, etc.) and a field indicating the sampling of the layer are also added. A button gives access to the detailed report concerning the various analyses of the stratigraphic layers (archaeopedological, physical, chemical, etc.). Finally a field contains the identification of the drawings and pictures containing the stratigraphic unit considered and a hyperlink gives access to this picture or drawing.

The tombs are registered starting from the Stratigraphic Layer Form. The Tomb Form copies the categories of the form used in the field. The various data to be filled in are the skeleton number and the associated stratigraphic unit, its localisation, the person that excavated the tomb, the pictures and drawings, the type of burial (primary or secondary), the general position of the body, the general preservation of the skeleton and of its bony tissue, and the orientation of the body. Next are introduced the position of the various body parts (head, torso, arms, hands, legs and feet) followed by the information concerning the preservation of other body elements like skin and finger- and toenails, the conservation techniques that were eventually applied, and the possible objects found around the body, e.g. nails from the coffin, ceramics, personal items, etc. A

hyperlink gives access to an image of the tomb and a button shows the detailed results of the palaeoanthropological analysis of the skeleton.

One of the future goals is to introduce the results of dating procedures and of floral and faunal research by way of hyperlinks to .pdf-files: archaeobotany, pollen, phytoliths, dendrochronology, animal bones, shells, etc.

2.2 The Objects

Only when the Site Form and all the Stratigraphic Unit Forms are filled in, one can start the recording of the archaeological objects in the Object Form. Each object receives first a unique number, composed of the site code, followed by the stratigraphic unit number, followed by a number from 1 to n ; e.g. BR97/501/01755 = object nr. 1755 of site BR97 found in layer 501.

After the introduction of the object number follow the category of the object (ceramics, metal, etc.), its state and if the object can be used for exhibition, its dimensions and the localisation of drawings and pictures with a hyperlink to visualise them. Finally one can introduce the dating of the object, its publication, the scientific literature consulted and eventual remarks.

Starting from the general Object Form, the sub-forms with the information specific for each kind of material are filled in. Access to the sub-forms is gained by clicking the appropriate button on the Object Form: ceramics, metal objects (with coins considered as a special case), glass objects, tobacco-pipes and pipe-earthen objects. Each sub-form has the possibility to add hyperlinks visualising pictures of the object. Actually research is on-going in order to create the sub-forms concerning the building materials (bricks, roof tiles, stucco, floor and wall tiles, etc.), and objects in organic material (e.g. wood, ivory).

Each Sub-form is linked with a specific Restoration Form describing the interventions previous to the actual restoration, the cleaning of the object, the gluing, the consolidation, and the conservation measures taken or to be integrated in case of exhibition. Hyperlinks give access to pictures illustrating the treatment of the restored object (before, during and after treatment).

The Ceramics Sub-form contains information concerning the function and components of the object, the fabric (clay, temper, firing technique), the presence of glazing, and its provenance. Numerous fields deal with the description of the decoration present on the object. In the near future the decoration fields will be adapted: many forms of decoration, especially in the case of post-medieval ceramics, need extensive descriptions.

The Metal Objects Sub-form describes the multitude of different objects found during excavations from small needles to the large iron bar. The kind of metal and the technique used to produce the object are also cited. The Coin Form has been separated from the Metal Objects Sub-form as it includes very specific fields concerning the type of coin, the material it is made of, its condition and weight, the period of minting and the sovereign concerned, and a description of decoration and legend on both sides. The Glass Form mentions the function of the glass object, the technique used, the decoration and the original colour. The Tobacco-Pipe Form describes the various parts of the tobacco-pipe with their measures, the decoration, traces of

utilisation and the identification of the factory. The Pipe-earthen objects Form includes the description of some peculiar objects like small painted round plates with various religious and non-religious subjects and small statues of the "Child Jesus". These objects were used to decorate Eastern breads and are frequently found in excavations.

2.3 Depot Management

The organisation of the depot starts with the boxes coming from the excavations into the transit room. The contents of each box are inventoried in the Unprocessed Objects Form: the kind of archaeological objects, the size of the bags and eventual remarks on the general condition of the object(s). Next, the contents will be carefully sorted, washed, treated, restored if necessary and finally inventoried. Then they are stored and organized per site, per kind of material and per stratigraphic unit.

The Depot Form contains the location of the boxes during the various treatments (storage room, cleaning room, restoration laboratory or research unit), a macro-description of their contents (e.g. ceramics, glass, etc.) and a micro-description comparable to the Unprocessed Objects Form (size and content of the bags, stratigraphic layer). The various stages of treatment of the bags in the boxes can also be indicated: washed, marked, grouped by material, gluing, inventoried. Preformatted queries simplify the management of the objects and the archaeologists' research questions e.g. in which box and in which bag one can find a certain material of a given stratigraphic layer; or where can one find the archaeological objects of a given layer; etc.

The Loan Form contains the number of the object, its date of departure and of return, the location/institution it went to with address and contact person, the reason (analysis, exhibit, etc.), and the necessary insurance information. We are actually working on an automated official loan document consisting of simple queries enabling the curator to export the necessary loan information into a preformatted printable document.

2.4 Archaeological Research and Depot Management

The entrance menu of the database contains a range of buttons divided in three sections: data-input, research and depot management.

The data-input section gives direct access to the various forms described above. The research sections contains buttons activating queries like e.g. a list of all ceramic objects from a particular site, the objects found in a certain layer, a list of all stratigraphic units for one site. New queries can easily be created whenever an archaeologist needs certain information to study an excavation or prepare the publication.

The buttons in the depot management section give immediate access to e.g. a list of all archaeological objects moved from the depot for analysis, exhibits, etc. with their date of departure and their actual localisation.

3. CONCLUSION

The computerised inventory presented here has a double advantage for the archaeologist. First, he can conduct and publish the complete scientific study of an excavated site. Secondly, the input of data into one and single database for the

whole of the archaeological excavations of one Region facilitates transversal analysis. The curator of the depot on his side can track each object placed under his responsibility. With the help of the scientific and technical information gathered during the numerous treatments of the archaeological objects, the depot manager obtains an optimal conservation of the archaeological heritage and guarantees at the same time access for future generations of researchers.

4. REFERENCES

- CAI-I, 2004. De opbouw van een archeologisch beleidsinstrument (IAP-Rapporten 14), Brussel.
- Draye, A.M., Matthys, A. & Demeter S., 2005. The Protection of Archaeological Heritage in Belgium. La protection du patrimoine archéologique en Belgique. In: *The Protection of Archaeological Heritage. Annual onference ICLAFI, Brussels (Belgium), 23-26 November 2005*, Belgian National Committee of Icomos, pp. 21-37.
- Driesen, P., Wesemael, E. & ARON bvba, 2001. *Standaarden voor de registratie van archeologische objecten in een museale context* (Registratie en automatisering van museale collecties 6), Ministerie van de Vlaamse Gemeenschap, Afdeling Beeldende Kunst en Musea.
- Guillaume, A. & Meganck, M., 2008. *Atlas du Sous-sol archéologique de la Région de Bruxelles. 18. Evere, Bruxelles Le Projet Planarch. Archéologie et Aménagement du Territoire*, 2002. Les Cahiers de l'Urbanisme Hors Série, Ministère de la Région Wallonne, Liège.

ARCHITECTURAL INFORMATION MODELLING FOR VIRTUAL HERITAGE APPLICATION

P. Pauwels^a, R. Verstraeten^{a,b}, R. De Meyer^a, J. Van Campenhout^b

^a Dept. of Architecture and Urban Planning, Faculty of Engineering, Ghent University, J. Plateaustraat 22, Ghent, Belgium - (pipauwel.pauwels, ruben.verstraeten, ronald.demeyer)@ugent.be

^b Dept. of Electronics and Urban Planning, Faculty of Engineering, Ghent University, J. Plateaustraat 22, Ghent, Belgium - (ruben.verstraeten, jan.vancampenhout)@ugent.be

KEY WORDS: Virtual Heritage, Building Information Modelling (BIM), Architectural Information Modelling (AIM), Industry Foundation Classes (IFC), historical research

ABSTRACT:

In today's AEC industry (Architecture, Engineering and Construction industry), there has been a vast evolution in the usage of information and communication technology (ICT) for describing and managing construction projects. During the past years this led to the elaboration of the technique Building Information Modelling or BIM for describing buildings and building information according to their different composing elements. One of the major advantages in this BIM approach is the possibility to use this building information for calculation, simulation and analysis in related, more dedicated ICT applications. Starting from the building information model, these applications are accessible through an interoperability language, namely the Industry Foundation Classes (IFC), elaborated by the International Alliance for Interoperability or IAI. This paper proposes the development of an approach similar to BIM, namely Architectural Information Modelling (AIM), which describes more theoretical and historical building knowledge instead of the explicit and component-based descriptions inside BIM. It illustrates several possible advantages of this AIM approach for application in building documentation for virtual heritage, combined with possible historical analysis tools. It also makes a short comparison of this technique with procedural methods, a similar technique that is gaining much interest during the past few years in the domain of virtual heritage. Finally, this paper proposes future research ambitions and some conclusions of this first, conceptual research about an architectural information modelling approach.

1. INTRODUCTION

The digital archiving process, the management and the providing of accessibility for virtual heritage information has been actively researched over the past two decades. An exemplary organisation that performs active and thorough research on this domain and the possible techniques for this purpose is the World Heritage Centre (WHC) of the United Nations Educational, Scientific and Cultural Organisation (UNESCO). In order to make the world heritage virtually accessible for historical research, numerous disappeared monuments have been reconstructed and digitised under their impulse (Quintero, 2003).

For the digitalisation of our cultural heritage, very diverse ICT techniques can be used, i.e. three-dimensional modelling techniques (Quintero and Jansen, 2002; Müller et al., 2005), digital drawings, maps and plans, reconstruction techniques based on photo material (Van Gool et al. 2002; 2004), procedural modelling, etc.

This paper focuses on one particular ICT technique that can be used in the digitalisation and archiving process, namely the three-dimensional information modelling technique. A possible workflow, corresponding advantages, and new perspectives that can be offered for virtual heritage by this technique, will be illustrated in this paper. This will be based on earlier performed, historical research about the former Casino in Ghent (Boydens, 1986). This building was designed and built by architect Louis Roelandt in 1836 and was demolished in 1945.

A building information model has been constructed in Autodesk Revit Architecture 2008 (Figure 1). This BIM modelling

technique and its advantages are shortly commented and illustrated.



Figure 1: Exterior view of the *Building Information Model* of the Casino in Ghent.

1.1 Building Information Modelling

The different objects in the BIM model in Figure 1 (doors, walls, window, spaces, etc.) are modelled and stored in an object-oriented structure, using several proprietary file formats. However, these file formats lack the required interoperability for further simulation, evaluation and analysis.

Through a newly created file format, namely the IFC standard or Industry Foundation Classes, this issue of interoperability is countered. This IFC file format is created as a highly interoperable information structure, that tries to guarantee that the information in this IFC format can be browsed and queried on an object-oriented and semantically rich basis.

By fulfilling this purpose, software creators do not need to develop their applications in correspondence with specific file formats or dataflow structures of existing applications. Instead they only have to rely on this internationally standardised, ontological format, that describes building information of different projects, monuments and buildings in a similar grammar and syntax (Penttilä, 2007; Penttilä et al., 2007).

1.2 Advantages

Concerning information management issues, this characteristic purpose and work method of BIM and IFC is considered to be a solid and useable improvement in building industry. One information model in a standard interoperable data format can be constructed centrally in any small- or large-scale building project, from which every actor in this project can extract the required information. It seems that in today's AEC industry this is particularly used in the construction phase of architectural design and building projects (Penttilä, 2007).

Following the BIM information modelling techniques and the creation of the IFC data standard, numerous ICT applications are being developed, which are capable to read the information of this model via IFC and use it directly to perform automatic analyses, simulations and calculations. It is possible for instance to automatically perform a cost calculation or to compose a time planning proposition for a building project, or for example to perform different heat transfer simulations and building permit analyses.

A more theoretical and historical kind of information could be used as well in this information modelling technique. By giving this small, but very meaningful twist to the actual contents of the present information modelling approach, a whole new range of applications can emerge. An important set of applications can be situated in the preliminary design phase of an architectural project, but also in the work methods and dataflow in the digitalisation and documentation process for virtual heritage projects.

This hypothesis is illustrated and documented in the remainder of this paper, through the architectural information modelling approach. This technique is mainly based on the existing BIM approach, but is using different, more theoretical and historical information instead of the construction-minded, components-based building information of the present BIM approach. The historical context of the Casino in Ghent (Figure 1) is used as an illustrating example.

2. ARCHITECTURAL INFORMATION MODELLING

2.1 Usability in virtual heritage applications

Based on the scarcely found information about a certain architectural building or monument, a three-dimensional information model can be constructed. In this model the different kinds of information, ranging from explicit to more implicit historical and theoretical information, can be appended to the different elements of this model. This information can be added in the form of building features, similar to the BIM work methods (Eastman et al., 2008).

In a cultural heritage application, this could lead for instance to the following workflow. A reconstruction is performed for a specific cultural heritage building or monument of which only a

few elements of information are found through historical research. For each recovered building element, information is added to the central architectural information model, continuously expanding the knowledge of this specific cultural heritage building and thus expanding the global virtual heritage knowledge.

On one hand this added information can be concrete geometrical parameters, material characteristics or references to explicit research material, like photographs or scanned documents. On the other hand also more abstract or implicit information can be modelled, such as references to similar projects or projects of significant historical influence, known typological information, environmental constraints or regionally applied regulations that have been followed and are critical in the understanding of that particular project.

2.2 Methodology

As a starting point for a conceptual test-case, it was stated that the modelling technique can be used for describing the building structure of the Casino, not through the composing building elements (doors, walls, windows, etc.), but through the actual spatial structure, a network of spaces. This abstract spatial structure could then form the core structure of the actual architectural information model, to which further architectural information is appended as different kinds of features. These features range from typological information to spatial relations and historical references for instance, as well as the actual geometric building information.

The spatial structure of the Casino for example ('central hall', 'far wing north', ...) can then be modelled to its three-dimensional overall shape in an architectural information model (Figure 2).

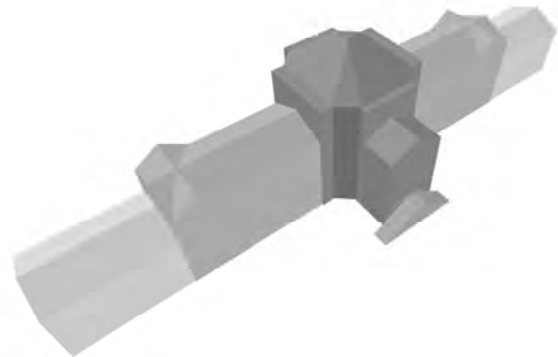

Figure 2: Architectural information model, showing the overall spatial structure of the Casino in Ghent.

In this three-dimensional architectural information model, every building block is divided into several underlying abstract spaces, as shown in

Figure 3. The building block 'central hall' for example is divided into two building levels, each containing one space, namely a 'storeroom' and a 'reception hall', depending on the information that is found in the performed historical research.

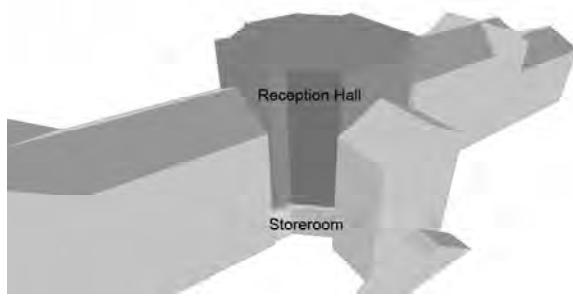

Figure 3: Each building block in the architectural information model is divided in different spaces, like for instance 'storeroom' and 'reception hall'.

Starting from this schematic spatial information model, containing more abstract and spatial than precise and detailed building information as a core structure, a high amount of information is added during different stages of historical research. Each part of information is linked to the corresponding part of the spatial structure in the AIM model. This information can be very diverse, exactly because there is only an abstract spatial model lying at the basis of the model, instead of the actual building components (i.e. complete walls, windows, columns...), that prove to be too complex and detailed to start modelling from the research start (Penttilä, 2007).

The added information covers the actual geometric descriptions of the spatial structure. To each building block or space different annotations are added about the actual building components that are known to limit and form the considered part of the spatial structure. Figure 4 shows the different building components that constitute the 'central hall' of the Casino. Each of these geometric building components would then contain further detailed information, as is already happening inside the BIM approach.

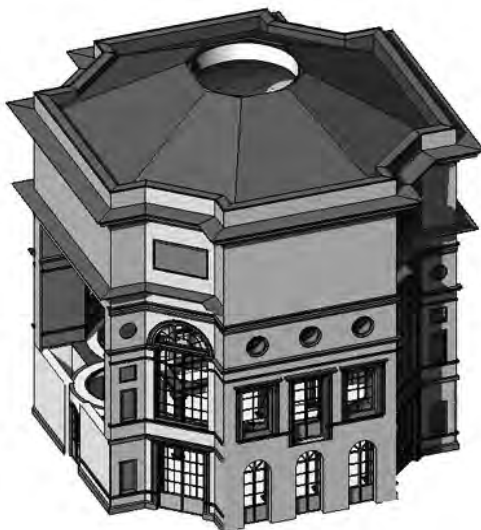

Figure 4: Geometric building components that are annotated to the 'central hall' of the Casino in Ghent.

In addition, more abstract theoretical and historical knowledge is also added to this spatial structure, such as references to

historical plans or other documentation that was found in the historical research project, or possible relations between spaces and typological annotations. It is also possible to add certain information about a time range wherein the element that's being considered, existed, or implicitly present environmental or architectural parameters and constraints that shaped the building during different design phases.

The resulting information model contains for almost every part of the building its documentation and information, directly bound and visualised to the actual element it belongs to (a space, an abstract typology, a wall or floor, an historical reference, etc.). In this way, the AIM modelling technique probably improves existing methods for documentation and digital archiving by making architectural, historical and theoretical research more efficient.

The amphitheatre at the backside of the Casino (Figure 1) for instance is probably shaped by a former hill slope with a windmill on top. In case an architectural information model for this windmill existed, it could be referenced in the AIM model for the Casino. In that way, the user who is actually interested in the Casino information, could also have a preview of the information about the windmill, for example the time period it was standing there and information about the way it was built and the way it influenced the conception of the amphitheatre and the Casino.

The information about the windmill would then probably be coming from earlier research projects. By archiving this information linked to the specific correlated elements in a standardised architectural information model, it becomes possible for a user to quickly and intuitively review the information connected to a structure that is somehow related to the building he is actually interested in at that moment, without having to go through a thorough historical research project in order to find all related historical documentation and original plan material of that related building.

2.3 Advantages and possibilities

Besides the advantages which this architectural information modelling approach could give for the process of digitising, documenting and archiving of theoretical and historical building information, the approach could also generate several new perspectives in the creation of applications that can (re)process this information.

When, for example, the more explicit, geometric parameters and the use of different object types (window types, door types, column types, ...) are considered, it is possible to develop applications that can look for certain similarities and differences between two different buildings in this global virtual heritage.

Considering 'Le Palais de Justice' in Ghent (Figure 5), which was equally designed by architect Louis Roelandt, there are undoubtedly resemblances and similarities to be recognised between this building and the Casino he designed almost at the same time a few blocks further in the city. The five doors for example, which are indicated in Figure 5, are most probably the same as some of the doors he used in the Casino and that can be found at ground level in Figure 1 and Figure 4.



Figure 5: 'Le Palais de Justice' in Ghent, by architect Louis Roelandt in 1836.

By modelling more abstract theoretical and historical information, in addition to the pure geometric information, it is possible to search for similarities between this sort of information as well. If the AIM approach can make it possible to explicit information about how architect Louis Roelandt conceptually designed both the Casino and 'Le Palais de Justice', this information could be (semi-)automatically queried by dedicated applications to find out if there are similarities or remarkable differences in the design methods and decision-making that shaped the two buildings, or maybe if one design obviously influenced the other design, etc.

If these research possibilities are extended towards different architects and different time periods for instance, the AIM approach can probably generate several more advantages, which can hardly be foreseen at this moment, for the use and research of design and theoretical or historical information in the virtual heritage domain.

3. INFORMATION MODELLING OR PROCEDURAL MODELLING

A technique that is quite similar to the AIM approach and that has gained remarkable interest during the past few years in cultural heritage research, is procedural modelling (Parish and Müller, 2001). One of the variants of this procedural modelling technique, namely the procedural modelling approach based on style grammars, shows a great resemblance to the presented architectural information modelling technique. This grammar-based procedural method is already used in several application domains, such as urban modelling (Parish and Müller, 2001) and modelling for virtual heritage application (Müller et al., 2006).

In this grammar-based procedural modelling technique it is made possible to define sets of meaningful parameters and functional rules to three-dimensional models. These are capable of describing different building styles, with which several 'similarly styled' buildings can semi-automatically be generated, to form a complete urban landscape, a possible alternative formalism in a cultural heritage monument (Müller et al., 2006), etc.

The procedural modelling technique is at this time mainly used to facilitate the three-dimensional modelling process of big and complex datasets (i.e. infinite urban landscapes, highly detailed

and complex heritage monuments, etc.). Therefore, the amount of information that is subject of this technique is kept to a minimum.

In (Müller et al., 2006) for instance, a procedural modelling workflow is elaborated for the Mayan Puuc buildings in Xkipché. It shows very effectively how a lot of modelling and alteration work can easily be done in a procedural method by common archaeologists. However, also several encountered problems have been situated in (Müller et al., 2006), of which one is stating that the model is detailed only to a certain level and lacks an amount of precision for the actual documentation purposes needed in virtual heritage (i.e. imprecise door locations, missing GIS data, etc.).

Despite the several resemblances between the architectural information modelling and the procedural modelling approaches, the two techniques are quite different at this specific point. At this time of research for the information modelling approach, the accent namely lays on the actual information of the building itself and less on the resulting visual appearance or the way how archaeologists could create and alter this building model.

This means that much more parameters and information is archived and made accessible in the architectural information modelling approach, not only of a pure geometric or visual kind, but also of more abstract and implicit building knowledge of a theoretical and historical kind. An AIM model for the Puuc buildings in Xkipché would for instance contain more detailed instances of doors and windows than is possible at this moment using procedural methods. Also detailed information such as the materials used in this temple or for instance the actual reasoning of the Mayans in the conception and the building process of the temple in question, could be added for documentation of the actual cultural heritage information.

A more extensive comparison between this procedural modelling technique and the proposed architectural information modelling technique is needed, but exceeds the scope of this paper. Both approaches have their advantages and disadvantages, and probably none of them is the 'perfect' or 'right' approach. If the advantages of both techniques however, could be combined in one integrated approach, archaeologists, as well as building modellers, architects and people from many other scientific domains would benefit.

4. FUTURE WORK

At the time being, the AIM research has been preserved to merely conceptual research activities. As a start, the different aspects that may be needed in an architectural information modelling approach have been shaped to a conceptual completed scheme. In this conceptual shaping process, the different possibilities and advantages which the information modelling technique can generate in combination with dedicated virtual heritage ICT applications, have been identified and denominated.

However, to make this conceptual AIM approach actually work in a virtual heritage environment, two fundamental steps will be taken in further research.

The first step is the definition of an appropriate equivalent of the existing IFC Classes in the BIM approach, for application in

the AIM approach. The IFC classes that are used in the BIM approach, are namely limited to machine-readable, concrete information, i.e. financial costs, material names, construction phases, etc. and don't describe more theoretical and historical information, which is necessary in an architectural information modelling approach.

The second step in future research also applies on this distinction between concrete building information and more abstract, theoretical and historical information. Where the more concrete building information can be rather easily identified and uniquely denominated, the description of more theoretical and historical information is difficult. For instance, while the description of a concrete wall into physical characteristics and exact measuring data is precisely known and therefore easily made machine-readable, a lot of theoretical concepts and historical knowledge stays locked in images and sketches or between the lines of texts for example, and therefore explicitly require human interpretation and intelligence.

When the aim is to unlock this knowledge as well, there will be a certain amount of machine intelligence needed. At the time of writing, several international research projects are performed to improve this machine intelligence. One of these research projects for instance is performed by (Berkhahn and Tilleke, 2008), who use neural networks and topological models to recognise dimensions and common lines out of 2D images and plans. After this recognition process a three-dimensional model can be built in IFC, using the recognized information.

However, this is only one of the possible ways to improve machine intelligence and computer vision for the recognition of information out of images, text, video and other multimedia. Further research has to be done on this subject to evaluate the possibilities in using and possibly further improving these techniques.

5. CONCLUSION

Different kinds of ICT digitalisation techniques and applications can be used for the digitalisation, documentation and archiving of virtual heritage information. In this paper, one of these techniques is highlighted, namely the three-dimensional information modelling technique that is known as Building Information Modelling or BIM in architectural design practice. This technique describes the different composing building elements according to their composition, characteristics and other kinds of information. Using a standard IFC (Industry Foundation Classes) file format, this information can be stored in a highly interoperable structure. This makes it possible for other ICT applications to perform simulations, calculations, etc. based on this information.

The same modelling technique, that has proven its documentation and archiving advantages already in architectural design practice, can possibly be used as well to model more theoretical and historical information which can be useful for virtual heritage application. An alternative information modelling technique is proposed, namely Architectural Information Modelling or AIM for the digitalisation, documentation and archiving of the international cultural heritage.

By using this modelling technique, new ICT applications can emerge, based on the information in the central architectural

information model. Several possible applications and the corresponding advantages of using these applications have been highlighted in this paper. The exact possibilities and advantages of using the proposed architectural information modelling technique for virtual heritage purposes are at this moment however rather unclear and still depend largely on the results of the development of the architectural information modelling technique itself.

In the further development of this architectural information modelling technique, first attention will go to the delineating and structuring of the actual theoretical and historical information in this AIM approach. Since there are no 'Architectural' Foundation Classes available at this time, these classes will be developed during further research. The combination of the AIM techniques with related techniques, such as procedural modelling methods and techniques that try to improve machine-readability of documents and the actual machine intelligence will be researched.

6. ACKNOWLEDGEMENTS

This research was funded by the FWO Fund of Scientific Research Flanders. As an FWO research fellow, the first author would like to thank the FWO for this funding.

7. REFERENCES

- Berkhahn, V., Tilleke, S., 2008. Merging neural networks and topological models to re-engineer construction drawings. *Advances in Engineering Software*, 39(10), pp. 812-820.
- Boydens, H., 1986. *Lodewijk Jozef Roelandt*, Nieuwpoort: Culturele raad.
- Eastman, C., 1999. *Building Product Models: Computer environments supporting design and construction*. CRC Press, Boca Raton, Florida, USA.
- Eastman, C., Teicholz, P., Sacks, R., Liston, K., 2008. *BIM Handbook: A Guide to Building Information Modeling for Owners, Managers, Designers, Engineers and Contractors*. John Wiley & Sons.
- Müller, P., Vereenooghe, T., Vergauwen, M., Van Gool, L., Waelkens, M., 2005. Photo-realistic and detailed 3D modeling: the Antonine nymphaeum at Sagalassos (Turkey). In: *Proceedings of the 32nd Conference on Computer Applications and Quantitative Methods to Archaeology - CAA 2004*, Prato, Italy.
- Müller, P., Vereenooghe, T., Wonka, P., Paap, I., Van Gool, L., 2006. Procedural 3D Reconstruction of Puuc Buildings in Xk'ipché. In: *Proceedings of the 7th international symposium on virtual reality, archaeology and intelligent cultural heritage - VAST2006*, Nicosia, Cyprus, pp. 139-146.
- Parish, Y., Müller, P., 2001. Procedural Modeling of Cities. In: *Proceedings of the 28th annual conference on Computer graphics and interactive techniques - SIGGRAPH 2001*, ACM Press, Los Angeles, California, USA, pp. 301-308.
- Penttilä, H., 2007. Early Architectural Design and BIM, In: *Proceedings of the 12th International Conference on Computer*

Aided Architectural Design Futures, Sydney, Australia, pp. 291-302.

Penttilä, H., Rajala, M., Freese, S., 2007. Building Information Modelling of Modern Historic Buildings - Case study of HUT/Architectural Department by Alvar Aalto. In: *Proceedings of the 25th eCAADe Conference*, Frankfurt/Wiesbaden, Germany, pp. 607-613.

Quintero, M. S., Jansen, M., 2002. International and multidisciplinary efforts for the conservation of archaeological sites: Introducing sustainable and adapted Digital Three-dimensional Documentation techniques. *Virtual Congress – World Heritage in the Digital Age, the 30th Anniversary of the World Heritage Convention*.

Quintero, M. S., 2003. *The Use of Three-dimensional Documentation and Dissemination Techniques in Studying Built Heritage*. PhD dissertation, R. Lemaire International Centre for Conservation, KU Leuven, 2003.

Van Gool, L., Pollefeys, M., Proesmans, M., Zalesny, A., 2002. The MURALE project: Image-based 3D modeling for archaeology. In: *“Virtual Archaeology”: Proceedings of the VAST2000 Euroconference*, Oxford Archaeopress, Arezzo, Italy, pp. 53-63.

Van Gool, L., Waelkens, M., Müller, P., Vereenooghe, T., Vergauwen, M., 2004. Total recall: A plea for realism in models of the past. In: *Proceedings of the XXth ISPRS Congress, Commission V*, Istanbul, Turkey, pp. 332-343.

CONTEMPORARY DIGITAL METHODS FOR THE GEOMETRIC DOCUMENTATION OF CHURCHES IN CYPRUS

A. Georgopoulos, Ch. Ioannidis, Ch. Crysostomou, S. Ioakim, N. Shieittanis

Laboratory of Photogrammetry, School of Rural & Surveying Eng. NTUA, Greece
drag@central.ntua.gr, cioannid@survey.ntua.gr

KEY WORDS: Geometric documentation, Digital images, orthophotography, 3D visualization

ABSTRACT:

Recent advances in digital methods incorporating information technology have enabled the traditional surveyor – monument recorder to work faster, more accurately and in an automated way in order to produce advanced digital products, more versatile and –perhaps- more useful to the end users. Such methods include the digital imaging, the terrestrial laser scanning and the development of specialized software in order to fully exploit the digital data acquisition. In this paper two examples of the implementation of these methods in the geometric documentation of two churches, both significant for the history of Cyprus, is presented. It is concerned with the churches of Virgin Mary (Panayia) Podithou, in Galata and St. George Nikoxylitis in Droushia. The methodology and its merits are explained and the results are assessed for their usefulness.

1. INTRODUCTION

Monuments are undeniable documents of world history. Their thorough study is an obligation of our era to mankind's past and future. Respect towards cultural heritage has its roots already in the era of the Renaissance. During the 20th century archaeological excavations became common practice and they matured during the 20th century. Over the recent decades, international bodies and agencies have passed resolutions concerning the obligation for protection, conservation and restoration of monuments. The Athens Convention (1931), the Hague Agreement (1954), the Chart of Venice (1964) and the Granada Agreement (1985) are only but a few of these resolutions in which the need for geometric documentation of the monuments is also stressed, as part of their protection, study and conservation.

The geometric documentation of a monument may be defined as the action of acquiring, processing, presenting and recording the necessary data for the determination of the position and the actual existing form, shape and size of a monument in the three dimensional space at a particular given moment in time (UNESCO 1972). The geometric documentation records the present of the monuments, as this has been shaped in the course of time and is the necessary background for the studies of their past, as well as the plans for their future.

Geometric documentation should be considered as an integral part of a greater action, the General Documentation of the Cultural Heritage. This comprises, among others, the historical documentation, the architectural documentation, the bibliographic documentation etc. The Geometric Recording of a monument involves a series of measurements and -in general- metric data acquisition for the determination of the shape, the size and the position of the object in the three dimensional space. Processing of these data results to a series of documents, i.e. products, at large scales, which fully document the geometric -and other- properties of the monument. Usually such products include two dimensional projections of parts of the object on horizontal or vertical planes, suitably selected for this purpose.

Technological advances in recent years have spectacularly multiplied the variety of sources for collecting metric information at such large scales. In order to fully exploit these data special techniques should be developed. Moreover, the advancements in computer industry have enabled the three dimensional visualizations of the monuments in a virtual world. The compilation of 3D models of historical monuments is considerably facilitated by the use of dense point clouds, which are created by the use of terrestrial laser scanners. Their combined use with photogrammetric procedures, such as the production of orthophotos, allows the realistic 3D representation of complex monuments such as sculptures. In this context virtual reality tours have been created for simple or more complex monuments. This ability has greatly contributed to the thorough study of the monuments, as well as to the creation of virtual visits.

2. CONTEMPORARY METHODS

Nowadays, traditional surveying work has been greatly affected by technological advances. Telemetry, using electromagnetic radiation of many forms, and digital imaging have completely revolutionized the fieldwork, but also the variety of end products, as, at the same time, digital processing has also evolved dynamically. At the same time terrestrial laser scanning has been developed and has become another important and useful tool to enhance the quality and the variety of the end products.

Contemporary surveying and photogrammetric methods for the geometric documentation of a monument are always applied in combination (Ogleby and Rivett, 1985; Carbonnell, 1989). The required percentage of each one in each case depends on the accuracy specifications and on the level of detail, i.e. the qualitative information, of the monument required for the final product. These two main methods contribute to the final product. Classical survey measurements provide accurate determination of specific points, which form a rigid framework within which the monument details from the photogrammetric survey are being placed. This framework provides strong

interrelations of the measured points in 3D space, necessary as a base for the photogrammetric and other procedures.

Nowadays it is possible to produce highly accurate measurements of single points, collect point clouds describing any surface and determine the form, size and position of any detail, however complicated, from conventional or digital photographic images. The possible products comprise two-dimensional or three-dimensional vector or raster drawings in printed or digital form. The photogrammetric methodology is capable of providing adequate overall accuracy common for all points measured and details surveyed. The photogrammetric methods may be categorized to single image, or monoscopic, two-image, or stereoscopic, and to multi image methods.

Photogrammetry in principle uses photographic images of the objects of interest as raw data. Complicated techniques have been developed over the years in order to produce specialized visualisations – mostly orthogonal projections, vector or raster – of these objects of interest from these particular images. Lately sophisticated digital techniques have been developed in order to produce three dimensional views of these objects on computer screens, thus satisfying the necessity of the human observer to grasp the environment in 3D. The laser scanner technology has been employed to this very end for the benefit of geometric recording of monuments with highly impressive results. In this way the adventure path, which started at the real object with the direct measurements, returns to it via a series of digital processing, image transformations and representations (Figure 1) (Georgopoulos and Daskalopoulos, 2003).

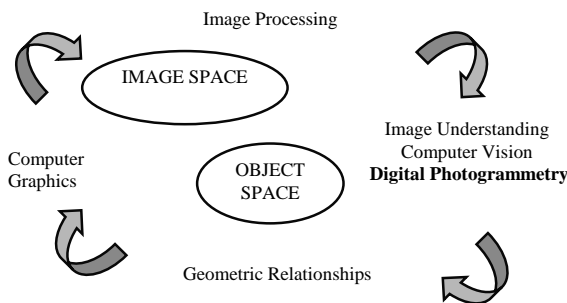

Figure 1: The round trip from object to image

3D modelling and visualization of monuments constitutes a very sophisticated and integrated method for the geometric recording, for the documentation and for the preservation of cultural heritage. It is particularly effective when applied for the documentation of significantly large and complicated monuments, not easily grasped in their entirety by human eye. When the 3D modelling is composed by high accuracy detailed data, it is in fact the final product of a long series of extensive processes with a number of intermediate products, such as 2D and 3D vector and raster plans.

Supported by laser scanning instrumentation and related software these 3D renderings together with traditional techniques may play an important role, as they are able to exploit the detailed work carried out by traditional surveying and photogrammetric techniques, which are characterized by indispensable accuracy and high detail content. Therefore for certain applications of 3D visualization of objects, classical techniques are and should still be used with impressive results.

As an alternative solution for the production of 3D textured models, software packages incorporating photogrammetric algorithms of multi-image management with bundle adjustment can be used. By pointing manually and monoscopically on homologue points on more than two overlapping images the optimum ray intersections are determined. For better accuracy and more reliable data determination, images should be taken rather with a convergence of 20°-90°, instead of the desired normal case of the conventional procedure of stereorestitution. The creation of the model is achieved by selecting points that create planes or other mathematical surfaces (parts of cylinders, cones or spheres) and by adding geometric constraints in space.

A big advantage of these packages, e.g. PhotoModeler of Eos Systems Inc, 3D Builder and others is the simplified and user-friendly interface that they offer, since they are designed mainly for non-photogrammetrists. Their basic problems are the lack of automated procedures, for example matching, which increases the required workload, and the insufficient ways for the assessment of the achieved accuracy. However, it is a cost effective solution with interactive processing for the 3D geometric recording of monuments and without any need for special knowledge of photogrammetry. Most of them have the ability of:

- Self-calibration or introduction of interior orientation parameters, allowing the use of non-metric cameras.
- The use of lines between points for the determination of the delineation of the objects.
- Imposing constraints, such as collinearity or coplanarity of points, perpendicular or parallel lines.
- Determining epipolar lines facilitating the location of homologue points.
- Producing models without control points, while the scale is determined by measured distances.
- Adding to the model mathematical surfaces, such as cylinders or other second order surfaces.
- Producing orthoimages at defined projection planes.
- Creating TIN and wireframe models.
- Applying texture to the model from images selected manually or automatically, and producing of photorealistic renderings.
- 3D viewer, with zooming, rotating and measuring capacity on the model.

3. IMPLEMENTATION

The above presented contemporary methods have been used in order to geometrically document two churches in Cyprus. This action is part of a larger research project, which aims at the geometric documentation of all Byzantine Churches on Troodos Mountain. Ten of these churches are included in the World heritage list of UNESCO, mainly because of their famous wall paintings. The two churches of the present study have completely different characteristics and, hence, they are fine examples of the usability and adaptability of the methods, in order for the optimal result to be achieved.

These two churches are Virgin Mary (Panayia) Podithou, near Galata village on Troodos mountain and St. George Nikoxylitis near Droushia village in the western part of the island (Figure 2). They were selected as they are representative specimens of religious architecture of Cyprus.

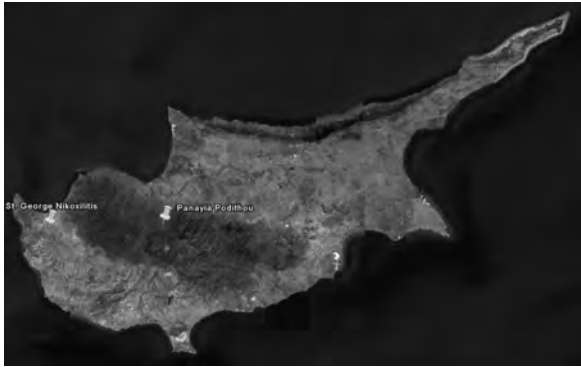

Figure 2: The location of the two churches on Cyprus

3.1 Church of Virgin Mary in Podithou

The Church of Virgin Mary (Podithou) is the Katholikon of an old Monastery founded in the late 14th c. AD. Buildings of the Monastery surrounding the Church stood until the 1950's, when they were demolished. The church is a single space basilica surrounded by a pi-shaped corridor (Figure 3) and covered by a double sided roof made of stone slabs. The external dimensions of the church are 11x17.70 m and the maximum height of the roof is approx 11 meters.

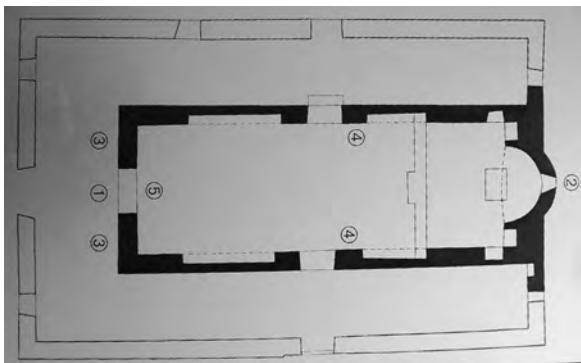

Figure 3: The plan of the Church Podithou

This particular church belongs to the ten Byzantine painted Churches of Mount Troodos, which belong to the World Heritage list of UNESCO (Figure 4). They are famous for their architecture, but mainly for their marvellous wall paintings. The monument is under the patronage of the Holy Metropolis of Morfou and the Department of Antiquities of Cyprus.

3.2 Church of St. George Nikoxylitis in Droushia

The Church of St. George Nikoxylitis is part of an old Monastery, which is situated about 3 km north of the village of Droushia, on the western part of Cyprus. The Monastery has been established back in the 10th century, or even earlier. This monument is under the patronage of the Department of Land Consolidation and of course the Department of Antiquities of Cyprus.

There are no reliable sources about the exact date of the establishment of the Monastery, as there are no explanations about the strange adjective escorting the name of the Saint either. Only wild speculation may be used to attribute the name

to the large amount of wood (= xylo in Greek) which may be found in the area (Figure 5).



Figure 4: The church of Virgin Mary (Panayia) Podithou



Figure 5: The aerial view of St. George Nikoxylitis

The church surviving today was rebuilt, using material of the older church, in the early 1920's on the exact position of the ruined old church of the Monastery, remnants of which may be distinguished today.

The church is a single space basilica, initially with a vaulted roof (Figure 6). The roof seen today has been added later for reasons of protection. The outside dimensions are 13x7x8 m. Along the two long sides of the church there are eight rectangular pillars, which support four inner vaults and the roof. The bell tower was destroyed in 1923 and was replaced by a simple pi-shaped and 1.5 m in height construction on the western part of the roof.

4. METHODOLOGY

For the geometric documentation of these two churches various contemporary methods were employed like the ones mentioned above. They were selected in such a way as to suit the peculiarities of each monument and serve the final products in the best possible way as far as accuracy, completeness and quality are concerned.



Figure 6: The western façade of the Church of St. George

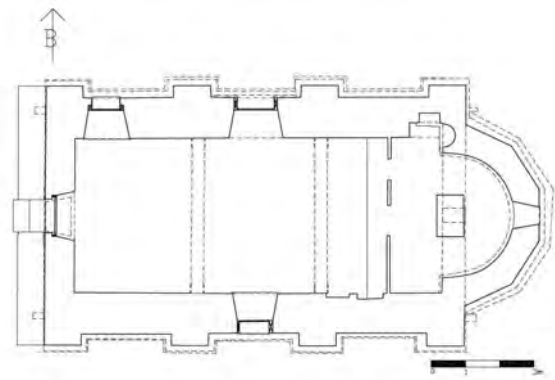

Figure 7: The plan drawing of the church of St. George

Specifically, for the Church of St. George Nikoxylitis it was decided to produce orthophotos for the four main façades, a horizontal section of the monument, two main vertical sections along and across the church and a general survey of the surrounding area. On the other hand, for the Church of Virgin Mary Podithou it was decided to produce a 3D visualization of the monument in addition of the standard products as above.

The employed instrumentation included a digital camera (Canon MII™ 8Mpixel) with a set of appropriate lenses (24mm, 16-35mm and 28-85mm), a terrestrial laser scanner (HDS/Cyrax 2500™) and a Pentax R-323NX™ reflectorless laser total station. For the photography around the church of St. George, a special forklift vehicle was also employed for enabling branch cutting and of course photography. Pre-marked targets were used as ground control points for both churches were possible. For their co-ordinate determination standard surveying procedure was employed with special care for the accuracy of the final calculations. All targets were determined with an accuracy of less than 20mm, as the final scale of the drawings was set at 1:50.

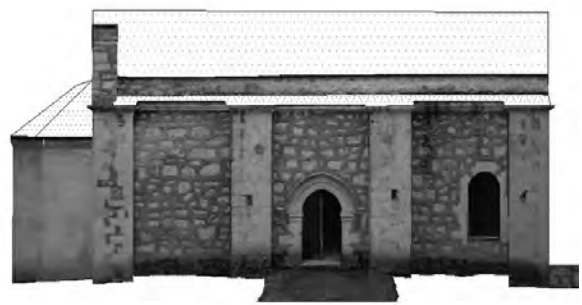

Figure 8: The not yet completed north façade of the church

It was decided to use different combinations of the available contemporary methods described above for the geometric documentation of the churches. In this way the best possible results will be produced in each case. For the orthophoto production of the Church of St. George standard digital rectification was employed for the planar parts and digital stereophotogrammetry for the non planar ones. In Figures 7 and 8 specimens of the first results of the geometric documentation are presented. For the geodetic measurements standard surveying technology was employed.



Figure 9: The complete point cloud of the Church of Podithou

Multiple rectifications of the large scale images were performed for the production of the raster products, i.e. orthophotos. Special methodology is required for their completion with the roofs. The project is not yet complete as efforts are still going on in order to complete the production of the final drawings.

The registered point clouds acquired around the church were later used to produce a 3D visualization of the monument. Multimedia enhancement of the latter produced a video depicting a virtual visit around and inside the monument. In any case scanning of the monument from positions around it were acquired and they were later combined to a unique point cloud with suitable registration (Figure 9).

For the orthophotos of the Church of Podithou, a somewhat different approach was employed; at least as far as the roof part is concerned. A simpler method for producing orthophotos involves relation of a point cloud to a digital image, in order to assign colour information to the points in space. The then coloured point cloud may be projected onto any desired projection plane in order to produce the orthophoto (Georgopoulos and Natsis, 2008a; 2008b).



Figure 10: A digital image used for the Photomodeler™ software

The same result for the 3D visualization was achieved employing another methodology, intended for non rigorous applications, as mentioned before. The Photomodeler™ software was employed in order to combine information from suitably taken digital images (Figure 10) in order to achieve the final result.

This software actually employs the standard bundle adjustment method in order to relate the available images with each other and with the object itself. It then gives the possibility to the user to produce a 3D textured model or the orthogonal projection of that model to predefined planes. In Figure 11 a view of the rendered 3D model produced with Photomodeler™ is presented.



Figure 11: The 3D textured model produced with Photomodeler™ software

The orthophoto in Figure 12 has been produced by the orthogonal projection of the 3D textured model. It is planned to proceed with the production of the full range of products for the geometric documentation of the churches and perform a thorough comparison for assessing their accuracy, wealth and reliability of content and, of course, time and cost.

A first comparison of these products in terms of time, cost and reliability proves that the employed methods are relatively fast, compared to the traditional photogrammetric procedure. This is valid both for the field work and the processing stage. Accuracy tests will be performed as soon as all products have been finalized.



Figure 12: Orthophoto produced by suitably projecting the 3D textured model

5. CONCLUDING REMARKS

It has been shown that the suitable combination of contemporary methods of surveying, photogrammetry and terrestrial laser scanning, with the help of suitable software may provide in a relatively short time invaluable results to the experts who take care of the well being of Cultural Heritage. The first results of these two projects presented in this paper only prove that there is great potential in these contemporary methods.

6. REFERENCES

- Carbannel, M., 1989. Photogrammetry Applied to Surveys of Monuments and Historic Centres. In: *Proceedings of ICCROM*, Rome, Italy.
- Daskalopoulos, A., Georgopoulos, A., Ioannidis, C., Makris, G.N., 2003. A trip from object to image and back. In: *The International Archives of Photogrammetry, Remote Sensing and Spatial Information Sciences*, Ancona, Italy, Vol. XXXIV, Part 6/W12.
- Georgopoulos, A., Natsis, S., 2008a. A simpler method for large scale orthophoto production. In: *The International Archives of Photogrammetry, Remote Sensing and Spatial Information Sciences*, Beijing, China, Vol. XXXVII, Part B5, pp. 253-258.
- Georgopoulos, A., Natsis, S., 2008b. Evaluation of a simpler method for large scale orthophoto production. In: *Proceedings of VSMM 2008*, Lemessos, Cyprus (in print).
- Ioannidis, C., Georgopoulos, A., 2007. Innovative Techniques for the acquisition and processing of Multisource data for the Geometric Documentation of Monuments. *International Journal of Architectural Computing*, Issue 02, Vol. 05 (June 2007), pp. 179-198.
- Ogleby, C., Rivett, L., 1985. Handbook of Heritage Photogrammetry. *Australian Heritage Commission Special Australian Heritage Publication No 4*, Canberra.
- U.N.E.S.C.O., 1972. Photogrammetry applied to the survey of Historic Monuments, of Sites and to Archaeology. *UNESCO editions*.

7. ACKNOWLEDGEMENTS

The support of the Church of Morfou and the Archbishop Neofytos himself is gratefully acknowledged. Moreover this work has been also fully supported by the department of Land Consolidation and the Department of Antiquities of Cyprus. Special thanks are due to Kyriacos Nikolaou, Giannoula Rossides and Eleni Solomou of the Dept. of Land Consolidation for their non-ending efforts. The support of Cyprus Airways for the transport of the instrumentation is also acknowledged.

BRINGING BACK THE LOST MONUMENT: INTERACTIVE VIRTUAL MODEL OF SOMPUR MAHAVIHARA, BENGAL

Md Mizanur Rashid^{a,*}, Hafizur Rahaman^b

^a Department of Architecture, National University of Singapore, 4 Architecture Drive, Singapore 117566 –
akimmr@nus.edu.sg

^b Centre for Advanced Studies in Architecture, National University of Singapore, hrahaman@gmail.com

KEY WORDS: Sompur Mahavihara, Virtual Heritage, Interactive Model, Participatory Approach

ABSTRACT:

This study aims at developing an interactive virtual model of the lost architectural heritage of the 8th century Buddhist Monastery of Sompur Mahavihara in Bengal. This monument at Paharpur drew the attention of the architectural historians of the South Asia from the very discovery of the ruins of the structure at the beginning of the twentieth century because of its unique architectural features and strategic spatio-temporal location. Several attempts have been made so far to recover the memories of this medieval Buddhist Monastery after the amnesia of a millennium. However, the limited amount of archaeological resource, literary evidences and epigraphic records at the disposal of the architectural historians appears as the main thicket. This study is an attempt to generate an interactive virtual model of the monument that would accommodate different contesting narratives regarding its architecture. It looks into the history in a more dynamic way and uses virtual reconstruction as flexible tool to reconstruct the lost form of the building. The main idea is to develop a method conserving, retrieving and commemorating the both tangible and intangible aspects of the heritage through the participation of the general public. This model will be used as a virtual museum for continuous and feedback and verification from scholars and aspiring general public and eventually refine the model based on these feedback. This participatory approach of reconstructing will minimize the distance between the people and object of heritage as well as engender a new way of experiencing, evaluating and appreciating heritage buildings.

1. BACKGROUND

1.1 Introduction

Since its discovery in the early twentieth century the ruins of Sompur Buddhist monastery became the focus of the scholars of the architectural history of Bengal. This mega structure became a landmark in the history of architecture for two reasons. Firstly it marks an important transition between the subconscious and vernacular mode of architecture to the most conscious, symbolic and metaphoric mode. Secondly, it represents a particular era when Buddhism had its last stronghold under the royal patronage of the Pala kings and gradually transformed into a more ritualistic practise than the philosophical doctrine as preached by Buddha, which is known as neo-Buddhism (Chatterjee, 1985) or 'Tantric' Buddhism. Considering its cultural and historical significance, UNESCO has inscribed it as a World's Cultural Heritage Site in 1985.

1.2 The Problem

The most striking architectural feature that distinguished Sompur Mahavihara from the other Buddhist monasteries found in India is the central cruciform structure (Figure 1). Hence most of the debates generated hitherto on the architecture of Sompur mahavihara are centred on the missing superstructure as well as its layout, configuration and architectural details. The ruin of the structure rises upward in a tapering mass of three receding terraces, which reaches a height of 23 meters. Each of the terraces has a circum-ambulatory passage around the monument. At the topmost terrace (of the existing ruin) there were four antechambers on the projecting arms of the cross. The over all design of this complicated architecture is centred on a

square hollow shaft, which runs down from the present top of the mound to the level of second terrace.

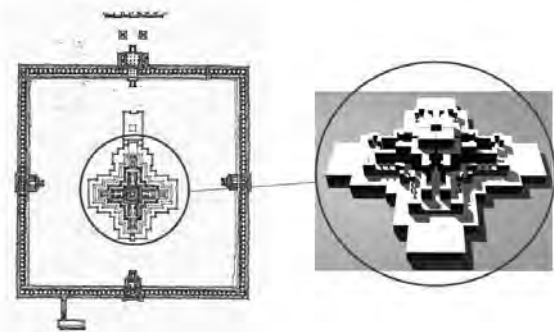

Figure 1: Plan of Sompur Mahavihara and the reconstructed model of the central structure

Sompur Mahavihara is definitely the mostly studied historical monument in Bengal. There exist different arguments regarding the three-dimensional articulation of the missing superstructure. There are also some attempts of theoretical reconstruction of the central structure by different scholars. However, the nature and the extent of the earlier studies are not sufficient to generate necessary potential for a discourse. The reason may be manifold, but the most important one is the non-availability of substantial amount resource including a comprehensive architectural documentation at the disposal of the researchers. The first hand evidences like the archaeological remains are mostly at foundation level and inadequate. The epigraphic records remain almost mum regarding this monument.

* Corresponding author. This is useful to know for communication with the appropriate person in cases with more than one author.

Consequently, most of the works done so far are mainly limited on the findings of the archaeological excavation and studying the artefacts from the archaeological perspective. Hence the history Buddhist architecture in Bengal is yet to recover from the amnesia of centuries.

2. BEGINNING

2.1 From Constraints to Opportunity

We have already mentioned that the earlier attempts of understanding architecture of this monastery were unsuccessful because of the limited resources. It is almost impossible to depend solely on materials that are available at first hand to demonstrate a continuous narrative of this monument. However the lack of physical resources could be transformed into opportunities than constraints for followings reasons.

1. The lack of sufficient physical resources may be a hindrance to demonstrate a tentative description of architecture. Nevertheless, It at the same time would help us to deconstruct any preconceived notion from the beginning. The apparent amnesia could be seen as a great opportunity to understand the building process of the monument from a very neutral point of view. It may not give us a very accurate understanding of the individual architecture but it would lessen the risk of deviation because of the wrong interpretation of the archaeological ruins. Especially for the case of Sompur Mahavihara, where most of the architecture is missing we could use this situation to too look at the problem from a broader perspective and in a much flexible way. The focus of the study should be turned from the product to the process to use the fullest extent of this scope.
2. It further opens up a ground for accommodating the earlier studies and contesting hypothesis. The apparent discrete nature of the approaches of these earlier works does not necessarily indicate a disjunction. Rather it demonstrates the array of possibilities of looking at the problem. Putting them together in a common platform and a critical analysis may give us much clearer picture of the problem. The idea is not to debunk them or the assumptions upon which they are based, but to develop an integrated approach that includes all the possibilities and scopes. Eventually it may establish a theoretical framework for further study by accepting, criticizing and refuting some of these earlier assumptions. This study can be considered as an addition to the existing body of knowledge. The terrain will not only be much richer once all the ideas and hypothesis will be put together but also offer a much wider scope to fill up the lacuna.
3. As architecture this building is a part of the material culture of this region. The determinants of the material culture of particular location such as the tradition and world view of the people, the custom of reverence, symbol and rituals of expressing status, gender relationship, the sepulchral tradition etc exist in a layered manner. Religion acts as an additional layer in these whole set of accumulated layers. These layers are not only overlapped with each other but also maintain an osmotic relationship of continuous transformation of ideas and themes in between them. Hence, the religious architecture is a result of a contestation of multiple themes, ideas and authorship. Because of the

amorphous nature of the religion, Buddhist religious architecture is much susceptible to changes due the cultural paradigm both in terms of form and meaning. This is not as simple as borrowing some elements from the other or adopting some style of expression. It is deeply rooted at the very conception of architecture or piece of art. Hence once we could understand the process and discern the layers that acted we would be able to understand the architecture as well. That means we have to look into the history in a more dynamic way and use all the available tools. We need to use information from different sources and to evaluate the problem of architecture from a much broader perspective.

4. Virtual modelling can be used as a useful tool for multiple verification and criticism. It is not directed towards the end product as photographic realization of the original structure of *Sompur Mahavihara*. On the contrary, it concentrates more on developing a method of evaluation and synthesis to conceptualize the formal expression of the structure. Virtual reconstruction is to be applied in two levels for doing so. At one level it should be used to develop an exact visualization of the existing remains of the structure to be used as the basis for further study. The next level of modelling involves a comprehensive process of evaluation and verification. Main objective of this level is to generate a process of theoretical reconstruction of the structure by using all the available information. It is difficult from the presently available material to come up with a single model of the central structure. Hence the present study may end up with several theoretical models of the Sompur Mahavihara based on different contesting hypotheses. This process of theoretical restoration and interpreting available information is a continuous one. What would not be found today can be kept for the future to comprehend, provided that the present information is not destroyed (Forte and Silliotti, 1997). Even the corrections and criticisms and debate can be accommodated by the successive reconstruction. It is perhaps the most flexible means using all the available resources that are apparently inconspicuous in nature.

2.2 The preliminary reconstruction

Hence it is important here to understand the process through which architecture is conceived and materialized. We have started our study from a much broader perspective to develop a broader picture of Buddhist religious building and tried to identify the location our case within this. Then we gradually zoom down by discerning each of the layer one after another.

We tried to develop a system where the threads all the available resources will be put together in a scientific manner to construct the bigger scenario. We kept the other end of the thread for inflow of the future resources so that the model or the proposal can be modified when newer resources would be available. Based on this a three dimensional virtual model has been developed at the end. In this work an attempt was made to understand the lost architectural features of the monument by using these cross-disciplinary resources in a systematic manner. It looked into the history in a more dynamic way and uses virtual reconstruction as a flexible tool to reconstruct the lost form of the building. Based on this we developed a preliminary virtual model for the central structure of Sompur Mahavihara (Figure 2).

The main objective of this work was not to retrieve the architectural form as it was originally, which is not possible with nature of the available resources as well. Rather it focuses mainly on the collation and the examination of all the available resources that may have had some impact on the architectural form of Sompur Mahavihara, and put them in a framework so that we may have a better idea regarding its possible three dimensional manifestations. At the end a framework of knowledge regarding this monument was developed for future feedback (Figure 03). The most important aspect of the framework is that it not only relies on architectural or archaeological sources, rather it adopted a cross disciplinary approach. Hence any small discovery at any discipline can be used in this framework to observed how it will affect the three dimensional expression of this structure. Due to the limitation of time, this is study focused mainly on the central structure and considered only the formal aspects of architecture.

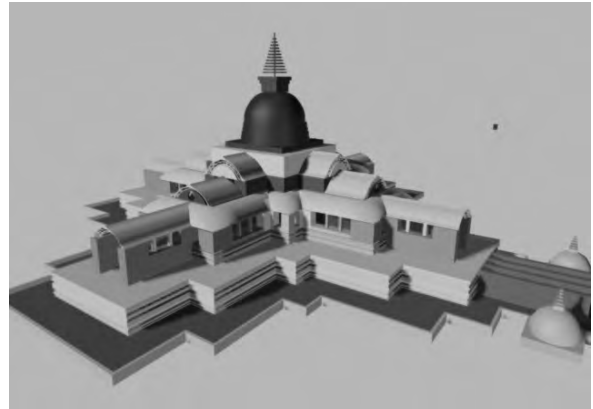

Figure 2: Preliminary Reconstruction of the lost central structure of Sompur Mahavihara

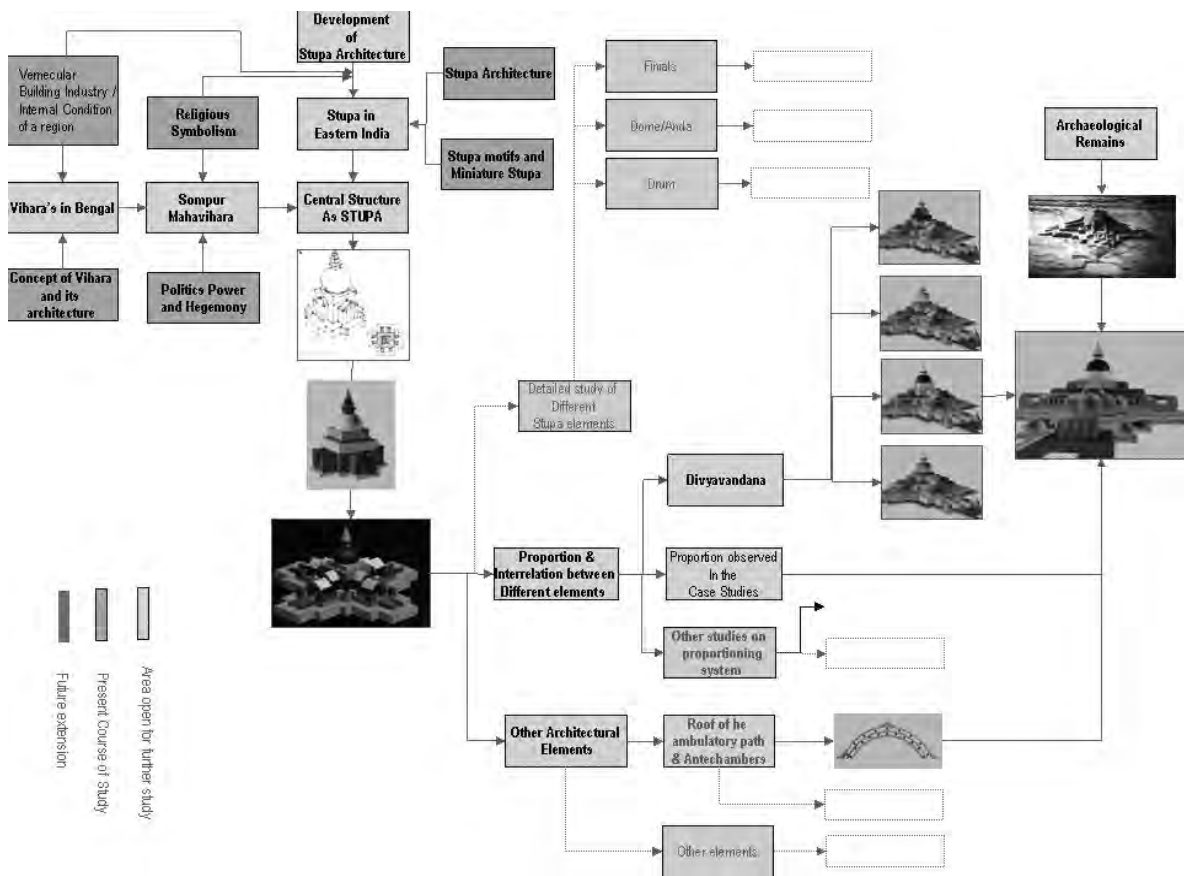

Figure 3: The framework of knowledge for the reconstruction

3. PRESENT STUDY; THE SECOND PHASE:

3.1 Objective

This second phase of the study is built on earlier reconstruction. During the process of the earlier reconstruction a distance between a heritage building and public drew our attention. Especially in the case where the heritage building is presently ruined (like our case) and a limited amount of archaeological resources are available to fill up the lacuna. It is a great

challenge for the architectural historians to bring back this building to and its architecture based on this fragmented resources that are mostly inconspicuous in nature. In our previous reconstruction an attempt was made to recover the architectural form of the lost monument of Sompur Mahavihara. However it was felt that it was almost impossible to retrieve the lost form as it was, rather it was more convenient to collate and examine all the available resources that may have had some impact on the architectural form of this building. The idea was to develop a process that is open for future feedback and

correction. Now the question that comes in front is whether this recovery of architectural form is sufficient enough to understand the building as well as enliven the memories of the heritage back to the people and minimizing the distance between the people and the heritage. In this juncture the concept of 'Virtual Heritage' has emerged. Roussou (2002) described Virtual Heritage as an intersection of virtual- reality and cultural heritage. She further defined the functions of virtual heritage to facilitate the synthesis, conservation, reproduction, representation, digital processing and display of cultural evidences. There already exists example of Virtual Archaeology (Barceló 2000), where some archaeological sites have been reconstructed for three dimensional experiences. Nevertheless whether they are playing a successful role for heritage conservation is questionable. From the earlier examples it seems that that the end product (reconstructions of the lost buildings or sites) remains within the domain of academia. A few of them are merely published in websites, media or open to public spaces in museums. However, the broader definition of Virtual Heritage demonstrates a process that involves not only different disciplines (e.g. Architecture, Computation, History, Heritage and Museum studies, Cultural Studies etc) but a wider spectrum of people. It certainly needs a participatory approach to fully recover the memories of the building. The proposed study would embark on this premise.

Maria Roussou (2006) has defined three challenges for public presentation of virtual heritage, they are:

- Representation (to accurately visualize or visually reconstruct the data)
- Experience (to present and enhance the virtual environment with elements that incorporate knowledge providing and vision) and
- Interaction (to provide ability to gain insights by actively engaging in and even modifying the experience)

Dourish (Dourish 2001) also emphasized on participation, task accomplishment and practical action for an effective embodiment with the environment. As successful interactive experience can only be achieved while a person feels interest with the content, poses empathy with it and finally can imagine the alternate reality (Schell and Shochet 2001) and that can only be achieved through proper interaction.

An architectural heritage is something more than the physical form. A building is a place for doing different activities. Especially spaces inside a religious building, e.g. Sompur Mahavihara, are precisely guided by the rituals and performances. To understand the architecture of this monument, mere virtual reconstruction of the three dimensional form would not be sufficient. In order to create virtual environment embodying the essence of place is inevitable (Jumphon 2008). Usually the role of 'Place' in virtual environments has been as a locator of objects (Champion and Dave 2002). But Kalay (Kalay and Marx 2001) pointed out that 'Places are created through inhabitation. People imbue space with social and cultural meaning, transforming mere space into a place'. Hence we need to know how this design of the building is conceived through the organization of different spaces within it. Being a monument that belongs to high Tantric phase of Buddhism in Bengali, the architecture of this monument was certainly determined by Tantric rituals and rites. The movements of monks within the complex, their daily life and periodic ritual performances had significant importance in the spatial

organization of Sompur Mahavihara. Hence to recover of the memories of this building we have to examine the the aspects how spaces were generated, interpreted and interconnected with respect to the daily activities of the monks and the ritual performances. We have to analyse different activities and the ritual performances within the monastery and try to reconstruct the virtual model focusing on the aspects of spatiality.

This proposed study is designed to address these issues regarding the lost heritage building taking *Sompur Mahavihara* as a case. It is aimed to fulfil these following objectives:

1. To develop an interactive virtual model of Sompur Mahavihara focusing the aspects of spatiality.
2. To minimize the distance between the general public and heritage building by developing participatory reconstruction process using bringing this interactive model. It could be virtual museum that would allow the people to participate, educate, attach and preserve their memories associated with this building.
3. To collate the feedbacks from scholars and aspiring general public to verify and further develop the earlier framework of knowledge regarding this monument. The most important aspect of the framework would be that it would not only rely on architectural or archaeological sources, rather it would adopt a cross disciplinary approach. Hence any small discovery at any discipline can be used in this framework to observe how it will affect the three dimensional expression of this structure.

3.2 Significance and Innovation

Our current study is designed to address two fundamental problems. Firstly, the problem that lies inherently with the reconstruction/conservation of the lost archaeological monuments. A historical building is a memory of past and it should be preserved for its particular location in the history. However, is it only the commemorative value that we take into account? We don't think so. Actually a monument poses wide ranges of values, both tangible and intangible, towards itself. The physical conservation in its true form not only ensures the formal characteristics of the monument, but at the same time put a considerable impact on the others, especially on the intangible aspects. To preserve this whole set of values we need a detail inventory of information before going into a physical conservation of the monuments, because if the conservation attempt goes wrong it becomes hazardous enough to destroy the whole set of tangible as well as intangible values. This phenomenon is of utmost importance in the cases like *Sompur Mahavihara*, where archaeological information is really scarce. Hence, it is more practical and rational to go for an interactive virtual model, which eventually addresses all the related issues and disciplines. The premise upon which the initial model was developed considered architecture as a cultural product. As architecture this building is a part of the material culture of this region. The determinants of the material culture of particular location such as the tradition and world view of the people, the custom of reverence, symbol and rituals of expressing status, gender relationship, the sepulchral tradition etc exist in a layered manner. Religion acts as an additional layer in these whole set of accumulated layers. These layers are not only overlapped with each other but also maintain an osmotic relationship of continuous transformation of ideas and themes in between them. Hence, the religious architecture is a result of a contestation of multiple themes, ideas and authorship. This is not as simple as borrowing some elements from the other or

adopting some style of expression. It is deeply rooted at the very conception of architecture and its use. Hence once we could understand the process and discern the layers that acted we would be able to understand the architecture as well. That means we have to look into the history in a more dynamic way and use all the available tools. We need to use information from different sources and to evaluate the problem of architecture from a much broader perspective. In this proposed study, we would focus more on the spatial aspects that involved ritual performances within this building. This has potential to contribute significant knowledge in the field of spatial theory and architecture. Architecture is no more a discipline to be looked at by the architects and the archaeologists. A building is a result of different accumulative layers. And these layers should be unravelled and discerned if we really want understand the building. Hence this study offered an opportunity to look into architecture from a different perspective. A view of this building from different perspective has the opportunity to discern certain layers that render its overall architectural form. A comparison of this spatial model with the formal model of the building may lead us to reveal some of the intangible values related to this monument.

The second problem deals mainly with distance between the architectural knowledge of the general people. Because of the very inherent problem of the discipline certain gap has been maintained between the great architectural masterpieces and general public. These great monuments were considered more as objects / exhibits rather than space for activities and performance by the common people. They have very little role to play either in conservation or evaluating these monuments. The lost monuments, like our case has very little or no impact on the general architectural knowledge of the common people. However, they not only have significant historical and commemorative value but possess certain degree of cultural value as well. Hence it is important to let the people participate in the process of understanding this architecture. The intention is not to retrieve the lost architecture of this monument but to develop an interactive process where the distance between the general public to the monumental architecture could be minimized. The applied aspect of this study is that the iconic building would no longer be something; you should look from a distance. If we could incorporate contemporary studies on media and museum studies with this reconstructed spatial model then this interactive model could be a powerful tool to understand the architecture as well as life in this old monument and as an educational source for both aspiring student and general public.

3.3 Approach and Methodology

This research will combine architectural history with museum studies using the virtual technology as tool. As an architect I would be able to take care of the architectural part of the study, whereas for the other part like people's participation with the virtual model I would rely more on the expertise on the department of museum studies. The approach and the research procedure is divided into three major parts according to the research objectives.

1. Developing a comprehensive and interactive virtual model of Sompur Mahavihara: The major objective of this part of the study to develop a holistic and comprehensive architectural model of the lost heritage building, which would be used in the later part of the study. Being a monument that belongs to the high tantric phase of the

Buddhism, this architecture certainly played a role as a stage for different ritual performances. As the objective of this part of this study is to understand the spaces of the monument in terms of ritual performance, a significant amount of time would be spent for observing and documenting contemporaneous Tantric rituals. Based on this study we would develop a preliminary spatial model for this lost monument. This model would be compared with the previously developed formal model to develop the final interactive virtual model for public's interaction. This model would not be photo realization of the original monument as Osberg (1997) identified that abstract drawing/ view is more effective and better understood than the highly realistic one. Hence, it concentrates more on developing a method of evaluation and synthesis to conceptualize the Architecture of the monument.

2. Bringing/conveying this interactive model to a wider spectrum of people by using website, museum installation and other means: In this part I would try to develop different means to convey this model to people from different spectrum for interaction and feedback. This model would be published in website to bring it to a larger community of scholars and other people. At the same time some smaller installation will be erected in different public places like Museum, Educational Institution and libraries so that the aspiring students and general public people can participate and interact with the model. Unlike the most Virtual heritage model this model would incorporate the cultural information or the 'intangible part of the heritage' (associated folk tales, local believes, religious believes, oral history etc) with the tangible one. It would not only be restricted with the developer's own narrative rather the users could personalize the interface or changed the story board if needed. These models or installation would be continuously monitored for collating feedback and accommodating, altering and even sometime rejecting the ideas for further modification of the model and framework of knowledge.
3. Collating the feedback and organizing the framework of knowledge and modify the virtual model accordingly: In this part of the study we would collate all the feedback regarding architecture of this heritage from the different input sources and then deduce logical inference by using this information. We would look into the problem in a more architectural way and fill up the gaps using architectonic reasoning. This might not give us a definite solution regarding the original form of the building but it generates a process of learning and evaluation. The main contribution of the study would not only the development of this interactive framework of information that is open for necessary feedback future and refinement of the virtual model, the most important part is to educate and attach the people with the lost heritage and let them participate in the process of conservation of this cultural heritage and preserve the memories. This framework will just try to compile all the available information and interlink them in a systematic way for the virtual reconstruction. The most important aspect of the framework is that it not only relies on architectural or archaeological sources, rather it would depend on wide varieties of sources. Hence any small discovery at any discipline or a little feedback can be used in this framework to observed how it will affect the three dimensional expression of this structure.

4. CONCLUSION

Mostly virtual reconstruction are developed by researchers and academicians (except movie industries for entertainment) requiring extensive labour and high expertise. However, the end product (3D models/environment) remains within the domain of scholars and academia. A few of them are merely published in websites or delivered to public spaces like museums. Again, present VR technologies for public viewing, poses a variety of practical limitations including high cost, development complexity and maintenance. Practical issues and problems are especially apparent when visitors have to follow a default narrative and merely can personalize or engage with the content restricted by their own cultural and technical background. In our case this interface will be developed as a virtual museum exhibit enhanced by user's cultural background, where user can easily participate with the content, personalize their way of retrieving information through an interface which can track human movement/gesture and response in real-time. We hope, by incorporating the cultural background of user while designing the interface will provoke a new way of experiencing, evaluating and appreciating heritage buildings. In our previous study we have reconstructed a virtual model of the lost mind. Once completed this study would demonstrate a methodology that can be adopted for any other heritage site or building anywhere in the world, which is presently in ruinous condition. The main idea of this study is to develop a process through which the distance between the people and the heritage building can be minimized through interaction and at the same time to conserve the memories of the building while searching for its architectural form.

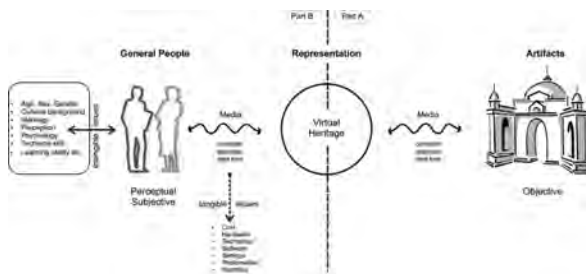

Figure 4: The possible scheme of the study.

5. REFERENCES

Reference from Books:

Chatterjee, R. (1985). *Religion in Bengal; During the Pala Sena Time*, Punthi Pustak, Calcutta.

Dourish, P. (2001). *Where the action is : the foundations of embodied interaction*. Cambridge, Mass., MIT Press.

I-Tsing, *A Record of Buddhist Religion as Practiced in India and Malayan Archipelago*, Ch XXXII. Translated by J. Takakusu (1962)

Maurizio Forte and Alberto Silliotti (1997), *Virtual Archaeology*, New York,

Osberg, K. M. (1997). *Constructivism in practice: the case for meaning-making in the virtual world*, University of Washington.

Staley, D. J. (2002). *Computers, Visualization, and History: How New Technology Will Transform Our Understanding of the Past*, ME Sharpe.

Reference from Journals:

Barceló, J. A. (2000). "Visualizing What Might Be. An Introduction to Virtual Reality in Archaeology." *Virtual Reality in Archaeology* 843: 9-36.

Chan Lin, L. (2001). "Formats and prior knowledge on learning in a computer-based lesson." *Journal of Computer Assisted Learning* 17(4): 409-419.

Heilig, M. L. (1992). "El cine del futuro: the cinema of the future." *Presence: Teleoperators and Virtual Environments* 1(3): 279-294.

Roussou, M. (2002). "Virtual Heritage: From the Research Lab to the Broad Public." *Virtual Archaeology*: 24-25.

Reference from Other Literature:

Belaën, F. (2003). "L'immersion au service des musées de sciences." Proceedings of ICHIM Conference 2003: Cultural institutions and digital technology. Paris, Ecole du Louvre.

Champion, E. and B. Dave (2002). "Where is This Place." Proceedings of ACADIA Conference 2002: Thresholds Between Physical and Virtual: 87-97.

Kalay, Y. and J. Marx (2001). "Architecture and the Internet: Designing Places in Cyberspace." Proceedings of ACADIA 2001: Reinventing the Discourse: 230-240.

Roussou, M. (2006). "The components of engagement in virtual heritage environments." In Proceedings of New Heritage : Beyond Versimilitude - Conference on Cultural Heritage and New Media, Hong Kong: 265-283.

Schell, J. and J. Shochet (2001). "Designing Interactive Theme Park Rides."

Cultural Heritage Resource Information Systems

NEMO SYSTEM: NEW MUSEUM APPROACHES - DEVELOPMENT OF PORTABLE NAVIGATION SYSTEMS FOR EXHIBITIONS

Michael Charakis.

Charakis Research & Consulting Ltd, Managing Director, 10 Kosta Charaki Str., Limassol, Cyprus,
mcharakis@crccy.com

KEY WORDS: Navigation, location-based services, content promotion, mobile application.

ABSTRACT:

NEMO project involves the development, design and implementation of a location-based information system for cultural heritage content. Within the scope of “**NEMO**” project, was the development of a software platform for handheld and mobile computing devices (known as Personal Digital Assistants: PDAs), which are employed by the visitors of cultural heritage sites. **NEMO** system allows the process and the presentation of content in real-time based on the location of the visitor within the physical space, providing the following capabilities: 1.Retrieval of Multimedia Exhibits, 2.Interactive tours in the site, both predefined and free tours, with embedded audio – video and textual information, 3.Retrieval of information in different levels according to the available time of the visitor within the physical space. In the context of the specific project a client-server architecture was developed, based on Java technology (J2ME) for mobile devices, which enabled the functionality of distributing multimedia content form the Server to the Clients of the system. The content was provided to the clients of the system based on the position of a specific the client in the space. The localization of the client was determined through the utilization of wireless network 802 11.g. This innovative approach provided us with the exact localization of the client in 34 distinct locations within the physical area of the museum, with a precision varying from 0% to 0.3% position error, by utilizing a set of 18 wireless antennas (including the redundant access points) and the same time providing simultaneously content to 4-5 clients (visitors).

1. INTRODUCTION

1.1 General Information

The **NEMO** System is the result of the research program: **New museum approaches - development of portable navigation systems for exhibitions- NEMO**.

The **NEMO** project involves the development, design and implementation of a location based information system for cultural heritage content. Within the scope of “**NEMO**” project, was the development of a software platform for hand held and mobile computing devices (known as Personal Digital Assistants: PDAs), which is employed by the visitors of cultural heritage sites.

The **NEMO** system allows the process and the presentation of content in real time based on the location of the visitor within the physical space, providing the following capabilities:

- Retrieval of Multimedia Exhibits
- Interactive tours in the site, both predefined and free tours, with embedded audio – video and textual information.
- Retrieval of information in different levels according to the time that visitor has for touring within the physical space.

The **NEMO** project includes also:

- The realization of both design and implementation study of the software and hardware architecture of the system, the detailed description of the tools and the different components that are needed as well as an installation study for the physical space.
- The realization of a tour plan for the visitor, in order to obtain a complete set of information for the site that is being visited thus ensuring the interactivity between the

user and the digital information provided and the continuous flow of information

- Digitization of the content according to the technical requirements posed by the requirements of **NEMO** platform.

In the context of the specific project a client-server architecture was developed, based on Java technology (J2ME) for mobile devices, which enabled the functionality of distributing multimedia content form the Server to the Clients of the system. The content was provided to the clients of the system based on the position of a specific the client in the space. The localization of the client was determined through the utilization of wireless network 802 11.g.



Figure 1: Actual snapshot from **NEMO** System

The specific installation, which has been already successfully completed in the Pieridis Museum in Larnaka is actually the

first, at least in European level, that has fully integrated the use of Location Based Services in the context of cultural heritage.



Figure 2: The introduction screen of the NEMO System at Pierides Museum

The project has been not only innovative in using existing technological capabilities, but it is also designed in such a way in order to be fully scalable to cover further functional requirements which could be introduced in the future, if the need arises.

The main advantage of the Nemo System lies in the creation of new means of content management and especially presentation of cultural heritage content, incorporating an intuitive and personalized manner, tailored to specific needs of each visitor.

1.2 General Objectives of the Project

The general objectives of the research project were:

1. The Exploitation of the possibilities that new technologies offer.
2. To provide new educational, instructive and recreational ways of presenting content (collections).
3. To Provide advanced services of information of cultural content.
4. To find new future use of the application from the Business Community.

1.3 Special Scientific and Technological Objectives

The special scientific and technological objectives of the research project were:

1. The presentation of information and knowledge with a friendly and ease of use approach.
2. The selection of more suitable technological solution for relevant applications.
3. The development of all relevant infrastructures.
4. The integration of modern technology for presenting cultural content.
5. To develop an application of techniques for the tracking in real time the movements of a user in an internal space, via a wireless network.

2. RESEARCH RESULTS

2.1 General

The Project is characterized by a high degree of scientific character and requires the harmonious coexistence of heterogeneous objectives and activities. The methodology that was adopted combines all the individual approaches in order to ensure the required level of presentation of content, technological solution, diffusion of results and further exploitation.

More specifically, during the development and implementation of the System, the Project Team worked under the following approaches:

1. Technological Approach
2. Spatial Approach
3. Museum Approach
4. Socio-economic Approach

2.2 Technological Approach

This Approach is divided into 3 distinct phases:

1. the planning and the implementation of the Server where the digitalised material will be stored,
2. the planning, the development and the implementation of the application that is installed in the device of the user, and finally
3. the completion of the software that is required for the computing the exact location of the user inside the museum physical space.

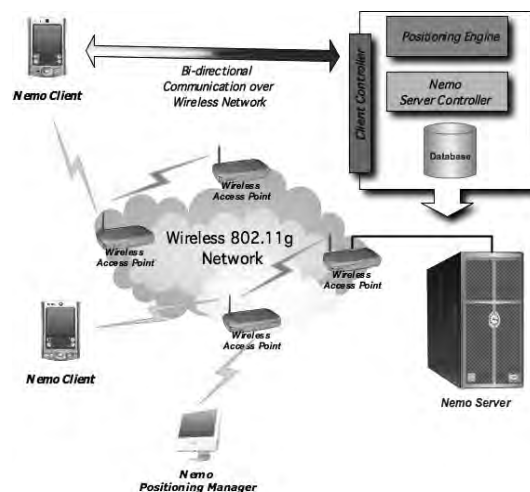

Figure 3: Technological Approach

In the context of the specific project a client-server architecture was developed, based on Java technology (J2ME) for mobile devices, which enabled the functionality of distributing multimedia content from the Server to the Clients of the system. The content was provided to the clients of the system based on the position of a specific the client in the space. The localization of the client was determined through the utilization of wireless network 802.11g. This innovative approach provided us with the exact localization of the client in 34 distinct locations within the physical area of the museum, with a precision varying from 0% to 0.3% position error, by utilizing

a set of 18 wireless antennas (including the redundant access points) and the same time providing simultaneously content to 4-5 clients (visitors).

The receptors were positioned in specific points of the museum, taking in consideration the architectural properties for each room of the museum and in such way as to maximise the strength of the wireless network.

At the same time, the museum drawings were digitalised and then installed at the handheld computers. There, a process of "their normalization" was applied, so that there is a complete identification between the coordinates of the architectural drawings with the coordinates that will be used by the wireless network. In such a way, the land-planning perception is created. After the necessary corrections, the software was integrated in the System.

2.3 Spatial Approach

The Spatial Approach refers to the secure performance and functionality of the system within the physical space, the safe keeping and storage of content and the protection of all hardware and peripherals.

The technology used for computing the "location" of a user in the internal space is based on a probabilistic concept, which enhances the advantages that result from decisions theory, probabilistic models and information theory.

The Spatial Approach describes the planning of arrangement of wireless appliances (access points) in the physical space, with the advantages and disadvantages of the various network topologies that were tried. This process is examined within the particular application, pioneered at the Pierides Museum.

Finally, the methods that were used for the improvement of output and precision of location software were presented and evaluated.

2.4 Socio-Economic Approach

The socio-economic effects from the use of mobile systems in presenting cultural content had a particular importance, both during the adoption of the script/Strategy Phase and later, when all the potential possibilities were being considered.

The Project Team, early decided that the system would have an instructive and promotional character concerning the cultural element, and at the same time, a commercial value in multiple application in terms of future growth.

The introduction of new technologies in the culture industry, according to European and international standards, creates new prospects and growth opportunities for relevant organisations and for the local economy. New scientists are focusing on new technologies and state-of-the art policies and are developing relevant applications in order to incorporate modern museum and educational tendencies in the museum community of Cyprus.

At the same time, in a country as Cyprus, where services and especially Tourist Services, constitute the most important productive area of creation of National Wealth, the use of modern technology for the presentation and projection of cultural characteristics it is considered henceforth necessary.

The NEMO System, on its own way, generates and enhances the competitiveness of the tourist product of Cyprus, something much needed in a highly adverse market.

NEMO System is not only **technologically innovative** but can also be **expanded immediately** (in terms of technological solution and content management) in commercial applications, contributing in the creation of a new approach in the management, projection and presentation of various "collections", in easy and individualized way. The location based information management System is very well suited for spotting products in large areas (e.g. shopping malls), and thus providing multiple information and increased customer focus.

2.5 Museum Approach

In this Approach, the script strategy of a conducted tour was developed, a tour which includes the ideological dimension of report, the proposed historical but also territorial ways with the special points of interest and the training of special list on the digitalisation of content.



Figure 4: Actual Screen from the application in the Pierides Museum

The various scripts/Strategies for touring the Museum, took into consideration the most advanced and state-of-the art educational methods for promoting cultural content.

At the same time, the creation of the digital multimedia material

was completed. In this stage, the digitalisation and digital treatment of the primary or other forms of content was realised, the adaptation and assiduity of this material was configured according to the exact specifications of the System, the translation and adaptation of was finalised in both English and Greek.

Finally the application was installed in the handheld devices (PDA's) and then it was "live" pilot tested in the Museum.

3. EVALUATION OF THE SYSTEM

The NEMO System, was firstly evaluated during the pilot period by both the visitors as well as from the employees of the Museum. In a period of one month, 150 people used the system, on a live basis. The tests were held in 3 different scenarios. 1. With the simultaneous use of five end-users, 2. With the simultaneous use of three end-users and 3. With the use of a sole end-user. The tests were held to calculate the accuracy of the signal in all occasions and the customer satisfaction rate. The accuracy of the signal turn to be accurate with a variance, ranging from 45cm up to 95 cm and not depending on the parallel use. As far as the satisfaction rates, the results were very positive especially in the cases of visitors ageing from 18-60. However, in ages, ranging above 60 years old, the comments were neutral to negative. More specifically, on average:

- 80% of the visitors evaluated these kind of technologies as useful or very useful.
- 60% of the visitors found the information provided as educational
- 70% of the visitors found the system as user friendly
- 40% of the visitors prefer navigating the museum with such a system
- 10% of the visitors prefer a combination of NEMO System and human navigation
- 30% of the visitors prefer human navigation
- 20% of the visitor do not want navigation
- 65% of the visitors were happy or very happy with the accuracy of the System
- 70% of the visitors suggested a quicker tracking response of the system (10-15 seconds is the time needed)

A second evaluation of the System was held by the technicians of the Cyprus Telecommunication Authority (CYTA). The test was held in the Museum, regarding: a. the accuracy of the tracking system and b: the response timing. The evaluation was held after the pilot period, and the results of the pilot program were taken into consideration. CYTA found the System as "very innovative" and "very accurate". As a result, CYTA financed the implementation in the Pierides Museum, and became the GRAND Sponsor of the research program.

The third evaluation, was held in the live presentation of the System, in a press conference in the Museum Pierides. Journalists from all the major TV channels, as well as the major newspapers of Cyprus were present, as well as representatives of the Cyprus Research Promotion Foundation to test the System. The results were very positive, with impressive media coverage.

4. IMPLEMENTATION TO OTHER MUSEUMS

The System NEMO, can be easily implemented to other Museums. The developed software platform, as well as the tracking software, can be applied in different spatial approaches, according to the building drawings. That means, certain information can be linked with specific spatial parameters as to track and show multimedia information accordingly. In every new spatial case (museum, archaeological area etc) the following actions have to be to done to implement NEMO:

1. Digitise content
2. Utilizing wireless antennas according to the building drawings and objects
3. Link specific objects / areas with specific digital content
4. Check accuracy
5. Calibration of the area
6. Fine Tuning Accuracy
7. Pilot test
8. Launch of the System

Up to now, two more museums in Greece have already agreed to implement the NEMO System as their main automated navigator.

5. REFERENCES

- Humbert J.M, 2003, Living in the Present: Museums and ICTs, *First International Workshop on Information Technologies (ICTs), Arts and Cultural Heritage*, Donostia-San Sebastian.
- Kalliaras P., Sotiriou A., Zoi S., Karigiannis J, Farandouris N., Mitrou N., 2004, *The AVATON Architecture: Location Based Multimedia Services for Tourists*, ITI 2nd International Conference on Information & Communication Technology "Multimedia Services and Underlying Network Infrastructure", Cairo Egypt.
- Karigiannis J., Vlahakis V., Daehne P., 2003, *ARCHEOGUIDE: Challenges and Solutions of a Personalized Augmented Reality Guide for Archeological Sites*, Computer Graphics in Art, History and Archeology. Special Issue of the IEEE Computer Graphics and Application Magazine.
- Schneider M., 2003, Innovative Mixed Reality applications in archaeological sites: the ARCHEOGUIDE project, *First International Workshop on Information Technologies (ICTs), Arts and Cultural Heritage*, Donostia-San Sebastian.
- Vlahakis V., Karigiannis J, Ioannidis N., 2003, *Augmented Reality Touring of Archeological Sites with the ARCHEOGUIDE System*, 9th Issue of Cultivate Interactive

THE INFLUENCE OF VIRTUAL ENVIRONMENT TECHNOLOGIES ON ESTIMATING OBJECT SIZES AND COLOURS

I. Heldal^{a,*}, L. Bråthe^b, B. Stahre^c, R. Schroeder^d, A. Steed^e

^a Chalmers University of Technology, Dept. of Technology Management and Economics, SE-41296 Göteborg, Sweden
– ilona.heldal@chalmers.se

^b Volvo Powertrain, SE-40508 Göteborg, Sweden – lars.brathe@volvo.com

^c Chalmers University of Technology, Dept. of Architecture, SE-41296 Göteborg, Sweden – bea@chalmers.se

^d University of Oxford, Oxford Internet Institute, OX1 3JS Oxford, – Ralph.Schroeder@oii.ox.ac.uk

^e UCL, Dept. of Computer Science, WC1E 6BT London, – A.Steed@cs.ucl.ac.uk

KEY WORDS: Virtual environments, Representations, Size, Colours, Estimations, Object focused work, Performance, Presence

ABSTRACT:

By using Virtual Environment technologies (VEs), complex models can be designed and developed, and their features visualized, simulated, discussed and documented. People can, however, experience the models of the same artefact differently depending on which VE technologies they are using, even if the representations are intended to give the same experiences. This paper explores how experiencing the sizes and colours of the virtual representations of an artefact is influenced by the chosen VE technology. We also examine how the differences in these estimations can relate to overall performance and experiences for object focused work. For size and colour estimations we examine further data from a previous experimental study, from where the analysis of overall performance and experiences are presented elsewhere. This paper illustrates significant differences between size estimations for models implemented to support the same or similar experiences in different VE technologies. The results argue for the benefits of using large-scale systems for better size estimations and that inhabiting the spaces with avatars contributes to more accurate estimations. The latter is especially important for smaller displays and single-user work. Visual cues and the social interaction in distributed systems, even simpler technologies, e.g. desktop VEs, can support more accurate size estimations. Using colour names can also support collaboration.

1. INTRODUCTION

Many projects in industry use Virtual Reality systems, or Virtual Environments (VEs), for their three-dimensional graphical, high-performance applications. A wide range of VE technologies is in use today, from everyday desktop systems to large-scale projection technologies. Some of them are used in single-user, others in collaborative, settings. In collaborative settings it is common that a technology or technical setting to which a person has access differs somewhat from the technology the person's partner is working with. There are several studies showing that different technologies have different impact on task performance (Tromp et al. 2003; Heldal, Schroeder et al. 2005; Wolff et al. 2007), which also has a great impact on experiencing creativity in innovative work (Roberts et al. 2006). Therefore, to build the same virtual models in the different VE technologies used in collaborative settings in such a way that these support collaborative work on equal premises is important.

In a large earlier experiment we compared overall work performance and experienced presence for eight different technical settings (Heldal et al. 2006). In the present paper we extend the study by also including perception of size. Reexamining the qualitative data we observed that we had many comments on colour perception throughout the whole study. We did not ask explicitly about experiencing colours, but it was noted to contribute to better perception of the objects (Billger et al. 2004). We mention here noted comments when they are appropriate.

The task examined was a relatively simple task, but complicated enough to give the impression of a real work scenario. Some of the results, e.g. that immersiveness and symmetry for the used technical environment have a great impact on task competition and experiences was already shown. Non-equal technologies on the different distributed sites were disturbing; even smaller differences can lead to disruptions in collaboration. However, if the collaborators become familiar with advantages or disadvantages of their partner's system, they can exploit it for their benefit (Heldal, Schroeder et al. 2005). These earlier results trigger further questions, e.g.: Does the different type of VE technologies used in a collaborative setting imply differences in size perceptions? Do the collaborative and single user estimations regarding object sizes differ for the same technologies? By reanalyzing data from the earlier experiment, this paper illustrates significant differences between size estimations. We do not have collected quantitative data on colour appearance from the beginning.

After the Introduction, Section 2 presents related research and some ideas on experiencing sizes in VEs. Section 3 summarizes the background experiment, a relatively simple puzzle-study that we used to obtain statistically significant data on comparing VE technologies. Section 4 presents new quantitative and qualitative results on appreciating sizes and colours, and examines these new results in relation to earlier findings about presence and performance. Section 5 is the Concluding Remarks, and Section 6 discusses future work.

* Corresponding author.

2. BACKGROUND

The impact of the technology used on the people involved and on the communication flow has been studied since the time when people begun to use computer-mediated communications, such as telephones or Internet (e.g. Kiesler et al. 1984). These studies showed that access to a technology and some application is necessary but not sufficient for fruitful distributed collaboration. The underlying content and a network of social and technical relationships have a great impact on the quality of work and experiences (Scott 1999; Walther 2007).

Since object focused tasks are quite typical, working with models is common at many workplaces; so the way people experience and estimate physical characteristics of the representations, and its impact on performance and experiences, are important (Hindmarsh et al. 1998; Heldal, Steed et al. 2005). Realistically experiencing representations of artefacts is connected with correctly estimating their physical characteristics, such as their physical sizes, their actual shapes and colours.

Realistically does not necessarily mean physical realism or naturalism. The aim of virtual reality systems is not necessarily to reproduce physical artefacts, or to achieve graphic realism (Stanney 2002), nor is it to reproduce natural interaction in these environments for all situations (Bowman 1999). In relation to correctly experiencing objects' sizes and dynamics, already Descartes wrote that one usually perceives an object "as being the same size regardless of its distance from the observer even though the retinal size of the object gets smaller with increasing distance from the observer" (Descartes 1637 – cited by Kenyon et al. 2008). Also perceiving objects with its shapes differs from the actual sizes even in physical environments.

To experience correctly the object representations in VEs, we need to know how our eyes are working, where the object is located in the environment, and several other data about the context and VE technology (Rolland et al. 1995). To benefit task competition can also be enough, to simulate less or to use abstractions (Stahre et al. 2008). The VE technology users need to know, however, how they can relate their visual experiences to the task they are working with. As an example: If the task is to experience the model for a new road in a virtual environment in order to discuss where and how the new road has to be built, the users should know how the used technology affects experiences (Heldal 2007).

In relation to size and distance perception in VEs there is a significant amount of work (e.g. Ellis and Menges 1997; Plumert et al. 2004; S ik-L anyi et al. 2005; Interrante et al. 2006). Many previous studies explore the influence of the size of the output display technologies on task performance and experiences. For head-mounted display technologies, Arthur (2000) reviews the effects of FOV on task performance. The large FOV in immersive environments (Slater et al. 2000; IJsselstein et al. 2001) and in general the large panoramic displays (Dudfield 2001; Sonnenwald 2002) also contribute to better experiences. Tan showed that large screens are better for 3D orientation as well as for improved performance of spatial tasks (Tan 2006). Burgee (2005) showed that a large screen can be used with better accuracy for handling hypertext in a browser. Distances in real environments are considered to be compressed in comparison with immersive environments (Interrante et al. 2006). How accuracy for adaptive menus can be correlated with screen sizes was recently examined by

Findlater and McGrenere (2008). For better learning about new features and higher satisfaction, they argue for controlled screen estates.

Today, we often are employing knowledge of perspective and treating sizes in relation to display sizes and the sizes of actual graphical representations. One may think that we should already know how to represent graphical artefacts believable for all users, just by doing measurements and calculating how the sizes and shapes have to be translated for the different technologies. This is not yet the case. According to Kenyon et al. (2008), in the VEs of today, displaying more complex scenes with correct cues would require too much effort and time.

3. THE PUZZLE STUDIES

The experiment presented in this study has followed a large earlier experiment that compared effectiveness and experiences of work in eight settings: single-user work in three different settings and collaboration in five settings. Table 1 and Section 3.2 include these settings and their abbreviations, while a more complete description can be found in Heldal et al. (2006).

The Settings Used	
Single user in the IPT	I
Single user working on a Desktop	D
Single user with cardboard boxes	R
Gothenburg IPT and London IPT	I—I
IPT connected to HMD	I—HMD
IPT connected to Desktop system	I—D
Two connected Desktop systems	D—D
Cardboard blocks	R—R

Table 1: Settings and abbreviations used

The data were collected from 286 voluntary participants, all first-time users working on a relatively easy object-focused task. For each condition, a maximum of 20 minutes was given to solve the puzzle. The participants were asked to fill out a questionnaire on their background before the trial and on their individual experiences (with approximately 22 questions) after the trial. The qualitative questions were about experiences and performance, benefits and hindrances during task-solving. Quotations from these answers are given to exemplify opinions. Additionally, an observer filled out observation sheets for each of the subjects.

3.1 The Task

The task is about solving a puzzle by rearranging a few objects. For this purpose, active interaction is needed; the subjects had to move around, turn, examine, and relocate objects. Assembling and disassembling are quite typical activities. One of the main benefits of full-scale physical models is to have objects that can be grabbed and physically examined. One of the challenges of VE technologies is to replace full-scale physical models. Therefore we chose the actual size of the cubes to be big enough so they could be grabbed both in physical and in VEs. The task is easier than solving an original

Rubik cube, but difficult enough to engage the subjects and make them work for a few minutes. The puzzle involved 8 separate blocks with different colours on different sides.



Figure 2: A screen shot on two participants solving the puzzle.

The pairs had to rearrange the blocks so that each side would display a single colour, i.e. 4 squares of the same colour on each of the six sides (see Figure 2). The task was similar to, but less complex than, the popular Rubik's cube puzzle that involves 27 blocks with 9 squares on each side. The squares were 30 cm along each edge, both in reality and in VEs.

3.2 The Technologies Used

The virtual models were implemented as similarly as possible in the different VEs. For the R trial, participants were asked to do the task with cardboard blocks having the same size and colours as the blocks that were represented in the VEs. The single-user settings were: a room where the participant was working with physical objects, an immersive virtual environment – such as the CAVE™ (here: IPT) originally described by Cruz (Cruz et al., 1993) – and desktop systems. Adjustments were made so that the environments were similar in appearance and functionality.

For the collaborative trials we used the same VEs as for the single-user trials, in different combinations connected through the Internet. Additionally, to have asymmetrical *immersive* setting we used a head-mounted display (HMD) technology. For the collaborative settings, the participants could talk to and hear each other using a wired headset with microphone as well as earphones. In these settings each partner was portrayed to the others by the use of a simple avatar with a jointed arm. In the immersive systems used, the participants could grab the blocks or cubes by putting their hand into the virtual cube and pressing on the button of the 3-D wand in the case of the IPTs, and by pinching together their thumb and index finger using the glove for the HMD. On the desktop system, participants could navigate by moving the middle mouse button and could select the cubes by clicking on a cube with the left mouse button. To move the cubes, they had to keep the right mouse button pressed and move the mouse in the desired direction. They could also rotate the cubes by pressing the right mouse button combined with the shift key.

3.3 Earlier Results

Earlier results showed correlation between experiences, performance and immersiveness of the technology (see Heldal et al. 2005; Heldal et al. 2006).

Presence: Presence is an important factor in the experience of an environment. It is defined as the sense of being in a computer-generated place other than that in which one is physically present (Slater and Steed 2000). Individuals working in distributed immersive environments felt more present, and experienced work as more enjoyable, than those in non-immersive settings. The findings demonstrated the benefits of using immersive technologies for “better seeing” the objects and higher presence. Distributed immersive environments were experienced nearly the same as being there together in physical space. For asymmetrical settings, even if not statistically significant, the collaboration with a “more immersive” technology increased one’s presence. However, in relation to experienced presence, the pairs always evaluated higher presence in the immersive environments.

Performance: In relation to performance and presence for single users, the R environments were estimated to be superior. Presence was correlated with performance and technology for single users, and for the symmetrical collaborative settings. The findings also demonstrated the practical advantages of using symmetrical settings even if they are non-immersive ones. Social interaction was also considered to be a facilitator for obtaining better results.

3.4 Estimating Sizes

The new data on experiencing sizes come from these earlier experiments. These are data on size estimations and qualitative comments on size and colours from the 286 first-time users: 22 individuals for three single-user setting and 22 pairs for five collaborative setting. Since colours were not calibrated accurately in the different VEs, we only consider subjective comments on colours, their content and occurrences.

The sizes were estimated quantitatively in all eight different settings. People answered the question: “How large do you estimate that the sides of the cubes were (all sides of the cubes were the same length)?” Since there was some very extreme estimation for sizes, we choose here for each case to exclude the two lowest and the two highest of the 22 estimations, e.g. we present the average estimations of the middle 82% of users. Since we got a large spread in the data we removed two points on each side (the most extreme guesses) not to have the entire distribution disturbed by one single measurement point being totally way off (outlier). To remove 2 points on each side - it's a bit unusual, but nevertheless in line with practice, since we are still almost taking the “mean”, but we've taken a small step towards the “median”. As the spread is considerable it is not meaningful to use the normal distribution and hence the standard deviation as it is. This has to do with the fact that some are estimating sizes more than twice the mean and as none are guessing for negative sizes, this directly implies that the distribution would be skew, and then standard deviation is not correct.

4. RESULTS

4.1 Single Users

Here we present the average estimations of the middle 82% of users (see e.g. Figure 3). Both for the R condition and the immersive VE people experienced the sizes somewhat larger than they actually were. As the figure shows only the users working with the desktop system estimated the cube size much lower than the real sizes. (The D users estimations is 9.14 cm, while the I users estimation is 32.94 cm and the R's is 30.7cm).

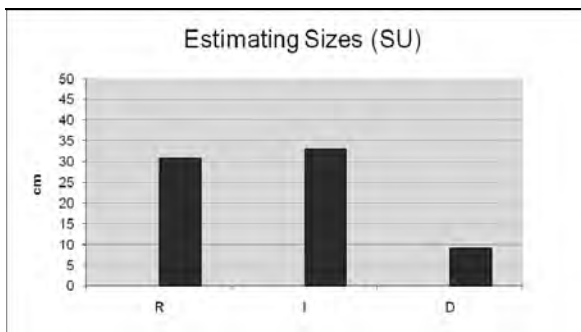

Figure 3: How the most representative users experienced sizes when working with physical models (R) and virtual models (Cave-type: I, and on desktop). Correct size is $30 \times 30 \times 30 \text{ cm}^3$.

Regarding expectations, one user in the R setting wrote: “For these [large?] boxes a glass table would be very useful; my first impression was that I wanted a pencil and paper to take notes, but that was not necessary by the end.” The relatively large sizes of the cardboard boxes allowed a subject to move a box only with two hands. Two subjects mentioned the adequate sizes, e.g. one wrote: “[I liked] the large boxes that have ergonomically sizes for my arms, that they were light-weight and have funny colours”, while another wrote that “[it was] quite fun to play with big size cubes and colours.” For the desktop systems many participants complained about certain characteristics of the VEs, from the too small screen sizes and the noises generated to various poor functionalities. One mentioned: “I spent a lot of energy to keep me inside within the screen”. The participants in the D setting also expected to have a virtual reality experience and missed the insider’s view they are used with games: “I liked it when I moved around, even if I missed the natural, realistic experience for this application and its functionalities.”

For the IPT systems mentioned seven users did experience problems because of light conditions and how they could see the objects, while four more people mentioned “not enough clear colours” explicitly. However, some other users mentioned that they experienced the “soft lights” in the IPT positively. For the R setting we also received a few comments on negative experiences in problem-solving caused by the bad lighting conditions. Two individuals experienced problems in differentiating properly between the green and blue colours for R settings, while for the IPT it was difficult to distinguish orange and red. But the lighting was not only a hindrance; for both the IPT and the R settings, there were participants who mentioned it as a positive experience that helped them to relax and concentrate on solving the problem.

Throughout the single-user studies, the participants commonly complained of missing sound experiences. Some (7 participants,

3 from the IPT) even mentioned the pleasant VE experience and lacking “corresponding” sound experiences. In the IPT the participants did not complain of disturbing noises. Among the negative comments there were a few participants who complained about disturbing sounds outside the real room (3 for the R trial, but 10 for the D settings). The participants in the D settings mentioned disturbing noises coming from many different locations (from the computer, inside the room, outside the room, knocking, talking experiment leaders, etc.).

4.2 Collaborative Work

How people estimate sizes for collaborative work is presented in Figure 4. Accordingly, there were no underestimations for the $30 \times 30 \times 30 \text{ cm}^3$ cubes.

There were not so many qualitative comments relating to the sizes of the cubes in the collaborative settings. The observation lists also show, however, that pairs in the networked settings communicated with each other by using the names of the colours. For example, in the I-D setting (and the same was observed in the I-HMD setting too), when the subjects sitting with the desktop system observed that it was easier to ask their partners about the colours of the hidden side of the cubes, rather than to manipulate the cubes themselves in order to see the colours, they did ask. Thus a pair would move their avatars in such a way as to face each other and have the model between them, making it easier to collaborate. Social coordination thus “saved” unnecessary manipulative activities, without the participants being aware of this and reporting it as an important feature of their collaboration. For the I-HMD and I-D settings, the participants in the HMD, D settings were more passive. In response to an open-ended question, the person who wore the HMD commented: “He [the partner in the IPT system] did most of the checking [of the colours on the cubes]. He found the right cubes and I placed them.”

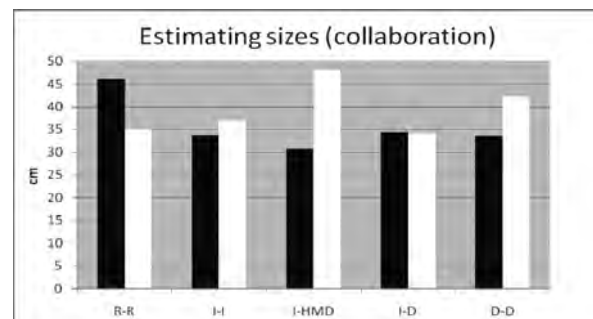

Figure 4: How the most representative individuals experienced sizes when collaborating in pairs with real objects R-R and in the four networked settings: I-I, I-HMD, I-D, D-D. Correct size is $30 \times 30 \times 30 \text{ cm}^3$.

For the collaborative settings, no individuals working with the real objects mentioned explicitly that handling the colours was problematic. Colours were mentioned in relation to problem-solving (e.g. “I didn’t observe that other colours than black can be inside in the Rubik cube.”). There were 6 participants who found it hard to distinguish certain colours in the I-I settings (all from Göteborg); for the I-HMD setting 4 IPT users and 14 HMD complained, while for the I-D settings 9 IPT users and no desktop system users complained. There were only 2 complaints about colours from the desktop system users in the D-D setting. Unfortunately, many of these results can be

explained by the differences between the projectors used, updating frequencies, etc.

4.3 Analysis

We showed that sizes were overestimated in immersive single-user environments, and also when working with the R settings. If we do not consider the HMD technology, for the real setting and the immersive setting, the estimations were much more accurate than the estimations by the participants working with the desktop systems. Of course these results may be task-dependent (the type of task here was concrete, challenging, solvable, and quite short). To accurately estimate sizes can also be correlated with experienced presence. Presence was estimated to be much higher in the immersive environments (IPT, HMD) than in the non-immersive ones (according to many other studies that showed the same correlation; see in Haldal, 2006).

One of the interesting observations in this study is that people estimate sizes differently if they are working in pairs. This may be caused by discussions, choosing other reference objects, and also relating to the representations of others (the avatars). This finding also shows how important it is to populate certain models. While the actual size of a cardboard cube on the desktop system (if an outsider measured it with a ruler) was slightly above 2 cm, due to the experienced presence the single users estimated it as 25 cm and the collaborated pairs above the real size of 30 (between 33 and 42) cm, depending on the applied settings. When people collaborate with real objects, estimating sizes becomes less accurate than for single users. The differences between the estimations made after working with the real objects and after working in immersive IPT environments are not so peculiar, as shown in the previous section.

We thought that people who learn that their own experiences are more limited than their partner's are going to speak about differences, such as differences in experiencing objects, sizes, colours etc. From the observation lists, one can see that people not only spoke about these differences during task-solving, but also used benefits and hindrances in a way that favoured task-solving. However, they did not care about the differences after they solved (or failed to solve) the tasks. There were not more negative comments in relation to experiencing sizes in the collaborative, non-symmetrical conditions.

According to the observations and remarks the best reference for estimating sizes is the size of the human body, which is shown by a previous study as well (Haldal, Steed 2005).

5. CONCLUDING REMARKS

This paper shows the superiority of using large-scale systems for correctly estimating sizes by single users, especially for applications that do not contain intuitive references, such as avatars. In collaborative settings the estimations made by pairs working with desktop systems were equally good, but this can also depend on the presence of the representation of the other person, the size of her/his body (previously discussed by Haldal, Steed et al., 2005). Moreover, we showed how working in pairs does influence experienced sizes. This is an additional remark to several other studies before (e.g. Scott, 1999, Haldal, Steed et al., 2005, Walther, 2007) that mentioned the

implications of technology for different aspects of distributed collaboration – performance, presence, the use of language etc.

The results also argue that people are better at estimating object sizes in distributed settings, since the deviation between the extreme low or high estimations was less in the collaborative settings throughout the entire study. Again, this may be a result of avatar representation in the distributed settings, but also of using a relatively scaled environment only with the most necessary artefacts. It is interesting to note the correlation of immersiveness not only to accurate size estimations, but as shown earlier also to performance and collaborative experiences.

Regarding colour representation, this study could not distinguish any technology as superior, although it highlighted diverse effects, for example, the influence of applying soft lighting on users both in immersive environments and in real, full-scale models. Soft lighting conditions can increase the presence of certain users, yet disturb others – according to the subjective comments. Therefore, allowing adjustable lighting for the actual users in future VEs may contribute to higher experiences and better performance.

6. FUTURE WORK

There are at least three major paths for extending this work:

Firstly, to analyze what effect the improvements in graphical technology have on *experiencing* graphical VE models more realistically in comparison with experiencing physical models for several concrete artefacts. We need answers to questions like: Do such improvements benefit exchanging physical models for graphical ones in industry? – and in which industry? How does exchange depend on certain characteristics of the artefact that needs to be modelled? What can we gain and what can we lose in this process?

A second path is to utilize new possibilities that have become available since the initial tests were carried out. For example, to further examine the single-user and collaborative work in new technologies and use these results as possibilities for improvements. This path also includes research on how colouring, lighting and sound the surroundings can influence experiencing and estimating object characteristics and helping users to use visual cues to support social interaction.

The third path is to examine how strictly the symmetry conditions need to be applied. What are the consequences and if the networked conditions are more symmetric – e.g. if people use desktop systems but only the screens vary from some small to larger size, e.g. from a currently quite typical 19 inches to 40?

Examining qualitative comments also points to the importance of using appropriate colours and light conditions, where appropriate means rather usable for the given task than photorealistic. Further studies are needed to demonstrate this assumption, since this study was not focused on colour examination. Furthermore, additional work is needed to understand how well our results can be generalized for more complex tasks and for larger user groups.

7. REFERENCES

References from Journals:

Ellis S. R. and Menges B. M., 1997. Judgments of the distance to nearby virtual objects: Interaction of viewing conditions and accommodative demand. *Presence: Teleoperators and Virtual Environments*, 6(4), pp. 452-460.

Heldal I., Steed A., et al., 2005. Successes and failures in copresent situations. *Presence: Teleoperators and Virtual Environments*, MIT Press, 14(5), pp. 563-569.

IJsselsteijn W. et al., 2001. Effects of stereoscopic presentation, image motion, and screen size on subjective and objective corroborative measures of presence. *Presence: Teleoperators and Virtual Environments*, 10(3), pp. 298-311.

Kenyon et al., 2008. Accommodation and size-constancy of virtual objects. *Annals of Biomedical Engineering*, 36(2), pp. 342-348.

Kiesler S., Siegel J., and McGuire T. W., 1984. Social psychological aspects of computer mediated communication. *American Psychologist*, 39, pp. 1123-1134.

Roberts D., et al., 2006. Factors influencing flow of object focused collaboration in collaborative virtual environments. *Journal of Virtual Reality*, 10, pp. 119-133.

Rolland J. P., Gibson W., and Ariely D., 1995. Towards quantifying depth and size perception in virtual environments. *Presence: Teleoperators and Virtual Environment*, 4, pp. 24-29.

Sík-Lányi C. Et al., 2003. Using virtual environments to improve space and depth perception. *Journal of Information Technology Education*, 2, pp. 291-303.

Slater, M. and Steed, A., 2000. A virtual presence counter. In *Presence Teleoperators and Virtual Environments*, MIT Press, 9(5), pp. 413-434.

Tan, D.S. et al., 2006. Physically large displays improve performance on spatial tasks. *ACM Transactions on Computer-Human Interaction*, 13(1), pp. 71-99.

Tromp, J., Steed, A. and Wilson, J., 2003. Systematic usability evaluation and design issues for collaborative virtual environments. *Presence: Teleoperators and Virtual Environments*. 10(3), pp. 241-67.

Walther, J. B., 2007. Selective self-presentation in computer-mediated communication: Hyperpersonal dimensions of technology, language, and cognition. *Computers in Human Behavior*, 23, pp. 2538-2557.

Wolff R., et al., 2007. A review of telecollaboration technologies with respect to closely coupled collaboration. *International Journal of Computer Applications in Technology* 29(1), pp. 19-26.

References from Books:

Arthur K. W., 2000. *Effects of Field of View on Performance with Head-Mounted Displays*. PhD Thesis, University of North Carolina, Chapel Hill, NC.

Bowman, D. A., 1999. *Interaction Techniques for Common Tasks in Immersive Virtual Environments*. PhD Thesis, Georgia Institute of Technology.

Burgee, L. E., 2005. *The Effects of Screen Size, Information Organization, and Time on User Comprehension of Text-Based Information Presented in a Web Browser*. PhD Thesis, Department of Information Systems, University of Maryland.

Scott, C.R., 1999. Communication technology and group communication. In Frey L. R. (ed.): *The Handbook of Group Communication Theory and Research*. Sage, pp. 431-472.

Sonnenwald, D. H. et al., 2002. Collaboration in the large: Using Video Conferencing to Facilitate Large Group Interaction. In Khalil, A. G. (ed.), *Knowledge and Information Technology in 21st Century Organizations: Human and Social Perspectives*. Idea Publishing Co., Hershey, pp. 136-55.

Stanney K. M., 2002. *Handbook of Virtual Environments. Design, Implementation, and Applications*. Lawrence Erlbaum Associates, London.

References from Other Literature:

Billger M. et al., 2004. Perception of color and space in virtual reality: a comparison between real room and virtual reality models. *Proc. Human Vision and Electronic Imaging IX*, pp. 90-98.

Cruz-Neira C., Sandin D., and DeFanti T., 1993. Surround-screen projection-based virtual reality: The design and implementation of the CAVE. *Proc. of SIGGRAPH'93*, pp. 135-142.

Dudfield, H.J. et al., 2001. Big is better? Human factors issues of large screen displays with military command teams. *Proc. IEEE Human Interfaces in Control Rooms, Cockpits and Command Centres*, pp. 304-309.

Findlater, L., McGrenere, J., 2008. Impact of screen size on performance, awareness, and user satisfaction with adaptive graphical user interfaces. *Proc. of CHI'08*, ACM Press, pp. 1247-1256.

Heldal, I., Schroeder, R., et al., 2005. Immersiveness and symmetry in copresent scenarios. *Proc. of IEEE VR'05, Bonn*, pp. 171-178.

Heldal I., Spante M., and Connell M., 2006. Are two heads better than one? Object-focused collaboration in distributed virtual environments. *Proc. of VRST'06*, pp. 287-296.

Hindmarsh, et al., 1998. Fragmented interaction: Establishing mutual orientation in virtual environments. *Proc. of CSCW'98*, pp. 217-26.

Interrante V., Anderson L., and Ries B., 2006. Distance perception in immersive virtual environments, revisited. *Proc. IEEEVR '06*, pp. 3-10.

Plumert J.M. et al., 2004. Distance perception in real and virtual environments. *Proc. of the 1st Symposium on Applied Perception in Graphics and Visualization*, pp. 27-34.

Stahre B., von Raalte S., and Heldal I., 2008. Sketching techniques in virtual reality: Evaluation of texturing styles in an urban planning model. *Forthcoming in the proc. of VSMM'08*.

E-MAPPING THE HISTORY OF TRANSPORT IN A PORT CITY IN SOUTH AFRICA

P. C. Liebetrau

DISA: Digital Innovation South Africa, University of KwaZulu-Natal, King George V Avenue, Durban, South Africa -
liebetrau@ukzn.ac.za

KEY WORDS: Digital projects, Open source software, South Africa, Transport, Cultural heritage, Collaboration, Greenstone digital library software, Open access

ABSTRACT:

Durban, a port city on the east coast of South Africa has an interesting history as a colonial city occupying an important place in the trade and commercial history of South Africa. Rapid urbanisation has however changed the face of the city which now has a multicultural population of around 3 million inhabitants. As we enter the twenty-first century, and with the twentieth century a rapidly fading or non-existent memory for a large part of the population, it is an important task, in terms of cultural heritage, to capture the essence of its being as a city, historically, for education, training and research purposes. A project entitled *Durban in Motion: a virtual exhibition and digital archive* (<http://www.disa.ukzn.ac.za/DIM/slideshow>) was conceived with such a purpose in mind and was developed into a small but multidisciplinary digital project, mapping of the history of transport in Durban. A selection of photographs, all in the public domain, and housed in local museums and archives, was the starting point for the project and which grew to become a multimedia collaboration involving academics, historians, photographers, IT technicians, librarians and archivists. Developed using open source software, open standards and enjoying open web access, the project presented an opportunity to examine possibilities for the recording of histories in a cultural heritage context, using digital technologies, in a manner that is cost effective, easily achievable and enables inter-disciplinary collaboration with an openness of attitude. This are essential requirements for recording of cultural heritage histories in an African context where the limitations of funding for digitisation impacts on harnessing the power of the worldwide web to record and make available for research the incredibly rich and diverse cultural heritage of Africa.

1. INTRODUCTION

Digital technologies present opportunities for new ways of presenting the archive enabling new interpretations of cultural history in any given time. These opportunities, however, are reliant to a large extent on skills in information technology, internet bandwidth considerations, access to computers and servers, human capacity and funds. DISA: Digital Innovation South Africa (<http://www.disa.ukzn.ac.za>) is an initiative, based at the University of KwaZulu-Natal, South Africa, with a core function of using digital technologies to provide online resources in support of scholarly communication, research and teaching. The principles of open access, open source and open content underpin the development of capacity building and skills training. DISA is committed to finding ways to overcome barriers, in an African context, such as cost of proprietary software, advanced information technology skills, institutional capacity and bandwidth issues, in the utilisation of digital technologies. This requires exploration of alternative avenues to arrive at innovative, lightweight solutions that are practical, relatively simple to implement. These efforts are essential in bridging the widening digital gap between the wired northern and not-wired southern hemispheres, and within Africa itself.

A pilot project entitled *Durban in Motion: A virtual exhibition and digital archive* (<http://www.disa.ukzn.ac.za/DIM/slideshow>) was conceived and developed with such a purpose in mind. This small but multidisciplinary project was able to demonstrate the possibilities presented by collaborative efforts, the use of open source software and most importantly bringing an openness of attitude. From an initial seed of thought, discussions revolved around ways to reflect the “digital moment” using photographic resources and aimed at preservation and promotion of local cultural heritage. This led to the idea of electronically mapping (e-mapping) the history of

transport in Durban, to make it available on the World Wide Web. The concept provided a means of exploring synergies between the work and ideas of internationally acclaimed South African photographer and photojournalist, Paul Weinberg, with the aims of DISA. Collaboration was extended to include specialists in information technology, library, museum and archive information management, historians and other photographers.

2. BACKGROUND

Durban is a busy port city on the east coast of South Africa, serving as a gateway to the road and rail transport system to the interior of the country as well as frontline countries to the north and north west of its borders. In the early part of the twentieth century Durban’s development as a colonial city, was clearly reflected in styles of architecture, in dress codes, in modes of transport and others. A hundred years later, and the city has developed into a thriving multicultural commercial and industrial African city, with a population of around 3 million inhabitants. The local museums and archives in Durban hold rich resources about our local history. These resources are heavily consulted and used by researchers on a daily basis, resulting in deterioration of their physical condition. Furthermore the climatic conditions of hot and humid weather in Durban, as indeed in other parts of Africa, are not favourable to preservation of archival resources without climate control. Long term preservation of our cultural heritage resources in this environment is challenging and threatening long term access by researchers and other users.

In South Africa a new history curriculum is being introduced throughout all levels of education. This early period of our local history as evidenced by physical resources such as photographs and other archival documents provides a rich and varied

resource. They moreover provide a context against which to refigure the archive and provide new insights into our past history.

Digital technologies are able to play an important part in not only helping to preserve such heritage materials but at the same time enabling the presentation of these resources in new and exciting ways to support new teaching and learning methods, such as outcomes based education.

Durban in Motion, as a pilot project, was planned as a collaborative venture to explore ways in which to utilise digital technologies to revisit these archival resources, draw together resources and present them with a fresh perspective in a manner that requires relatively little capital, information technology knowledge expertise and skill. Open international standards and *de facto* web standards such as XML are important ways to facilitate global collaboration and exchange of data – all important considerations in building digital resources suitable for an African context.

3. RESEARCH PROCESS

DISA has been at the forefront in South Africa in implementing digitisation to provide online resources and in so doing has increased capacity in the area of digital technologies and contributes to re-skilling and new skills development in South Africa and further north in parts of Africa. DISA is funded by the Andrew Mellon Foundation, (<http://www.mellon.org>) as part of their worldwide support for building capacity in libraries using digital technologies and development of open source software solutions for the development of digital libraries and digital content supporting scholarly research.

Paul Weinberg is a highly respected South African photographer well known for his human and environmental photography from South Africa and other countries in Africa such as Namibia and Kenya (<http://www.paulweinberg.co.za/index.html>) His interest is in using photographic documentaries in telling stories of human interest while reflecting on social and economic human life realities. His photographs present an important aspect of the creative use of digital technology in reflecting and understanding our culture while supporting a creative approach to the research process.

As a DISA-led initiative, an initial workshop was convened with participants from South African Universities, heritage institutions, Paul Weinberg and representatives from DISA. Creative discussions at this workshop sowed the seed for the planning of a virtual exhibition and digital archive, using the theme of transport.

A selection of physical photographs, largely in the public domain and with no copyright restrictions, housed in the Durban Local History Museum, Campbell Collections Museum and Archive, the McCarthy Retail archives and from Paul Weinberg's personal archive, was the physical starting point. Focusing on several modes of transport, it was envisaged that the history of transport would be mapped through a narrative linking the photographs in themed contexts. These themes included Railroads, Early transport, Public transport, Private transport, Durban by air and others. The selection criteria included novelty, educational usefulness and aesthetic considerations.

Research was undertaken by an eminent economic historian from the University of KwaZulu-Natal, Durban campus, Professor Bill Freund, to place the photographs in an intellectual framework and context by providing a text-based historical narrative. This narrative formed the mapping link, threading information through and between the themes, pulling them together as a cohesive whole. Mapping introduced an important aspect of online resources, namely provision of context. In a physical archival setting, resources within collections are maintained within their context as part of the archival principal of sorting and organising material. In selecting materials from these collections, the context may be at risk of being lost. An online digital archive collection therefore requires careful attention to maintaining the context from within several collections and at the same time to the context of a greater whole.

As part of the multimedia approach to the project, original sound clips were included to provide another dimension of interest and authenticity, particularly important in a classroom and educational setting. Oral interviews were conducted and included as personal narratives.

The electronic mapping (e-mapping) of the diverse aspects of the project can be allied to the way that authors map the history of cities by providing references to times, places and people. Barbara Trapido, for instance, achieved this in a superb manner in her book *Frankie and Stankie*. Set in apartheid South Africa during the 1950's and 1960's it gives the reader a clear picture of the experience of growing up in Durban during this time. The history of Durban is interwoven, or mapped, through a story line narrative, largely autobiographical, placing events in a context of understanding for that period, in that place.

4. TECHNICAL PROCESS

4.1 Scanning

The selected photographs were scanned at internationally accepted archival standards. These were kept as archive masters with smaller file sized derivatives created for serving on the website. This is an important consideration when narrow bandwidth restricts access to large files. Local students from the University campus were trained and skilled in scanning.

4.2 Open source and open standards

The descriptive metadata was created in eXtensible Markup Language (XML) using the Dublin Core (DC) metadata element set. The metadata was created by student assistants from the department of Digital Media at UKZN, as part of the capacity building approach. The decision to engage student assistants again proved the DISA experience that input of metadata requires a high level of skill, not only in the use of digital technologies but also in attention to input detail and correct spelling which is often sadly lacking in student output based on payment for deliverables. This is however, balanced to a certain extent, by the ability of local students to bring their own indigenous historical knowledge to enrich the context of the photographs. Quality assurance was performed by librarians and archivists to ensure accuracy and authenticity of the metadata. This approach does necessitate a large increase in the time devoted to quality assurance, often overlooked in deciding on time lines and production targets but incorporates a balanced approach to building the intellectual content on the site.

The DC title and description elements are used as headers and explanations to introduce each photograph, enabling some pertinent information to be supplied while requiring minimal online reading. The full metadata, created in Greenstone open source software is used for the search and browse functionality and integrated into the site itself.

A drawback in using this approach is the customisation required to integrate Greenstone functionality into the website without the tell-tale Greenstone search and browse “look and feel”. The level of IT expertise to customise Greenstone is a consideration which may prove to be a stumbling block to the large scale implementation of Greenstone in an African context. That said, Greenstone is very useful in being able to provide a ready made vehicle for the creation of digital content for delivery on the World Wide Web, having a powerful integrated search and browse functionality to alleviate the need for extensive (and expensive) programming.

4.3 The website

The design of the website was based on Hypertext Markup Language (HTML) and designed to be simple, functional and user friendly. The design concept was based on a slide show, where each theme is a self contained show and runs on timed settings, which may be manually fast forwarded if required by an impatient user. The photographic approach of using greyscale to emphasise the subject material and increase impact was used on the website. The choice of utilising shades of grey is also used as a means to bring together the black and white photographs and harmonise the site as a whole. Inexpensive Macromedia Flash Creator was purchased for a fairly nominal fee to facilitate the slide show and is the only proprietary software underpinning the web site. The website, as a whole, is integrated into the DISA open source web system using Apache.

5. PROJECT MANAGEMENT

The project was co-ordinated and managed by the DISA Project Manager, who at that time was Dr Dale Peters. The management presented several challenges. Running on a very tight production schedule meant that the initial academic research process had to be slotted into and between other academic activities on campus often resulting in over run deadlines. A small budget dictated the employment of student assistants rather than qualified information managers for the creation of metadata which necessitated quality assurance to ensure consistently high standards and this incurred time delays and extra costs and was overlooked until relatively late in the project.

The project was fortunate in having a multiskilled IT specialist who has gained considerable experience, while working with DISA, in IT requirements specifically for digital libraries and archives. The expertise required for the bringing together of information content while creating user friendly web presentation and functionality is not to be under rated. This component is often challenging but essential. In an African context, this area provides special consideration in the absence of required skills. Greenstone software does provide the answer to some of these requirements but still relies heavily on skills for customisation.

One of the most challenging aspects of management proved to be the nurturing of creative talents and research processes within a tight production schedule. Experience within DISA has

shown this to be the case in other related projects and to which a solution has yet to be discovered.

However, as a pilot project, these challenges in themselves provide a learning opportunity for all members of the team and valuable lessons learned can be applied in subsequent projects, as a way of building on experiences and shortening the learning curves.

6. FUTURE DEVELOPMENT

Alongside hi-tech research and development is always the call for lightweight all-in-one solutions. Several software suites exist for all-in-one solutions. D-Space (<http://www.dspace.org/>), for instance, enables institutions to develop and maintain their own Institutional Repositories. Fedora (<http://www.fedora.org/>) enables management of complex Digital Library Content. In a similar but less sophisticated way Greenstone (<http://www.greenstone.org>) facilitates the development of digital library collections. These software suites lower the entry bar to many institutions that would otherwise not have the capacity to develop their own solutions.

A similar digital-library-in-a-box solution is required for management and innovative presentation of cultural heritage resources. An integrated multimedia approach would facilitate application in a variety of instances. The essential requirements would include open source software requiring relatively low IT skills for implementation but with flexible customisation options to encourage and enable individualised branding.

7. CONCLUSION

Development of the *Durban in Motion* project took just over a year, from the beginning of 2007, to the launch in early March 2008. It was well received and publicised in the local press. As a part of the University of KwaZulu-Natal, whose mission is to become the premier South African university of African scholarship, this project was able to demonstrate success. While it does not provide an all-in-one solution it does provide a vision for development based on open source software, open international and *de facto* standards and working in a collaborative networked environment. It is also possible, on a relatively small budget, to achieve success in the use of digital technologies to support the development and innovative dissemination of (cultural heritage) resources for scholarly and educational research and teaching using the World Wide Web.

However, it must be acknowledged, that the major success may only be realised when the lessons learned from this project can be utilised in finding solutions to truly harness the power of digital technologies for application in Africa.

8. SELECTED BIBLIOGRAPHY

Peters, D.P. and P.C. Liebetrau. 2003. Tails of the Zulu Worriers: the digital representation of cultural heritage. Paper presented at the Digital Resources in Humanities Conference, University of Gloucestershire, U.K.

Hamilton, Carolyn, Verne Harris, Jane Taylor (eds). 2002. *Refiguring the Archive*. Cape Town: David Philip

Trapido, B. 2004. *Frankie and Stankie*. London: Bloomsbury.

9. ACKNOWLEDGEMENTS

This project would not have been possible without the financial assistance of the McCarthy Retail Group and the Anglo American Chairman's Fund.

TEACHING “HI-tech-Story”: A WEBQUEST FOR HIGHER ORDER THINKING SKILLS

A.G. Vandarakis^a, K.M. Staral^b and S. J. Noel^c

Ogden Elementary School, 24 West Walton, Chicago, Illinois, 60610 U.S.A.

^aagvandarakis@cps.edu ^bkmstaral@cps.k12.il.us ^csjnoel@cps.edu

KEY WORDS: Manuscript, UNESCO World Heritage Sites, Elementary Education, WebQuests

ABSTRACT:

One of the monumental challenges that educators face on a day to day basis is engaging students in meaningful activities that require higher order thinking skills. Using the UNESCO World Heritage sites and their comprehensive webpage listings as vehicles for exploration, students in a middle school class work through an instructor-created WebQuest designed specifically to promote new technological skills and cultural exploration. This Quest itself is a multi-faceted teaching tool involving world wide web utilization, webpage creation and design, historical and cultural context analysis, digital geography and satellite map interpretation. The Quest project asks students to showcase cultural heritage/diversity and teaches the students aspects of an evaluation process that was necessary to identify current cultural World Heritage sites. The pinnacle of this evaluation was for the students to then recommend to their audience a potential World Heritage site. Nominations for new sites are based on cultural research and lived/virtual experience. It is then electronically exhibited through student created multimedia websites highlighting the recognized cultural World Heritage sites and ultimately offering a grounded proposal for the new location's acceptance. It seems important to note that students completed the first trial run with outstanding results. Clearly the most advanced thinking arose out of the relationship between lived experience and virtual exposure via electronic sources. A further bridge, not yet crossed, will entail expanded communication between cultures through video conferencing, visual blog communication and at its zenith, actual travel.

1. MANUSCRIPT

1.1 Introduction

In an already changing and diverse Chicago urban environment where buildings are torn down and built taller and larger sits a public elementary school. In the midst of this constantly changing landscape students at the William B. Ogden School are confronted with these rapidly evolving events. Homes and sometime entire neighborhoods have been and are continuing to be displaced. The Ogden student is losing the kind of cultural diversity, without necessarily knowing it, that defined not only Chicago, but this particular neighborhood of the Gold Coast. Set against this backdrop of gentrification, the motivation behind this project was to open our students' eyes to cultural preservation and local heritage as a springboard to world cultural preservation. Expanding on this tenet, we chose to introduce to our students the myriad locations that UNESCO and the World Heritage Centre has identified as World Heritage Sites. It's our opinion that teaching technology has to have a vehicle, a conduit that personal meaning and information passes through. This project marries the two entities of cultural heritage and technology.

The focus group of students that participated in this project was a 6th grade class of International Baccalaureate Preparatory candidates. Our twenty-five pupils, thirteen girls and twelve boys, are for the most part accelerated learners. Here in this class lies a microcosm of the school's diverse cultural makeup, as there are children of African, Asian, European, and Latin American decent.

class lies a microcosm of the school's diverse cultural makeup, as there are children of African, Asian, European, and Latin American decent.

2. OUR POPULATION

2.1 Ogden School students

Ogden School is one of 613 Chicago public schools. It is comprised of a wide panoply of students from many corners of our world. Over twenty-five languages are spoken within the halls of our building. As diverse as Ogden is, the cultural impact is lessened if existent, because of the nature of mobility and the transient tendencies of the families of our students. It is these students that we are to teach. It is our desire as educators to avail these children of preservation, whether or not it is an architectural landmark, a prairie, or an ethnic neighborhood. Without the means to travel nationally and internationally, technology becomes the obvious if not the only choice to explore and research this paradigm.

3. UTILIZING TECHNOLOGY

3.1 The WebQuest

A WebQuest is an inquiry-oriented student activity in which most or all of the information used by learners is gleaned from the Web. At the middle school level where students are somewhat technologically savvy, instructors create a guideline for research, analysis, synthesis and evaluation. A problem is posed to the learners and WebQuests are designed to maximize the learners' time in understanding and processing the problem. In order to focus on using information rather than looking for it, the instructor previews and decides on rich and appropriate websites that channels the learners' direction in navigating the web. The model was developed in early 1995 at San Diego State University by Bernie Dodge (Dodge, 2007).

The model was designed to illicit the higher order thinking skills (HOTS) that take students beyond recall and moves them toward drawing connections, formulating opinions, making evaluations and most importantly taking ownership of the information while applying it to their lives and to the world as they see it. The challenge here is that this is being done with students at a very early age. The model in its inception was designed for college students and here we are modifying it to engage a group of twelve-year olds.

3.2 Technology Skills

Coming into this project students had a set of technological skills that they could draw from. The incorporation of computer technology and its applications in several arenas of the curriculum had already been established. Students were proficient in web browsing, intermediate computer skills and rudimentary webpage designing.

3.3 Interdisciplinary Skills

Evidence in past classes of text and image analysis showed that the students were capable in these areas. Image analysis is particularly important here for several reasons. In our own collective backyard, we can go to ethnic neighborhoods or we can visit landmark architectural sites. However, the impetus here is to stretch our students' lens. We can't physically travel to most of the World Heritage Site locations. For comparison, as well as preservation purposes, the students needed access to the globe. Access requires the technological skills to navigate through the Internet and explore 360 degree panograph tours. They needed to present it to their classmates and the visuals are striking and engaging digital mapping skills and satellite imagery interpretation. Additionally the students needed background knowledge of historical and cultural context. Ultimately interdisciplinary skills catapult the learning process into HOTS.

4. IN THE CLASSROOM

4.1 The Project

The WebQuest project asked students to recommend a potential World Heritage Site. With this said, it became quickly evident to the students that they needed to come up to speed on what World Heritage Sites are. Why were those sites recommended? How could they themselves make a tenable offering of a location that would fit into the criteria of established sites? Based on cultural heritage and diversity, we facilitated the students *e-evaluation* process that is necessary to identify and classify current cultural World Heritage sites. Nominations for new sites are based on cultural research and lived/virtual experiences. Nominations were then electronically exhibited through student created multimedia websites. Students were divided into groups of three. Each group was then responsible for nominating one possible location for hypothetical consideration. The real work involved cultural and historical research which demanded students to look at existing sites in other countries focusing on similarities and making connections between them. Using the UNESCO World Heritage Sites website, Google Earth, digital maps and imagery, student groups designed a visual collage presented to their peers using student created websites as the mode of communicating their research and their candidate location. In making a recommendation to the class, students gravitated to locations

that had some personal significance in their lived experience. They then defended their proposed location incorporating their newly acquired *e-evaluative* skill set.

4.2 The Project's Challenges

The primary challenge of the project was in its intrinsic technological nature. As much as the students had been exposed to computers and their peripherals, groups faced a wide range of needed technological literacy. Some clearly moved faster than others. A secondary challenge was recognizing the fantastic imbalance of students' lived experiences. We have students in the class that have traveled on most of the continents, have seen monasteries in Tibet, have traveled the Great Plains of Africa, and have haunted the museums of Europe. Their ability to comprehend and digest web information was far superior to those students who have never left Chicago. In our challenges lies the work of teaching. We teach to transgress.

4.3 The Project's Success

Success is difficult to quantify, but, what was obvious to us in the project timeline was first the students' enthusiasm to work, to research, to share, to debate, and defend their thinking. The second pearl on the strand demonstrated peer-to-peer scaffolding on an intense level which motivated and propelled each group member to contribute their strongest skill. For example, in one group there was clearly the technological leader managing and explaining those tech tasks. In the same group was the traveler who gave his/her insight, experiences and shared those readily with others. The third member was the writer who lent their quill to paper in crafting the narrative which dovetailed into the imagery. Making a long list short, our final success was the outcome as a class. Each of the groups presented an accomplished website, including historical context, cultural importance, and relevant connections between locations, effective writing and solid proposal with a clear defense.

5. THE NEXT STEPS

5.1 The Future of the WebQuest

The next step that we see in evolving our WebQuest and subsequent research would be the incorporation of supplemental communication between our students and external sources utilizing video conferencing, webcams, web log communications, professional lectures and local field experiences that highlight community and cultural preservation. These augmentations will allow for greater breadth and depth in students' information gathering and processing, ultimately we hope, leading to the awareness and preservation of cultural heritage not only abroad, but here in Chicago.

5.2 International Partnership Extensions

For the past five years, Ogden School has committed tremendous resources in creating a robust, multi-layered international curricula. *Children's Horizons Opening In Chicago Education* (CHOICE) stretches our students' lens to see beyond a local portrait. There is a professional development component to CHOICE which avails our educators to stretch their lens and glean educational insight through dialogue and travel. To date, Ogden has formal international sister city partnerships with Mexico City, Mexico; Lyon, France;

Belgrade, Serbia; and grooming relationships with Vilnius, Lithuania; Prague, Czech Republic; and Beijing, China. International partnerships are a culminating and starting point all in one. Travel to these locations is exciting and a capstone on years of study. CHOICE offers four international field experiences each year in which students travel. In 2007, 35 students studied abroad. Yet, it is the virtual travel, communication, research and interpersonal connections that make this project part of daily teaching and learning. In using the WebQuest in conjunction with cultural heritage, we recognize the flexibility, daily contact, ease of use, and cost effectiveness of the virtual realms.

6. CONCLUSION

Teaching and learning is a double helix constantly building on itself; the two stay connected in perpetuity. It is our hope that through this WebQuest project and the additional layers of offered opportunities that we begin to see the strength and the power of virtual and physical connections. Using the evolution of technology, as it applies to cultural heritage preservation, we can share our learned experiences and ask for dialogues between us and that body of knowledge working collectively to promote global “*Digital Heritage: Our HI-tech-STORY for the Future.*”

7. REFERENCES

Dodge, B., 2007 “WebQuest.Org”, San Diego, CA.
<http://webquest.org/index.php> (accessed 3 June, 2008)

8. ACKNOWLEDGEMENTS

This work is supported by our partnerships with :
L’Institution des Chartreux, Lyon, France
Le Secundaria Anexia a la Normal Superior; México City, México.

THE USE OF 3D-SCANNING FOR THE STRUCTURAL ANALYSIS OF MASONRY VAULTS – A CASE STUDY ON THE SAINT-JAMES CHURCH

B. Van Genechten^{ab}, M. Santana Quintero^{ab}, L. Schueremans^c

^aUniversity of Applied Sciences St-Lieven, Gebroeders De Smetsstraat 1, B9000 Gent, Belgium

^bR. Lemaire International Centre for Conservation, KULeuven, Kasteelpark Arenberg 1, B3001 Heverlee, Belgium

^cDept. Of Civil Engineering, KULeuven, Kasteelpark Arenberg 40, B3001 Heverlee, Belgium
(Bjorn.vangenechten, Mario.santana)[@]asro.kuleuven.be - Luc.Schueremans[@]bwk.kuleuven.be

KEY WORDS: Laser scanning, Heritage, Structural Analysis, Restoration, Vaults.

ABSTRACT:

Three-dimensional laser scanning offers advantages for the recording and mapping of our built environment without entering in contact with the fabric and surfaces of objects. This is in particular interesting to fields where capturing the three-dimensional shape is of paramount importance, such as the industry, heritage and environment prediction. This paper presents one of three case studies carried out in the '3DRISK MAPPING' ("3DRISK MAPPING," 2008) framework, explaining the use of 3D laser scanning for structural assessments in restoration projects. It gives a critical appraisal of the process used in the preliminary research phase: gathering the point-clouds, 3D-modelling, structural analysis calculating thrust lines and the consolidation requirements that are obtained. The focus is on the added value of the methodology, its applicability, cost-effectiveness, overall advantages and drawbacks.

1. INTRODUCTION



Figure 1: Scanning of the masonry vaults, St.James Church (Leuven, Belgium), author.

The St. James Church situated in Leuven, Belgium, dates back to the year 1220 when the construction of the western tower

began. During several subsequent building phases, the Romanesque Church was replaced and extended by a Church in early Gothic style. The wooden roofs in the central and side naves were replaced with masonry vaults, and flying buttresses were added. The Church is approximately 62 meters long, 38 meters wide and 28 meters high from the ground up to the rooftop, not including the Church tower.

The church was built a former swamp indicating that the load-bearing capacity of the subsoil was limited. When time went by, this caused large differential settlements. In the past, restoration works took place at various times. However, due to the excessive cracks observed, it was decided in 1963 to close the Church to services, in fear of its structural collapse. During subsequent years structural supporting shoring was put in place to stop the Church from degrading. In 1995 the city of Leuven decided to restore the Church into its original state and to valorise it as a multi-cultural space. The focus of this paper is on the structural behaviour of the masonry vaults of the main nave.

In this type of masonry structures, vertical forces are transmitted by means of vaults towards the walls and foundation system. Since masonry mainly behaves as a non-tension material, lines of thrust have to be found in equilibrium with the actual loading, lying within the cross-section of the vaults. Therefore, the safety is directly related to the geometry itself and the analysis results strongly depend on the accuracy in which this geometry can be measured in practice.

Based on an accurate geometric survey, the overall geometry is determined. From the overall geometry, the geometrical safety factor is calculated by means of a limit analysis. As a result, a geometrical safety factor and the horizontal reaction forces at the abutments are obtained. The first is needed to judge the overall structural safety, the latter helps to determine optimal location for the strengthening using additional tie-rods. Therefore, this information is crucial for future consolidation measures, respecting the authenticity of the building and preserving it for the future.

2. LASER SCANNING FUNDAMENTALS

Different recording techniques exist to acquire an accurate geometric description of a building. Traditionally, total stations are used to record single points by measuring the time for a laser pulse to travel the distance to the object and back. These instruments are useful to record the most prominent features of the building like edges or single points of interest, but they lack the possibility to easily acquire complex surface structures. Other state-of-the-art techniques as close-range stereo photogrammetry and laser scanning have recently shown promising results in recording civil structures (Bonora et al., 2005; Guarnieri et al., 2006; Sternberg, 2006). However, each technique has its advantages and disadvantages.

Photogrammetric recordings are made by reconstructing three dimensional information from multiple photographs. Using a pre-calibrated camera, the position from where the images were taken can be computed by taking a number of control point measurements. Once the images are oriented, three dimensional information can be reconstructed by matching corresponding points in the images. In the early stages of photogrammetry this was done manually. Nowadays, thanks to the computer power, highly complex matching algorithms automatically detect matches and create a three dimensional model of the building. The problem with this technique is that it requires good lighting and sufficient texture. If these requirements are not fulfilled, the automatic matching algorithms fail to compute proper corresponding points. Therefore this technique is not useful when working in an interior with low light conditions.

Recently laser scanning is getting great interest for its relevant simplicity and speed. Laser scanning analyzes a real-world or object environment by measuring thousands of points with high accuracy in a relatively short period of time. Some scanners even have a built-in camera to acquire colour information that can be superimposed onto the geometric data. After an extensive processing phase, the collected data can be used to construct digital, two-dimensional drawings or three-dimensional models useful for a wide variety of applications. Laser scanning is like taking a photograph with depth information. Like cameras, they are line-of-sight instruments, so to ensure complete coverage of a structure, multiple scan positions are required. Different laser scanner principles exist, i.e. triangulation based, time-of-flight based and phase-difference based.

Triangulation scanners (Fig. 2) are devices that project a laser line or pattern onto an object and measure the deformation of that pattern using a visible sensor to determine the objects' geometry. The sensor, the pattern projector and the object being measured are configured in a triangle, hence the name triangulation scanner. Since the length of the baseline between the sensor and the projection device is limited by the field-of-view of the sensor, this type of scanners can only be used to measure objects up to a range of maximum 5 meters.

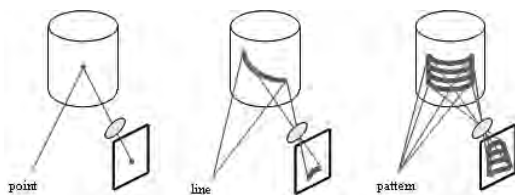

Figure 2: Triangulation scanner principle

Time-of-flight scanners compute distances by measuring the timeframe between sending a short laser pulse and receiving its reflection from an object. Since the laser pulse travels with a constant speed, the speed of light, the distance between the scanner and the object can be determined. These types of scanners are relatively slow (10.000 pts/sec), but can measure points up to 1 kilometer from the scanner without loss of accuracy. Phase based scanners use a modulated continuous laser wave in stead of laser pulses allowing for faster measuring (500.000 pts/sec). Because of the laser power required to modulate the beam to certain frequencies, the range of these scanners is limited to approximately 40-60 meters.

3. ACCURATE GEOMETRIC SURVEY

The choice of using laser scanning to record the masonry vaults was based on the required deliverables (3D surface model), the available time frame and the complexity and scale of the building. For this case study two scanners were used: the high precision Leica HDS 3000 to scan the exterior and the Leica HDS 4500 (53m model) to scan the interior, both owned by Plowman Craven a surveying company in the UK. The range and accuracy properties of both scanners are summarized in Table 1.

	HDS 3000	HDS 4500
Metrology method	Time-of-flight	Phase-shift
Range	300 m @ 90% albedo 134 m @ 18% albedo	53.5 m (default output power model)
Scan rate	Up to 4000 pts/sec.	Up to 500000 pts/sec
	Average: dependent on specific scan density and field-of-view	Average: dependent on specific scan density and field-of-view
Scan resolution		
Spot size	4 mm @ 0-50m	5 mm @ 10m 8.5 mm @ 25m
	6 mm (Gaussian - based)	
Field of view		
Horizontal	360°	360°
Vertical	270°	310°
Single point accur.		
Position	6 mm	7.5 mm @ 10m 15 mm @ 25m
Distance	4 mm	5 mm
Angle	60 micro-radians	350 micro-radians
Modelled surface precision	2 mm, one sigma	1.3 mm @ 10m 4 mm @ 25m
Laser		
Type	Pulsed	Continuous
Colour	Green	Red
Class	3R (IEC 60825-1)	3R (IEC EN60825-1)

Table 1: Technical specifications of laser scanners used in analysis

Scans made at different locations, especially the interior and exterior scans, are consolidated based on a closed reference network of control targets surveyed using a total station. During the scan acquisition phase, the targets are fine scanned to determine their exact position in the scan. Using the software provided by the laser scanner company, all scans, including the total station data, are registered using an iterative least squares adjustment algorithm. However due to human errors or software miss-interpretation errors, the data contains errors which make the registration more difficult (Fig. 4). It is therefore important not to rely on automatic procedures alone, but to always check the results of each automated step in the process.



Figure 4: A miss-positioned target vertex causing problems in the registration phase

The processing of point cloud data has already come a long way. Especially in the fields of piping and automotive industry, software exists to (semi-)automatically extract useful information from the point clouds. However, in heritage recording shapes are very irregular and organic, and more complex processing algorithms have to be used (Van Genechten et al., 2005). Even today with high-end computer technology, one of the biggest problems still remains working with very large datasets (up to 300 million points for the interior of the church). A number of different software packages for processing point clouds (i.e. Inus Rapidform XOR2, Raindrop Geomagic Studio v10 and Technodigit 3DReshaper) were tested using an Intel Core 2 @2.40GHz with 4GB of RAM on a 32-bit platform. Both 3DReshaper and Geomagic could handle the amount of data and provided meshed models with an appropriate level of detail, while Rapidform crashed on loading the dataset. While 3DReshaper was able to handle the data, it was a lot less user friendly in setting up parameters. Finally hole filling was applied to the models. The hole filling algorithms of 3DReshaper were quite limited and were difficult to use, while Geomagic proved very well and very efficient. Results of the meshed models using Geomagic Studio 10 are shown in Fig. 5.



Figure 5: Meshed models of the vaults of the St. James church

4. SAFETY OF MASONRY ARCHES

Based on this geometrical input, a stability analysis of the masonry vaults of the main nave was carried out. For the overall structural behavior, it is assumed that the main structural elements of the vaults are the cross-ribs where the shells transfer their loads to these ribs. To estimate this load transfer, the shells are split up in small sections. Each section is assumed to work as an arch. For each arch the thrust line method is used (Heyman, 1966). This is a Limit Analysis method using the equations of equilibrium and the resistance characteristics of the materials. It is supposed that the masonry blocks are infinitely resistant and the joints resist infinitely to compression and

shear, but do not resist to traction. Although these hypotheses are restrictive, it was shown in (Heyman, 1980) that under normal circumstances they are reasonable.

The safe theorem for an arch then reads (Heyman, 1966; Kooherian., 1952): *“If a thrust line can be found which is in equilibrium with the external loads and which lies wholly within the masonry, then the structure is safe”*. This theorem already suggests that more than one solution can be found. Indeed, any thrust line that satisfies the safe theorem requirements, is sufficient to ensure stability. It even does not have to be the actual line of thrust.

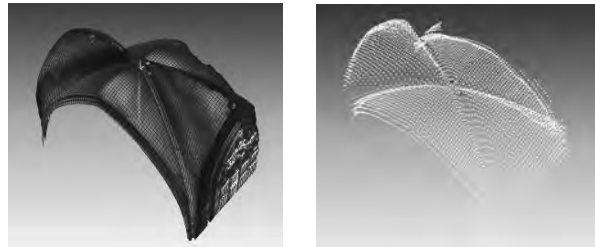

Figure 6: Grid projection onto the meshed model (reduced grid density for better visualization)

The manual calculation providing insight in the structural behaviour was extended using a limit analysis software tool developed in the framework of the Master and Ph. D. thesis of Pierre Smars, called Calipous (Smars, 2000). The Calipous software was devised to analyse the stability of masonry arches of complex geometry, possibly subjected to external loads and/or movements of abutments.

The input for the Calipous software consists of a series of text files, each representing the x,y,z coordinates of the points on an arch. Therefore a grid was projected onto the meshed model providing a dense gridded point cloud (Fig. 6). These points were then exported slice by slice and saved to a text file.

The overall results for the main nave of the St.-James church are outlined in Table 2, representing the vertical and horizontal reaction forces for the cross-ribs as well as the geometrical factors of safety. The minimum and maximum thrust lines for one section are shown in figure 7.

From this analysis it is clear that the overall geometrical factor of safety, which is larger than unity, demonstrates that the structure is in a safe situation. Because of the symmetry of both cross-ribs, which was also visible from their geometrical layout, the geometrical factors of safety are also comparable. In addition, the horizontal reaction forces are obtained. These reaction forces are used to design appropriate tie-rods, to replace the temporarily tie-rods that were placed when the original flying buttresses were removed in 2006 (Schueremans et al., 2007; Smars et al., 2006). The latter were removed since they became unstable due to the large differential vertical settlements in between the main nave and side nave.

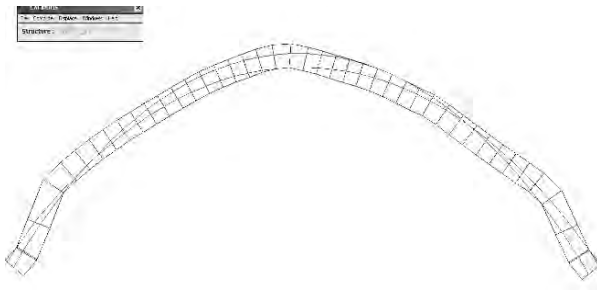

Figure 7: Minimum and maximum thrust for the example vertical section 1_11

	Vertical reaction forces V [kN]	Horizontal reaction forces		Geometrical factor of safety α_g
		Minimum thrust H_{min} [kN]	Maximum thrust H_{max} [kN]	
Diagonal AB				
Load case 1	97.	28.9	32.9	1.52
Load case 2		28.6	32.4	1.38
Diagonal CD				
Load case 1	103	26.9	29.3	1.28
Load case 2		26.6	28.9	1.65

Legend: Load case 1 and 2 represent the loading obtained from the minimum and maximum thrust from the shell sections that transfer their loading towards the ribs

Table 2: Horizontal and vertical reaction forces of the cross-ribs at the abutments and geometrical factor of safety.

5. CLOSING REMARKS

In this paper, high precision terrestrial laser scanning was used to provide a full geometrical description of one of the masonry vaults of the St.James church in Belgium for the use in structural analysis. After filtering and converting the raw point cloud data into a three dimensional model, a strategy was set up to convert this model into useable information for the structural calculation phase.

Although laser scanning is an evolving technology, it has already proven its usability in many cases (Alba et al., 2006; Guarnieri et al., 2005; Tsakiri et al., 2006). Since the complex question formulations for its particular uses are solved only by specific software programs, the use of third party software is vital.

The use of the geometrical data for structural analysis objectives of course is only one of the possible applications in case of the preservation of historical buildings. Future research subjects will focus on linking uncertainties related to loading, resistance and geometry to objective safety levels (Schueremans, 2001). The geometrical safety factor obtained from such an analysis is a safety ratio. In that, uncertainty in the analysis related to geometry, material resistance, loading or the calculation model used is not accounted for. Accounting for these uncertainties by means of probability density functions, would allow for an objective treatment of the uncertainties and the calculation of an objective failure probability.

6. REFERENCES

References from Journals:

Schueremans, L., Van Balen, K., Brosens, K., D., V. G., & Smars, P. (2007). Church of Saint-James at Leuven (B) – structural assessment and consolidation measures. . *Journal for Architectural Heritage*, 1, 83-108.

References from Books:

Heyman, J. (1966). *The Stone Skeleton: Structural Engineering of Masonry Architecture*: Cambridge University Press (May 26, 1995).

Kooharian., A. (1952). Limit analysis of voussoir (segmental) and concrete arches. . *American Concrete Institute*, 49(12), 317-328.

References from Other Literature:

Alba, M., Fregonese, L., Prandi, F., Scaioni, M., & Valgoi, P., (2006). *Structural monitoring of a large dam by terrestrial laser scanning*. Paper presented at the ISPRS Image Engineering and Vision Metrology.

Bonora, V., Colombob, L., & Maranab, B. (2005). *Laser technology for cross-section survey in ancient buildings: A study for S. M. Maggiore in Bergamo*. Paper presented at the CIPA2005 XX International Symposium, Torino, Italy.

Guarnieri, A., Pirotti, F., Pontin, M., & Vettore, A. (2005). *Combined 3D surveying techniques for structural analysis applications*. Paper presented at the ISPRS Working Group V/4 Workshop 3D-ARCH 2005: "Virtual Reconstruction and Visualization of Complex Architectures", Mestre-Venice, Italy.

Guarnieri, A., Pirotti, F., Pontin, M., & Vettore, A. (2006). *3D Surveying for Structural Analysis Applications*. Paper presented at the 12th FIG symposium on Deformation Measurements, Baden, Austria.

Heyman, J. (1980). *The Estimation of the Strengh of Masonry Arches*. Paper presented at the 69 Proc. INSTN Civil Engineering United Kingdom. .

Schueremans, L. (2001). *Probabilistic evaluation of structural unreinforced masonry structures* (Ph. D.): KULeuven.

Smars, P. (2000). *Etudes sur la stabilité des arcs et voûtes* (Ph. D.): KULeuven.

Smars, P., Schueremans, L., & Van Balen, K. (2006). *Monitoring the Dismantlement of Four flying Buttresses*. Paper presented at the SAHC 2006.

Sternberg, H. (2006). *Deformation Measurements at historical buildings with terrestrial laserscanners*. Paper presented at the ISPRS Commission V Symposium on Image Engineering and Vision Metrology, Dresden, Germany.

Tsakiri, M., Lichti, D., & Pfeifer, N. (2006). *Terrestrial laser scanning for deformation monitoring*. Paper presented at the 3rd IAG Symposium, Baden.

Van Genechten, B., & Neuckermans, H. (2005). *Fusing laser scanning and photogrammetry creating close range architectural orthoimages*. Paper presented at the 10th EuroPIA international Conference on Augmented Heritage, Damascus, Syria.

References from websites:

3DRISKMAPPING. (2008). Retrieved 25/08/2008, from <http://www.3driskmapping.org/site/>

7. ACKNOWLEDGEMENTS

The authors wish to acknowledge and thank the support of EU Leonardo programme and the Flemish Leonardo Agency for the financial support of the “3DRISKMAPPING” project.

In addition, we would like to thank the support of Simon Barnes (Plowman Craven Associates) to make the scanning and support possible of the St James Church. Special thanks to Huseyin Caner, Tim McDonald and Duncan Lees also from Plowman Craven Associates .

Documenting and Preserving Cultural Heritage for the Web

THE MATERIAL DESCRIPTION AND CLASSIFICATION IN NEPHELE SYSTEM FOR ARTWORK RESTORATION

M. Beneš^{a,*}, B. Zitová^b, J. Hradilová^c, D. Hradil^d

^a Dept. of Software Engineering, Faculty of Mathematics and Physics, Charles University, Malostranské nám. 25,
Prague, Czech Republic - benem9am@utia.cas.cz

^b Institute of Information Theory and Automation, ASCR, Pod Vodárenskou věží 4,
Prague, Czech Republic - zitova@utia.cas.cz

^c Academic Laboratory of Materials Research of Paintings, Academy of Fine Arts, U Akademie 4,
Prague, Czech Republic - janka@avu.cz

^d Institute of Inorganic Chemistry of the ASCR, Husinec-Řež 1001, Řež, Czech Republic - hradil@iic.cas.cz

KEY WORDS: Cultural heritage, Art restoration, Material analysis, Image segmentation, Image registration, Image retrieval

ABSTRACT:

We present a comprehensive information system for processing and archiving material analyses data produced during art restoration process - Nephelē. The Nephelē is a database system extended with image analyzing modules - image registration, segmentation, and object description and classification - designed for archiving and working with material analyses reports. The aim of the material analyses of paintings is to identify inorganic and organic compounds using microanalytical methods, and to describe painting layers and their morphology. Archiving all these data, Nephelē can act as a knowledge base and an expert system for future advanced analyses. Image-type data of the archived reports are pre-processed, analyzed, and described for further evaluation. Moreover, next to the classical text-query database search Nephelē supports report retrieval based on the similarity of the sample image to the archived image data, which can notably facilitate selection of relevant records to the current restoration case. In the near future, the Nephelē system will be extended by the module for automatic painting material classification based on neural network architecture and newly designed material taxonomy using object descriptors, capturing the layers morphology, their homogeneity or heterogeneity, and their color properties.

1. INTRODUCTION

Nowadays art conservators make use of new sensors and modern techniques to study, conserve, and restore old and often damaged artworks. Then, they are able to obtain more precise results by combining various data sources (Pelagotti, 2008). However the key issue of the art restoration stays still the same - an identification of the used materials. This is the subject of the material analyses research. Its aim is the location and the classification of inorganic and organic compounds using microanalytical methods, and description of painting layers and their morphology, where the layer is defined as consistent and distinguishable part of the painting profile. All this helps to determine the age of the used materials and their possible places of origin (Hradilova, 2003). Stratigraphy (learning about layers) is usually studied using visible spectrum images (VIS) - see Fig.1(left), ultraviolet spectrum images (UV) - see Figure1(right), and images from electron microscope (SEM).

As it is apparent from the previous, next to the new data acquisition sensors, methods capable of image analysis can be beneficial for restorers, too. Recently, there have been many papers on the exploitation of digital image processing methods for the art conservation and cultural heritage preservation in general, for example (Kammerer, 2003; Cappellini, 2003). Considering the stratigraphy and processing the multimodal images (VIS, UV, and SEM), there are several possibilities how image processing can be exploited.

We focused our research on the automation of the layer detection and description and on more efficient work with archived material analyses. In the past, all the image analysis work was done manually by experienced professionals. An automatic preprocessing of the input data can align images taken in different modalities by means of the image registration techniques, it can segment the individual painting layers and material grains, and, finally, it can help to represent detected layers and grains by means of the object descriptors, capturing the layer morphology, its homogeneity or heterogeneity, and its color properties. Such layer representation can be further used for material classification.

All proposed image processing modules were incorporated into the database system, handling results of material analyses in the form of reports. Material analyses report fully records the research of used painting materials, which contains general information about the artwork and the description and the results of analyzes which were held. Archive of such reports could serve as a knowledge base for future restoration cases. Having the image processing tools included into the database, the possibility of content based image retrieval facility has shown up. This feature enables, unlike the usual text querying approach, the retrieval of reports based on similarity of the sample image to the archived image data. The look-up using image similarities can notably facilitate selection of relevant records to the current restoration case.

* Corresponding author.

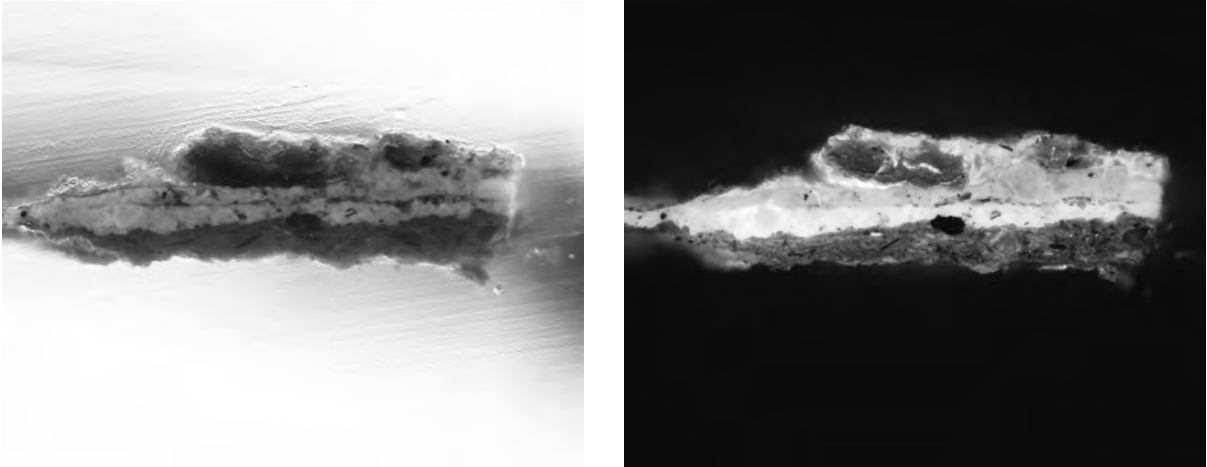

Figure 1: The images of the artwork cross-section: in the visible (VIS) – left – and in the ultraviolet (UV) – right – spectra.

2. SYSTEM NEPHELE

The Nephel system was designed for archiving and work with painting material research reports. The content of this extended database system reflects the structure of the report, which describes the process of material research of given artwork. It contains all acquired information about the object: general information about the artwork itself and its author, information about samples taken off of the artwork at several places, scanned parts, and results of chemical analyses. Such database with broad spectrum of reports can serve as the knowledge base for future restoration cases. Possibly the most important functionality of the system is the search function, which selects required reports. The user has two options: to use textual information for looking up the report, or content-based image retrieval, which compares archived image data with the query image sample. The latter is enabled due to the included image processing modules, which go beyond the ordinary database functionality and are intensively used in the very process of artwork analysis and report creation.

The illustrative example of user interface can be seen in Figure 2. The restored artwork is shown, with VIS, UV and SEM images of one microscopic cross-section. The software was implemented in C++ programming language with .NET framework support on client side. The database is based on relational model with SQL querying language.

3. IMAGE ANALYZING MODULES

Several image analyzing modules are incorporated in the Nephel system. They were designed for processing input image data acquired during the material research: microscopic images of minute surface samples (0.3mm in diameter). They are taken off of the selected areas, embedded in a polyester resin, and grounded at a right angle to the surface plane to expose the painting layers of the artwork. The microscopic images are taken in several modalities. Stratigraphy (learning about painting layers) is usually studied in VIS and UV images, where the UV analysis makes use of the luminescence. Different materials have different luminescence, which can help to distinguish materials not resolvable otherwise. Lately, the data set was extended by SEM images from electronic microscope.

The ultimate goal of the image preprocessing is the identification and description of the individual material layers. Before the layer localization can start, the multimodal input data have to be brought into geometric alignment, because the VIS and UV image pairs of the sample are often geometrically misaligned due to manipulation errors etc. They can be mutually shifted and rotated in the scanning plane. The proposed image registration module of the system solves the spatial alignment of the image pairs.

Now the color layers can be estimated. The segmentation module performs segmentation of the cross-section from the noisy background and also preliminary layer segmentation based on both VIS and UV images. The construction of the full and correct segmentation turns out to be a very complex task, because expert knowledge is often necessary (certain materials cannot be neighbours, others are always together, etc.).

After the layer segmentation, we have the set of base structures, which are homogenous and can be further described, analyzed and used for more sophisticated tasks such as image based retrieval or material classification.

3.1 Image registration

Image registration is the process of overlaying two or more images of the same object taken at different times, from different viewpoints, and/or by different sensors. The task of VS and UV registration belongs to the multimodal registration category, where images of the same scene are acquired by different sensors. The main complication of such task is that the intensity values do not correspond to each other and it is more complicated to find an appropriate similarity function or features, which are invariant to such changes. Mutual information (MI), originating in the information theory, is recognized solution for the multimodal registration problem. It is a measure of statistical dependency between two data sets and it is particularly suitable for registration of data from different modalities. MI was chosen because it does not impose strong limitations on used sensors. One of the first articles proposing this technique is (Viola and Wells, 1997).

In our approach, we use a speed up technique of the method, based on averaging pyramid together with discrete estimate of



Figure 2: Illustrative example of Nephele user interface.

histogram. The optimization of the maxima location is a modified version of the method published in (Penney, 1998). Moreover, we exploit one-channel data, either green channel of the RGB image representation or the first element of principal component transform (PCT), to reduce the dimensionality of the problem.

3.2 Image segmentation

Image segmentation is the process of separating the input image to multiple regions, which represent consistent and distinguishable parts of the painting profile. The image segmentation task consists here of two steps: first, the cross-section has to be isolated from the background, and second, the painting layers of the sample are distinguished.

3.2.1 Background segmentation: During the acquisition process, the cross-sections are photographed along with polyester resin, which forms the noisy background of the image

(see Figure.1). This should be removed before any other image processing technique can be applied. The proposed method is based on appropriate thresholding of pre-blurred image, which diminishes the hostile effect of the errors in the resin. The blur smooths the input image; therefore the cross-section can be clearly separated from the background.

3.3.2 Layers segmentation: Input information to the module for the layer detection consists of the set of three RGB channels of VS and three RGB channels of UV specimen images. Various segmentation methods were tested and compared to the ground truth provided by experts. We found out that expert knowledge is used widely during the segmentation process, such as an enabled and disabled adjacency of layers, obligatory sequences etc. Thus we restricted ourselves to producing preliminary estimates of the color layer segmentation as the first proposal for the operator. It is possible to include the expert knowledge for layer order using the feedback; this is one of our goals for the future. However, even this first sketch can

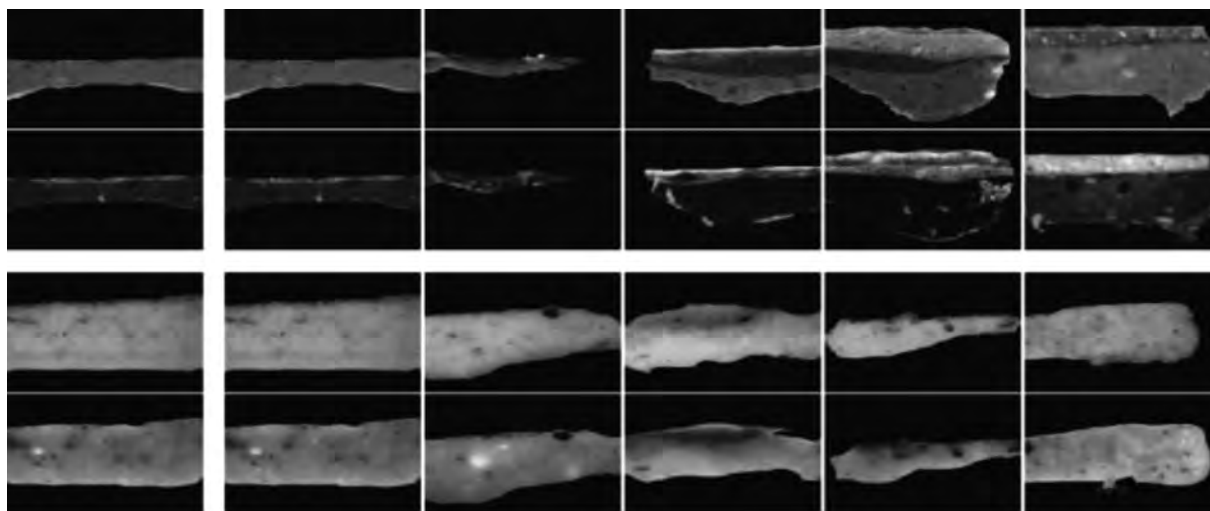

Figure 3: Results of the image retrieval. Left column contains query specimens; next columns in the corresponding rows are results of the retrieval in order of similarity

considerably facilitate the tedious manual work needed.

The proposed method is based on the cluster analysis using the VIS and UV six color channels plus spatial information (x and y coordinates are included as another two channels). It starts with iterative {k-means} clustering, where the number of classes is set a priori as a maximum expected number of layers by the user. The enhancement of the results was achieved after applying morphological operators on detected segmentation and performing minimum class check.

For better functionality of the Nephele database, effective tools are implemented to look-up relevant reports. One of them is content-based image retrieval (CBIR), which is recently very popular (Veltkamp and Tanase, 2000) and is used as a part of multimedia systems in art galleries (Addis, 2003; Goodall, 2004). The image retrieval exploits similarity of the query sample to the images contained in the archived reports. The visual similarity can point to the same author, used material, or technique. In our Nephele system, we applied two possible classes of used features: the energy descriptors (Smith and Chang, 1994) computed from the wavelet decomposition of the SEM images and the combination of texture features – the co-occurrence matrices and Haralick descriptors (Haralick, 1973) – and color features – the image average color and the spectral standard deviation, both applied on VIS and UV data. The weighted Euclidean metric was chosen and the R*-tree indexing structure (Beckmann, 1990) was implemented to speed-up the retrieval. Figure 3 shows the applicability of the second approach. Leftmost column represents query images. The most similar responses are in the respective rows in order of similarity from left to right.

4. THE MATERIAL DESCRIPTION AND CLASSIFICATION

As it was stated before, the classification of the used materials is a key issue in the restoration process and task of our near future work. Our preliminary idea is to exploit texture patterns of the material and describe it with a set of descriptors. Afterwards multilayer backpropagation neural network will be used for material classification and identification. Neural networks are often used as classifiers in pattern recognition (see (Bishop, 1996)). The layers segmentation can use this method as well in the future.

Other possibility is to exploit the morphology of the layers. One material is among others determined by its shape, size, and density of the grains. One of the first necessary steps forward is segmentation of the grains in the individual layers. Our algorithmic solution of grain segmentation is based on parametric snakes and works on the SEM data (Xu and Prince, 1998).

The proper design of the material descriptors is tightly tied down with the systematization of features important for the material classification. It is important to know which characteristic is able to distinguish among two used materials and thus what we should be focused on. We plan to create such taxonomy of material descriptors as a byproduct of the proposed research.

5. CONCLUSION

The proposed system Nephele can help art restorers and conservators in their work and offer them better access to the archived material reports they use. The image processing methods (image registration, segmentation, and object description) improve the outcome of the analyses and the database. The included image retrieval system is able to provide fetching of reports with visually similar cross-section data. This functionality eases the complicated task of the retrieval of relevant experience from previous restoration cases.

The future work is aimed to precise identification of the used materials in single layers. Presented examples of achieved results show the applicability of the system. All work was realized in close cooperation with the experts from Academic Materials Research Laboratory for Painted Artworks, joint site of the Academy of Fine Arts in Prague and Institute of Inorganic Chemistry AS ČR.

6. REFERENCES

- Addis, M., Boniface, M., Goodall, S., Grimwood, P., Kim, S., Lewis, P., Martinez, K., and Stevenson, A., 2003. Integrated image content and metadata search and retrieval across multiple databases. *LNCS*, 2728, pp. 91-100.
- Beckmann, N., Kriegel, H.-P., Schneider, R., and Seeger, B., 1990. The R*-tree: An efficient and robust access method for points and rectangles. In *1990 ACM SIGMOD International Conference on Management of Data*, 19, pp. 322-331.
- Bishop, C. M., 1996 *Neural networks for pattern recognition*. Oxford University Press, Oxford, UK.
- Cappellini, V., Barni, M., Corsini, M., Rosa, A. D., and Piva, A., 2003. Artshop: an art-oriented image-processing tool for cultural heritage applications. *Journal of Visualization and Computer Animation*, 14, pp. 149-158.
- Goodall, S., Lewis, P. H., Martinez, K., Sinclair, P., Giorgini, F., Addis, M., Boniface, M., Lahanier, C., and Stevenson, J., 2004. Sculpteur: Multimedia retrieval for museums. *LNCS*, 3115, pp. 638-646.
- Haralick, R. M., Shanmugam, K., and Dinstein, I., 1973. Textural features for image classification. *IEEE Transactions on Systems, Man and Cybernetics*, SMC-3(6), pp. 610-621.
- Hradilova, J., Hradil, D., and Bakardjieva, S., 2003. Microscopy in conservation. *Vesmír*, 12, pp. 676-681.
- Kammerer, P., Zolda, E., and Sablatnig, R., 2003. Computer aided analysis of underdrawings in infrared reflectograms. *Proc. of the fourth Int. Symp. on Virtual Reality, Archaeology and Intelligent Cultural Heritage*, VAST2003, Brighton, England, pp.19-27.
- Pelagotti, A., Mastio, A. D., Rosa, A. D., and Piva, A., 2008. Multispectral imaging of paintings. *IEEE Signal Processing Magazine*, 25, 27-36.
- Penney, G. P., Weese, J., Little, J. A., Desmedt, P., Hill, D. L. G., and Hawkes, D. J., 1998. A comparison of similarity measures for use in {2D--3D} medical image registration. *IEEE Trans. Medical Imaging*, 17, pp. 586-595.

Smith, J. R. and Chang, S. F., 1994. Transform features for texture classification and discrimination in large image databases. *Proc. IEEE Intl. Conf. on Image Processing (ICIP)*, pp. 407-411.

Veltkamp, R. C. and Tanase, M., 2000. Content-based image retrieval systems: A survey. *Technical Report*, UU-CS-2000-34.

Viola, P. and Wells, W. M., 1997. Alignment by maximization of mutual information. *International Journal of Computer Vision*, 24, pp. 137-154.

Xu, C. and Prince, J. L., 1998. Snakes, shapes, and gradient vector flow. *IEEE Trans. on Image Processing*, 7(3), pp. 359-369.

7. ACKNOWLEDGEMENTS

This work was partially supported by the Grant Agency of Charles University under the project No. 72507, partially by the Ministry of Education of the Czech Republic under the projects No. 1M0572 (research center) and No.MSM6046144603, and finally by the Grant Agency of the Czech Republic under the project No. 203/07/1324.

COMPARATIVE EXPERIMENTATION AND VERIFICATION EXPERIENCE-TYPE EDUCATIONAL MATERIALS AND DISPLAY-TYPE EDUCATIONAL MATERIALS

Hiroshi Suzuki^{a*}, Akira Ishida^b

^{a*}Kanagawa Institute of Technology, 1030,Shimoogino,Atgui,Kanagawa,Japan hsuzuki@ic.kanagawa-it.ac.jp

^bInstitute Advanced of Media Art and Sciences, 3-95,Ryokecho,Ogaki,Gifu,Japan ishida@iamas.ac.jp

KEY WORDS: Interactive education material, Museums attraction, Interface, RFID, Workshop

ABSTRACT:

Today's workspaces for computer-based interactive pieces are dramatically improving due to augmentation of various development tools. As a result, experiential media educational materials that respond to visitors' actions and behaviour are appearing at many museums. However, there have been few research examples showing the features and the effects of experience-type educational materials that stimulate the impulse to learn, and improve concentration and thinking power more than traditional desktop media educational materials. In this research, we developed both types of educational materials using the same learning methods and scenarios. The objective was to elucidate what kind of differences could be found between experiment- and desktop-type educational materials.

1. INTRODUCTION

1.1 Research Background

These days we see quite a few museums that shows computer-based interactive works. It is said that the multimedia attraction is increasing visitors interest(1). So, It is highly possible that experiential media educational materials will be actively introduced in the future. There types of educational materials were thought to require expert knowledge and skills, a high cost for development. However, lately various development tools are appearing such as "Gainer" (2,3)and "Arduino" which are i/o devices that can allow relatively easy sensor control easily, and "OpenCV" or "FericSDK" that can use image data processing and RFID systems easily. If these development tools are used, specialist skills in electronics and informatics are not necessarily required. Also the cost of production for experience-type educational materials will gradually decrease as these development tools spread and technology advances. So, in the future, experience-type educational materials will be appearing not only in the limited places such as museums but also sightseeing spots, event sites, showplaces, etc. which are educationally and culturally suitable for these materials.

1.2 Aim of Research

The Target of experience-type educational materials installed in museums is to make intended learners use their body to help them comprehend museums' collections or to invoke learners' interests to learning themes. As an ingenious way to make learners reach the material, the experience-type educational materials with the most advanced technologies are designed to entertain learners.

For instance, in "Arithmetik Garden"(4) developed by Sato and Kiriyaama with RFID technologies, visitors can enjoy learning abstract idea of calculation, by going several times through the gates that mean numbers and operators. However, I do not agree with the idea that these experience-type educational materials directly connected to learners' interest to learning theme.

After developing "Probe×Globe"(5) in 2006, The workshop where this educational teaching material was used has been executed many times up at event sites, amusement parks and elementary school.

As we conducted the workshop, we were able to show that those education materials provided for learner's enjoyable learning environments. However, it is not to say that attractive educational materials increase learners' interest to learning subject. Moreover, there have been few research examples showing the features and the effects of experience-type educational materials that stimulate the impulse to learn, and improve concentration and thinking power more than usual desktop-type media educational materials.



Figure 1: Figure of "Probe×Globe"

Revealing the characteristics of each media material provides an indicator that tells which educational materials are to effectively be used depending on the place and situation. And it is also possible to create a learning environment that is more attractive and effective for learners. Then in this research, we developed experience-type and desktop-type educational materials using the same learning methods and scenarios. The objective is to elucidate what kind of differences could be found between both educational materials.

In this paper, we report the learner's first impressions to both materials and their degree of usability, difficulty and enjoyment according to age group and interest to learning subject.

2. RESEARCH PLAN AND METHOD

2.1 About the "Probe×Globe"

In this research, in order to compare the experience-and desktop-type educational materials we used "Probe×Globe," an experience-type learning material employing RFID. Figures 1 and 2 show the "Probe×Globe" in use.

The developed "Probe×Globe" was constructed out of the following three items and a server.

1. **Knockdown Globe:** The knockdown globe is an icosahedron constructed from twenty map panels in the shape of 90cm equilateral triangles and a frame. RFID chips are affixed on the backside of the map panels so that 30 points on the globe can be identified. The RFID chips can be affixed anywhere on the panels, so it is possible to change the positions according to the contents. IDs are allocated to the RFID chips to be used to retrieve video or sound contents stored in a database.

2. **Contents Cards:** Contents cards hold information such as text and illustrations that are used in the contents. Like the panels, the cards are embedded with RFID chips. The number of cards used can be raised proportionally to the number of RFID chips used, but in this case we made 30 cards corresponding to the map panels.

3. **Contents Server:** The contents server processes the information received from the contents reader, and transmits videos, photographs, and other contents from the contents database to the contents reader.

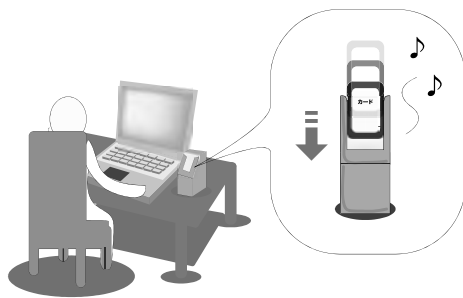

Figure 3: Image of using "Probe×Globe for Desk top"

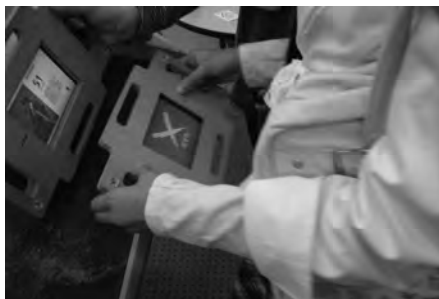

Figure 2: Figure of Contents reader

The scenarios of the learners of this leaning system who used this learning material comprise of the five following steps.

1. The learner sees a picture of the folk performing arts are from according to the costumes and appearances of the folk performance arts on the contents card and guesses.
2. The contents card is made to be read by the terminal of a portable RFID reader.
3. The learner searches the icosahedron globe for the region of the folk performing arts.
4. When the learner makes a guess at the location, it is held to the corresponding place.
5. If they are correct the contents reader will play a video of the relevant folk performance arts. And If they are incorrect, an image will display showing them their answer is incorrect.

The learners are able to learn world geography and understand different cultures by repeating trial and error across these five steps.

In this research, the desktop-type educational materials "Probe×Globe for Desktop" was newly developed based on the study scenario of this "Probe×Globe".

2.2 Outline of "Probe×Globe for Desk top"

"Probe×Globe for Desk top" is multimedia educational materials designed to experience Probe×Globe on a desktop computer.



Figure 4: User interface of "Probe×Globe for Desktop"

This education material features a GUI where users indicate a position on the earth using a computer mouse instead of the Knockdown Globe. A capture image of the developed educational materials is shown in use in figure 3, and the interface is shown in figure 4. Figure 5 is the configuration "PxG 4 desktop".The card reader used for reading RFID of the contents card was a special RFID reader able to connect to the desktop personal computer.

The RFID system determines if the position of the f p a recorded on the card matches with the region that the learner indicates on the map of the GUI. If the learner is correct the contents reader plays a video of the relevant folk performance arts on the desktop. If the learner is incorrect, an image will be displayed showing them their answer is incorrect."PxG 4 desktop" has the exactly same contents and study scenario as "PxG" has. The only difference between them is the interface parts.

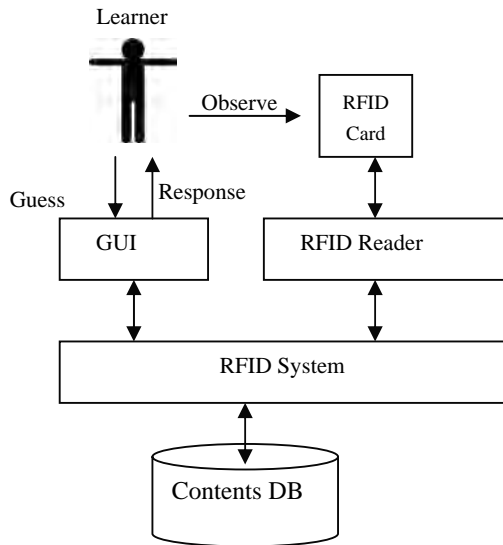

Figure 5: System configuration figure

3. COMPARATIVE EXPERIMENTATION

We exhibited both educational materials at the interactive lab public space in Ogaki, Gifu using both PC and multimedia educational materials, to conduct the comparative experiment. This education material learning theme is international culture understanding and geography. So that experimentation participates were 4th graders in elementary school to 2nd graders in junior high school. Because of they are begins to learn the geography at the school in Japan.

We chose at random from among children in the object that had come to the experiment site. The table1 shows participant's breakdown. The experiment participants numbered 28 in total from. First, instructions for use of both materials were explained to the children. Then the children chose their favourite folk performing arts card from the 30 available.

School year	Number
Elementary school 4th	11
Elementary school 5th	5
Elementary school 6th	2
Junior high school 1st	7
Junior high school 2nd	3
Total	28

Table 1: Participants' breakdown

Next, the children used both "P×G" and "P×G 4 desktop" for 30 minutes each. We don't indicate using order for both education materials to all children. Finally, we conducted a survey after they had tried both materials.

The content of document investigation is as follows.

1. "Do you like geography?"
2. "From your first impression, how much did you want to try the materials?"
3. "How enjoyable was the actual experience?"
4. "How easy was it to use?"
5. "How difficult did you feel it was?"

The five questions above were answered on a five point, evaluation based on the person's subjective experience.

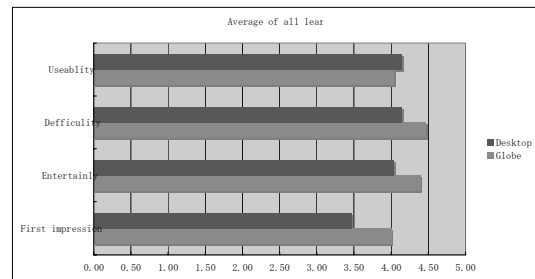

Figure 6: Average of all Learners

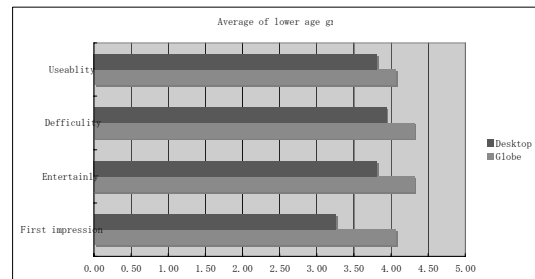

Figure 7: Average of lower age group

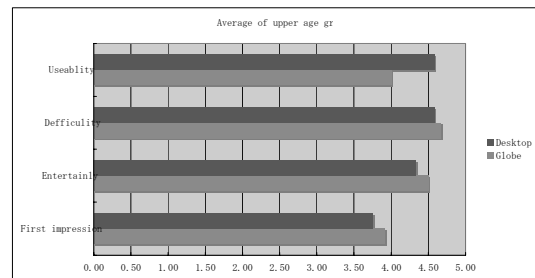

Figure 8: Average of upper age group

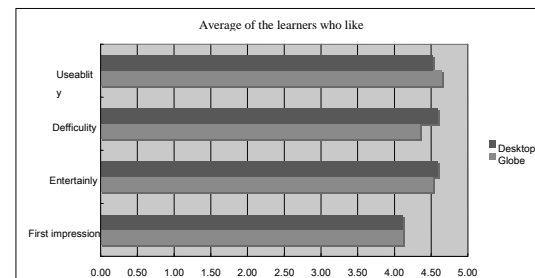

Figure 9: Average of the learners who like geography

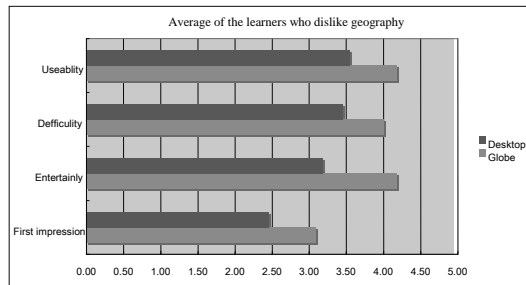

Figure 10: Average of the learners who dislike geography

4. RESULTS AND CONSIDERATIONS

The table shows the mean values of the answers to the questions. Tables 1, 2 and 3 represent the average values for all learners, the lower age group (elementary school 2 years -5 years, number 16), and the upper age group (elementary school 6 years - junior high school 2 years number 12) respectively.

When all learners' graphs are seen, it is understood there was a good first impression of the experience-type educational materials. Moreover, though only by a few points, the experience-type scored higher than the desktop-type in for enjoyment and usability.

Looking at the response of the lower age group, participants wanted to try the experience-type more than the desktop-type appeared. Similarly, the experience-type materials scored slightly higher than the desktop-type for enjoyment, usability and difficulty level.

In comparison, the experience-type materials scored slightly higher than the desktop-type materials in first impression, operability, and enjoyment in average of the upper-age group. But, in operability, the desktop-type materials outscored the experience-type materials, unlike the other three questions.

When analyzing the survey results revealing differences in interest of geography, there was little difference between the scores for learners who answered they enjoyed geography, whereas for learners who disliked geography, the globe outscored the PC version.

In light of these results, observations suggest that for learners, the experience-type materials are easier to grasp and make for smoother learning of the theme than the desktop-type. Further, the differences are remarkable when looking at each age group separately.

Learners in the lower age group were very interested in the experience-type educational materials, outscoring the desktop-type in enjoyment, difficulty level, and operability. However, the upper age group showed little difference in preference, with operability of the computer mouse in the desktop-type scoring higher than the portable terminal in the experience-type materials. The reason is thought to be that as learner age, they have more opportunities to use PCs, and have become used to computer mouse PC operations.

When analyzing the survey results revealing differences in interest of geography, learners who answered that they enjoyed geography scored high overall, suggesting that learners who

enjoy geography little preference between the experience-type and desktop-type materials.

In comparison, results from learners who answered that they disliked geography showed that experience-type materials score higher. This suggests that there is a high possibility that learners who are not interested in geography were able to draw more motivation for study and become interested in the learning theme from the experience-type materials over the desktop-type materials.

5. CONCLUSION AND FUTURE TASKS

The objective of this research was to examine the learning effect of experience-type educational materials. To this end, experience-type media educational materials and desktop-type media educational materials were developed with the same learning scenario but different interfaces. For this study, we compared the two materials in terms of learners' interest and ease of engagement.

The results made the following two points clear educational materials

1. According to the participants' subjective views, the experience-type educational materials had little effect on upper age groups, but attracted the interest of lower age groups.
2. Experience-type educational materials score high in terms of first impression and learning experience for learners who dislike the learning theme, suggesting that these materials may be effective in motivating these learners to learn.

Further work includes providing quantitative evaluation in the form of paper tests before and after the learning experience in addition to surveys.

Further, educational materials will be developed for touch panel portable terminals such as the "Nintendo DS" in addition to desktop-type materials to provide further comparisons in interfaces and examine the potential of experience-type media educational materials.

6. REFERENCES

- Lindgren-Streicher, A. and Reich, C., "Visitor Interactions with Digitized Artifacts", Museum and the Web2006, Archives & Museum Informatics, http://www.archimuse.com/mw2006/abstracts/prg_300000755.html (accessed 28 Jun. 2008)
- Endo Takanori, Kobayashi Shigeru, Akabane Kyo, 2008 Prototyping with Gainer, the 55th Annual CONFERENCE of JSD, Japanese Society for the Science of Design, June 18.
- Junichi Kanebako, James Gibson, 2007. Dr. Laurent Mignonneau. Mountain Guitar: A Musical Instrument for Everyone. In Proceedings of NIME'07, pp. 396–397.
- Masahiko Sato, Kiriya Takashi, 2007. Arithmetic Garden, ICC Kids program 2008. Transformyourself, <http://www.nticc.or.jp/Archive/2008/Kidsprogram2008/Work/work6.html> (accessed 28 Jun. 2008)

Hiroshi Suzuki, Tadahiko Sato, Akira Ishida, Koji Yamada, 2006. Developing and Analyzing Geographical Content Display System by Using RFID, 12th International Conference, Vsmm2006 Xi'an, China, October pp.338-348.

Koji Yatani, Masanori Sugimoto, Fusako Kusunoki, 2004. A System for Supporting Children's Collaborative Learning in a Museum with PDAs, 2nd IEEE International Workshop on Wireless and Mobile Technologies in Education (WMTE'04), pp. 109.

Lydia Plowman, Rosemary Lucjkin, Interactivity nterface and Smart Toys, 2004. <http://csdl.computer.org/comp/mags/co/2004/02/r2toc.htm>(accessed 28 Jun. 2008)

VIRTUAL REALITY WEB COLLABORATIVE ENVIRONMENTS IN ARCHAEOLOGY

Maurizio Forte^a, Eva Pietroni^b

^a University of California, Merced – mforte@ucmerced.edu

^b Institute of Technologies Applied to Cultural Heritage, CNR, Rome – eva.pietroni@itabc.cnr.it

KEY WORDS: virtual reality, multiuser domain, embodiment, archaeology, cyberspace, collaborative environments, web.

ABSTRACT:

This paper presents the outcome of the research project: “Integrated Technologies of robotics and virtual environments in archaeology” (Firb), financed by the Italian Ministry of the University and Scientific Research. The aim of the project is to experiment and realize a multi-user domain on the web aimed to a multidisciplinary scientific community: archaeologists, historians, experts in human and social sciences, communication experts. The capacity to load, share and interact with data in the same spatial virtual environment can increase the level of learning and scientific communication. The project is the result of the collaboration between CNR-ITABC of Rome, the Department of Archaeology of the University of Pisa and Scuola S. Anna of Pisa, focuses on three archaeological sites: *the Teban tomb 14 in the necropolis of Gurna-Luxor, Fayum Medinet Madi*, both in Egypt, and *Khor Rori*, in Oman. The collaborative environment is constructed through a virtual reality system. This allows to create a virtual space where it is possible to share 3D information on the project and to host additional behaviors of the scientific community. Each user can choose an avatar and enter in the web community: so he/she can visit, interact, dialog, open cultural contents, metadata and so on. In case of changes of scenarios, it is possible to download and modify the virtual environment in the scene editor. For example it is possible to transform the conceptual map of the information system, or to modify the cybermap creating new key concepts and new relations, moving objects and linking metadata. At the end the users can save the contents in text format, and upload the scene on server with additional metadata or contents. All the following versions elaborated by the users will be saved in a repository on the server and accessible by the web community through a special interface. The architecture of application is open: graphic tools and behaviours are implemented inside both the editor and the MuD as separate modules.

1. INTRODUCTION

1.1 Cybernetic approach and multiuser domain

The growing impact of the digital informational metabolism of Internet in the society has created unpredictable results in a very short time: millions of people inter-connected and able to share and construct cybernetic contents, but which contents (Jones, 2003)? This overload of information is really able to create new forms of learning and cultural transmission? What kind of information is transmitted to the future? Which expectations we can have from the new virtual ecosystems? What we know is that this digital eco-culture creates different relations and feedback; we are moving in the era of the 3D cyberspace where we assist to the embodiment of cross cultural and multidisciplinary communities. If in the past decade Internet was principally based on multimedia browsing and structured contents, the new generation of Web is self-organized and reticular, made by de-structured contents and by 3D self-made cyber-spaces. Can this continuously evolving universe of information really construct communication and knowledge? Every complex phenomenon needs time to be monitored and studies, so it is difficult to have an answer today. We like to define the multiuser environments of cyberspace “mirror communities”, because every user/avatar/models-maker makes his/her knowledge throughout the feedback of other users/avatars, so in some way his/her activity is reflected in/from other activities. Moreover the user can see him/herself from any spatial perspective, so he/she embodied in the system; this embodiment constitutes the new frontier of the informational and communicational process. Every information is surrounded from reticules of additional information, like a universe able to contain infinite sequences of other worlds. How can we define this embodiment? In the ecological thinking

the learning process depends on the capacity to produce difference between organisms and ecosystems (Bateson, 1979). Therefore is the embodiment able to produce difference? There is a fundamental difference between traditional virtual communities and embodied communities: the first ones use mainly 2D interfaces and chatting, the second ones use 3D dynamic behaviours and interactions. The embodied communities use a principle of enaction for perceiving and constructing the information (Mellet-d'Huart D., 2006). The term « enaction » was introduced firstly by Bruner (Bruner, 1968) for designing the knowledge is knowledge coming through action and constructed on motor skills. Then the concept was re-elaborated by Francisco Varela (Maturana H., Varela. F., 1980) which defined a new paradigm in cognitive science, “based not on the metaphor of the computer as in classical cognitivism, but instead on the metaphor of living organisms” (*Enaction and Cognitive Science*, <http://iris.cnr.fr/enaction/index-en.html>).

This neuro-phenomenologic approach is based on the assumption that the cognitive activity is “embodied”, or not separated from the body perception. In these terms it could be identified and communicated only within a specific context. It seems evident that embodiment depends on the level of the engagement inside the cyberspace: so, in theory, the embodied communities should learn and transmit more knowledge and in a shorter time than the traditional “chatting” communities. Unfortunately to transmit knowledge does not mean to transmit cultural information; we have a very limited understanding of how the virtual spaces created by different software and environments differ in the impact on user interactions and cultural learning. The need to create a new dictionary can be explained from the growth of the embodied communities

(Gerosa, 2006) and from the birth of distributed forms of digital and social popularization, the cyber games.

In this panorama (Jones, 2003) the cultural experiences of embodied virtual communities are still a few, in particular in archaeology. In short we can categorize these kinds of experiments in two classes: collaborative augmented environments (just for small communities of researchers) and virtual social communities, such as the case of Second Life. A good example of the first category is VERA, Virtual Research Environment for Archaeology, a system able to facilitate collaborations amongst the archaeological researchers, on-site teams and interested Internet community, providing them with the enhanced means of collaborating, collating, manipulating and managing data and information, as well as collective knowledge creation (Benko *et alii*, 2004, 2005).

An interesting example in Second Life is the case of the Okapi Island (Okapi 131.116.46 (PG)). Okapi Island allows one to virtuality explore and develop their own sense of place at the archaeological site of Çatalhöyük. This initiative comes from the University of Berkeley (Ruth Tringham and Noah Wittman) and it is aimed to introduce the site to students and visitors with webcasting and interactive activities.

This approach validates the principle that there is an enormous potential for archaeology, cyber, *enacted* and embodied in the future development of 3D Web communities. The embodied information and the creation of cyber spaces for the archaeological and cultural consumption and communication can represent a totally innovative gateway to the simulation and reconstruction of the past. Simulation, feedback and communication constitute the most important factors in the cyber archaeology, like the case studies here presented can show. In this scenario the correct approach is to increase the interactive space of “floating information”, validating the scientific interpretation in interactive ways.

The cyber space of the FIRB project is a sophisticated collaborative environment of simulation for academic studies. Action, behaviors, feedback and interaction constitute the content, the place where everything can happen, the real content. In the cyberspace the 3D modeling represents the background; the foreground is created by the relations between people/avatars, territories, artificial societies and digital information.

2. THE INTEGRATED TECHNOLOGIES OF ROBOTICS AND VIRTUAL ENVIRONMENT IN ARCHAEOLOGY PROJECT

2.1 Embodied virtual Communities: a new opportunity for the archaeological research.

Usually the scientific humanistic communities do not consider VR environment an operative tool for research. In particular on the web, there are a few examples of 3D e-learning and VR laboratories, virtual domains where researchers and humanists can share data, interpretations, hypotheses and data.

The key problem concerns the creation and dissemination of new alphabets, languages and metaphors of content management and interaction which can be recognized and accepted as a helpful approach both in interpretation and communication processes.

How technologies and VR systems can develop the integration and interaction of cultural datasets often disseminated in many different archives? How can they support the interpretation, simulation of hypothesis? How can we share and exchange data? How can we make a model or a reconstruction “transparent”? That means how we can process in a virtual environment all the previous complex processes of interpretation, comparison, interrelation made combining bottom up and top down approaches (Forte, Pescarin, Pietroni, 2006). A VR domain should be a simulation environment where to test advanced behaviors, actions and new methodologies. It could be conceived as an open laboratory: a place where it is possible to compare the construction and validation of interpretative processes, to investigate new relations among data in space and time, to establish affordances (Gibson, 1979) in the interactive ecosystem. The digital ecosystem is an enhanced domain characterized by “biodiversity”, where users are embodied and the research of meanings depends on their capacity to observe, interpret, verify, validate, understand relations. The capacity of learning is based on informative exchange between users and ecosystem where mind and body, interaction, behaviours, feedback, are fundamental steps for generating information. Perception, information, knowledge are linked and interrelated in a process developing through the identification of multidimensional relations (Bateson, 1979). In a virtual environment the perceptive realism enhances the sense of presence and embodiment, it catalyses information that otherwise could be not be perceived.

2.2 The project

On the basis of these considerations, it is very important to create new virtual reality systems able to interact and connect with complex and multidimensional-multiscale data. This simulation space represents a new challenge for collaborative environments in archaeology (Forte, 2008).

The FIRB (Funds for the Investments of Basic Research) project, “Integrated Technologies of robotics and virtual environment in archaeology”, financed by the Italian Ministry of the University and Scientific Research, gives us the opportunity to experiment and realize a multi-user domain on the web addressed to a multidisciplinary scientific community. The project, in collaboration with the Department of Archaeology of the University of Pisa and with Scuola S. Anna of Pisa, focuses on three archaeological sites: the Teban tomb 14 in the necropolis of Gurna-Luxor, the Temple A of Middle Kingdom in Fayum Medinet Madi, both in Egypt, and the ancient settlement of *Khor Rori*, in Oman. These three sites present very different characteristics and interpretative aspects. The tomb TT14 is a small and narrow space with a very complex stratigraphy (micro-intra site); the Temple A is a well preserved architectonic context (macro intra-site); Khor Rori is a typical example of archaeological landscape correlated with environmental studies (macro inter-sites). We have expressly distinguished and emphasized these features of all the archaeological contexts in order to apply different methods of communications and virtual re-contextualization. This variety of conditions of the archaeological contexts has required the use of different integrated technologies of data acquisition, elaboration and representation: scanner laser, computer vision and topographic relief for TT14 (Figure.1), GPS, total laser station, GIS, remote sensing, photogrammetry, computer vision, 3D panorama for the settlement and the landscape of Khor Rori (Figure. 2), 3D computer graphics on the base of topographical relief for the Temple A of Medinet Madi (Figure 3).



Figure 1: Teban Tomb TT14, Gurna_Luxor, Egypt 3D model from laser scanner data

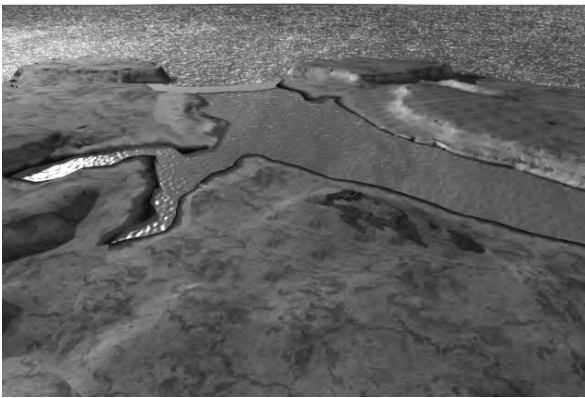

Figure 2: the landscape and the site of Khor Rori, Oman, obtained from topographic and CAD data, cartography, photogrammetry techniques.

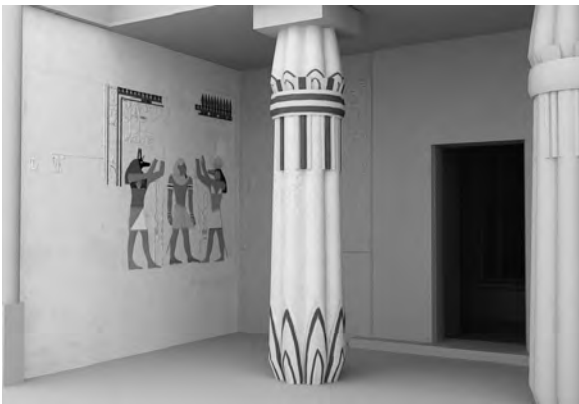

Figure 3: the Temple A of Middle Kingdom, Medinet Madi, Egypt; 3D reconstruction, realized from CAD data, with hypothetical mapping of original colors (author: Nicolò Dell'Unto).

Metadata, interpretative layers, multimedia contents are linked to 3D models and integrated in the three-dimensional space. All data converge in a virtual scenario in the web where the scientific community can meet and interact in real time, exchange and test hypothesis, share data and simulate different scenarios in order to discuss possible interpretations and

methods. This virtual space will be an editable and dynamic environment in continuous evolution and able to be updated with new databases.

3D models can be disassembled and recombined according to different combinations and solutions; they can be linked to new metadata, multimedia contents, Web pages. The continuous feedback of users updates, develops, redefines the “interpretative model” and the cognitive map of the context, opening new relations and perspectives. Different hypotheses corresponding to the “possible realities” can coexist, showing the reconstruction of the past through an articulated simulation process.

2.3 Interface and tools

Beside the 3D models of architectures and archaeological structures, obtained from topographical reliefs, the VR application introduces other kinds of ontologies expressing affordances/relations.

Cybermap: a symbolic space constructed through an abstract code, simplified geometries and colours; this non iconographic space represents the network of the informative system. The cybermap allows to verify and visualize the conceptual “map” of the virtual system. As we have explained before, the 3D space is the main interface of the informative system, where the community is embodied.

For this reason the construction of the 3D environment has not to become an obstacle for scientific communities that have not technical skills. The cybermap can be thus an opportunity to create simple conceptual maps for visualizing and representing interpretative solutions or hypotheses and discussing them within the community.

The map is constructed around “key concepts” that are the main attractors of the cultural themes or of the interpretative proposal. The network includes, around the “key concepts”, linked metadata: (texts, video, audios, sounds, images, multimedia), 3D models, that can be associated to the main key concepts. This network depends from our interpretative process: according to the kind of relations we want to establish among objects, the map changes (chronology, typology, topography, symbology, hierarchy...). Registered users can edit or re-create the cybermap organizing nodes and key concepts according to different relations (topography, chronology, symbolic value, hierarchy, shape, and so on).

Learning objects: they are the hyperlinks of 3D models and allow to access to other 3D models, or metadata (texts, photos, movies, htm pages).

Virtual Library: an imaginary cyberspace, like an island, where the users can find digital libraries, papers, multimedia contents related to the archaeological site and studies.

Simulations: dynamic scenarios (movies or animations) visualizing complex phenomena in the virtual ecosystem. We have planned to have two types of users, with different rights:

- Main users: teams involved in the FIRB projects, scientific community.
- Other users: general public with only some kinds of data accessible and no possibility to edit the scene.

All users can load in the 3D view single objects or a complete scene. An object file corresponds usually to a 3D model associated to a text file where the names of the mesh, the material, the texture of the objects and its link to any kinds of metadata are listed.

A scene file is a text file describing a complete scenario including 3D models, learning objects, links to metadata, simulations and all the components created by the author of the scene.

In the virtual scenario users are represented by avatars: they can chat, share objectives, actions, edit the scene or observe in real time the behaviours of other users. They can also add new objects, models, scenes in the repository hosted on the server, or they can edit existing objects and scenes, saving them, with another name, in the same repository. When a user saves a new scene he/she generates a text file containing a list of all the components. This text file will be read when the scene will be opened and the datasets will be loaded dynamically. Some editing tools are available to modify existing objects and scenes. These are the main functions and tools of the applications (Figure 4):



Figure 4: interface of the application

- Set project path: at the begin of the session the users have to indicate the url from which all the data will be loaded.
- Load objects (wrl, 3ds, nmo)
- Load scene
- Load texture
- Save scene
- Objects list
- Textures list
- Scenes list
- Delete objects
- Delete scene
- Reset
- Switch to other views/cameras;
- Select object
- Hide/show object
- Scale objects
- Change texture of the object
- Set material color
- Import a vectorial layer
- Move lights
- Measure (line, perimeter, area)

- Create a primitive geometry (for cybermap);
- Create a camera
- Create a link to a metadata (web pages, movies, audio comments, texts, images...)
- Chat

Every new version of the virtual environment can be saved and uploaded on the web as a new “space” of the MuD, so that many different informative worlds can coexist and be compared in real time. The possibility to load, share and interact with data in the same spatial virtual environment can increase the level of learning and scientific communication; in this way the information become hyper-real and contextualized.

The application, developed in Virtools DEV and Virtools Mutiuser Pack, is still in progress and it will be concluded in Autumn 2008.

3. CONCLUSIONS: POSSIBLE SCENARIOS

This paper examines new theoretical, methodological and technological approaches to the post-modern virtual communities operating in the world of archaeological communication and interpretation.

A key problem in archaeology is that there is a strong gap between data capture and data accessibility, because there is a very few percentage of information really open, communicated and public. The separation-segmentation of information in different domains (linear texts, models, spaces, maps, taxonomies, etc.) decreases the level of knowledge and not validates the interpretation process. So the risk is to construct huge quantity of information free from any reliability and communication processes.

It is a big challenge for the future of ICT and for the field of virtual heritage to plan the possible guidelines of cultural communication, and it is quite urgent to discuss about methods, technologies and epistemologies.

Embodied virtual communities construct their identity, learning, perception and communication on the principle of enaction that is on the capacity to create knowledge and information through perception-action interaction in the environment. This shared knowledge constructs new differences and feedback, validates or criticizes models and cybernetic territories through simulation processes, creating unique opportunities of discussion and advanced forms of knowledge.

In addition, it will be interesting to study the social behaviours of scientists, teachers and students within the virtual space: see them interacting in 3D with spatial data, constructing cybermaps and landscapes. A possible scenario is the virtual classroom where the teacher can interact in 3D with the students, discussing about key features of the archaeological sites, interpretations and general overviews. Secondly, the students can directly build a scene of an archaeological context on the basis of the data available on line. So they can edit models and 3D spaces, link metadata and multimedia contents, discuss on research and methodologies. The final aim is to validate the interpretative and reconstructive process and to share all the activities with the rest of the community/classroom. The final result could be an open portal where the teacher can evaluate the result.

The application was developed on the three case studies of the FIRB project but it can be useful for any other cultural context. This kind of approach can be used also in the projection and in the design of museums, virtual and real, in order to test for instance the organization of the space and its "metrics", the display of artefacts, the relation among objects, key concepts and meanings, communication platforms, paths of visit. Only after sessions of editing and simulation, the integrated project of communication could be published in a virtual museum or adopted in a real site (Figure.5) (Pietroni, Forte, 2006).

The most interesting perspective of this research project and innovative approach is in the redefinition of a virtual-cyber-archaeology as collaborative simulation process able to reconstruct the past through embodied communities of users/scientists. This distributed mind in the cyber space maybe represents the new frontier of our capacity of learning, understanding, communicating and transmitting culture.



Figure 5: an example of cybermap referred to the communication system inside an archaeological museum, attended by a virtual community (CNR-ITABC).

4. REFERENCES

References from Books:

Bateson, G., 1979. *Mind and Nature, a Necessary Unity*, Bantam Books 1979.

Bruner, J. (1968). *Processes of cognitive growth: Infancy*. Worcester, MA: Clark University Press.

Forte, M., 2008 (ed.). *La Villa di Livia, un percorso di ricerca di archeologia virtuale*, ed. Erma di Bretschneider, Roma.

Gerosa M., 2006. *Second life*, Meltemi, Rome.

Gibson J., 1979. *The Ecological Approach to Visual Perception*, Lawrence Erlbaum Associates. Hillsdale NJ.

Rheingold H., 2000. *The Virtual Community: Homesteading on the Electronic Frontier*, MIT Press, Cambridge, MA.

Varela F., Thompson E. - Rosch, E., 1991. *The Embodied Mind. Cognitive Science and Human Experience*, MIT Press, Cambridge.

References from Other Literature:

Benko, H., Ishak, E.W., Feiner, S., 2004. Collaborative Mixed Reality Visualization of an Archaeological Excavation. In: *The International Symposium on Mixed and Augmented Reality (ISMAR 2004)*, November 2004, pp.132-140.

Benko, H., Ishak, E.W., Feiner, S., 2005. Cross-Dimensional Gestural Interaction Techniques for Hybrid Immersive Environments. In: *Proc. IEEE Virtual Reality (VR 2005)*, Bonn, Germany. March 10–12, 2005. pp. 209–116.

Forte M., Pescarin S., Pietroni E, 2006. Transparency, interaction, communication and open source in Virtual Archaeology. In: *From Space to Place*, ed. BAR, II International Conference on Remote Sensing in Archaeology, 4-7 Dicembre 2006, Rome, pp.535-539.

Forte M., Pietroni E., 2006. The Museum's mind: a cybermap for cultural exhibitions. In: *The evolution of Information Communication Technology in Cultural Heritage*, ed. by M. Ioannides, D. Arnold, F. Nicolucci, K. Mania, VAST 2006, Nicosia, Cyprus 30 October – 4 November, pp70 -73

Maturana H., Varela. F., 1980. Autopoiesis and Cognition: The Realization of the Living. In: *Boston Studies in the Philosophy of Science*, ed. by Robert S. Cohen and Marx W. Wartofsky, vol. 42, Dordrecht (Holland): D. Reidel Publishing Co.

Mellet-d'Huart D., 2006. A Model of (En)Action to approach Embodiment: A Cornerstone for the Design of Virtual Environments for Learning. In WIN W. & HEDLEY N., Eds. *Journal of Virtual reality*, special issue on education. Springer London. Volume 10, Numbers 3-4 / December, 2006, pp. 253-269.

References from websites:

Jones Q. 2003. Applying Cyber-Archaeology. In: Proceedings of the eighth European Conference on Computer-Supported Cooperative Work, Helsinki, Finland, pp. 41 – 60. http://www.ecscw.org/2003/003Jones_ecscw03.pdf

Schroeder R., 1997. Networked Worlds: Social Aspects of Multi-User Virtual Reality Technology. In: *Sociological Research Online*, vol. 2, no. 4. <http://www.socresonline.org.uk/2/4/5.html>

5. ACKNOWLEDGEMENTS

We thank our colleagues of the Virtual Heritage Lab, CNR-ITABC, Nicolò dell'Unto, Claudio Rufa, Bartolomeo Trabassi for their fundamental collaboration in the FIRB project.

COLLABORATION NEED BETWEEN SOUTH AND NORTH KOREA FOR CULTURAL HERITAGE DIGITAL ARCHIVING

Hyuk-Jin Lee.

Texas Woman's University, School of Library and Information Studies, P.O. Box 425438, Denton, TX 76204-5438
hlee@mail.twu.edu

KEY WORDS: South Korea, North Korea, Cultural archetype, Digitization, Digital reservation, China.

ABSTRACT:

Digital archiving and restoration are two key solutions for the vulnerable ancient cultural heritage. Digitization makes it possible for a large number of otherwise fragile and hard-to-find historical materials accessible to the public. Archiving the cultural heritage from the ancient Korea is possible only through active collaboration across the political divide between South and North Korea. The collaborative efforts on digital archiving and restoration must also be extended to Chinese scholars in order to include the ancient Korean cultural heritage currently stored in China. This study not only points out urgent needs of collaborations but also reports the current status of Korean digital library projects and important aspects in a successful collaboration.

1. INTRODUCTION

Each year it becomes more important to archive the valuable cultural heritage (Lynch, 2002). We are opening the doors through digitization and making a great deal of fragile and hard-to-find materials available in digital form to people through the network (Crane & Wulfman, 2003). Especially, it is urgent to archive the ones from the ancient era carefully as they are fragile and vulnerable to any cause. Thanks to the rapid technology, geological location will no longer be a major barrier for preserving and accessing the cultural heritage collections in digital archiving. For example, there are active digital cultural heritage initiatives across regions such as Europe or North America (Zorich, 2003). However, there is a unique situation where such benefit does not work effectively. As known, Korea has been divided into South and North over fifty years for political issues; however, their cultural heritage should not be affected by such political aspects as both are sharing the identical history from the same ancestors. This study provides an analytical description of the current status, of digital archiving projects of Korean cultural heritage, especially for the period prior to Chosun (Joseon) dynasty (14th- 20th century). It identifies some major issues in the digital archiving efforts and concludes with the call for substantial collaboration between both Koreas to preserve Korean ancient cultural heritage.

2. THEORETICAL BACKGROUNDS

A digital library fulfills many of Choi's (1997) standards of ideal library such as: preservation of history and culture, easy user access, user-centered interfaces, improvement of life quality, functions for a community and culture of a community, and a service-oriented library. Tibbo developed a hybrid model of archive-library for digital library development by proposing the hybrid archive-library mixture of content that will be the digital library (2001). She explained that it is time to apply relevant aspects of both librarianship and archives, along with a strong technological base to the digital library's design and management (Tibbo, 2001). In the Korean context, the hybrid digital library includes both digitally-born materials and digital representations of physical material. Lee and Dalbello (2002)

explained that digital libraries are short-lived and institutionally unstable in the period of emergence, and therefore, they need the stability within institutional arrangements with stable resource base and political legitimacy. Digital library is crucial for ideal information society because a question to be dealt with first for information society is not only emphasizing on splendid digital information technology but also the contents of information infrastructure.

Cultural structuralist perspective (Turner 1989; 1991) roots cultural texts to the resource base from which they are able to emerge. Parsons (1977) observes that the information-energetic interchanges among action systems provide the potential for change within or between the action systems. Parsons proposed that the processes of evolution display the following elements: (1) Increasing differentiation of system units into patterns of functional interdependence; (2) Establishment of new principles and mechanisms of integration in differentiating systems; and (3) Increasing adaptive capacity of differentiated systems in their environments. Luhmann employs what he terms a general systems approach. Such an approach stresses the fact that human action becomes organized and structured into systems. When the actions of several people become interrelated, a social system can be said to exist (Turner, 1986). Wuthnow also portrays the processes of ideological production as increase in "ideological variation" that results in "competition" among ideologies (Turner, 1991). The institutionalization of an ideology depends upon the establishment of rituals and modes of communication affirming the new moral codes within an organizational arrangement that allows for ritual dramatization of new codes reducing uncertainty, that secures a stable resource base, and that eventually receives acceptance by political authority (Turner, 1991).

This study is based on these theoretical backgrounds. With the significant social and economical growth of the recent decades, the government of South Korea launched an information superhighway project in 1994 with the goal to extend national information capacity and foster multimedia information industry by 2015. Meanwhile, South and North Korea have been divided over half century and cultural gap between the two has been increasing. Collaboration on preserving, archiving, and serving the cultural heritage in both Koreas is one of the most important and urgent agenda as 1) it is important not just in

terms of archiving perspective but also in shortening the cultural gap between people in two Koreas, 2) the major territory that the ancient Korean cultural heritages exist is currently belonging to east northern China and such heritages are rapidly perishing due to lacking interest and collaboration, and 3) finally, such digital archive that will be achieved through collaborations will be significant resources in restoration of the cultural heritage in the near future. Among all the cultural heritages from approximately 5,000 years' Korean history, the periods that this study concentrates on is the heritages from the ancient era (Go-Chosun (Gojoseon); the first dynasty in Korea, B.C. 24th- B.C. 2nd century, and Three Kingdom period; B.C. 1st- A.D. 9th century) to the middle age (Koryo (Goryeo) Dynasty; 10th- 14th century) because they are more vulnerable and difficult to preserve. Moreover, more cultural heritage from Chosun (Joseon) Dynasty (14th- 20th century) have been digitally archived actively compared to the ones from above eras because Seoul, the capital of South Korea, was the capital of the dynasty and therefore, South Korea has been able to run the projects related to Chosun era alone relatively easily.

3. RELATED CULTURAL HERITAGE DIGITAL ARCHIVING PROJECTS IN SOUTH KOREA

Unlike many other countries such as the U.K. or Japan, the South Korean government was influenced by the first private digital library, LG Sangnam digital library (<http://www.lg.or.kr/index.jsp>), before starting the first government digital library project (Lee & Dalbello, 2002). This is one of the reasons why there have been many unorganized private digital libraries or cyber museum projects in South Korea. In South Korea there is a rather apparent distinction between the projects dealing with traditional library resources—mostly textual data, which is basically called, digital library, and the projects dealing with cultural heritage, which is called, digital museum. In this section, only the digitization projects that are related to cultural heritage excluding the traditional digital library projects are briefly introduced. They can be qualified as hybrid and non-hybrid that corresponds to a distinction made in policy documents, and as defined by Choi (1997). The hybrid project implies that the digital library/museum is an extension of a collection held in a physical institution. Documentation for each of the collections identified as 'hybrid' mentions links to materials for which they are digital surrogates; both digitally-born materials and digital representations of physical material. Non-hybrid projects include collections of links, portal sites and gateways to digital library sites.

Government Sector

Information Digitization Projects for Culture (<http://www.mcst.go.kr/english/index.jsp>, 1996 to 2008, Contents: Cultural science reference, Non-hybrid): this project was initiated by Korean Ministry of Culture and Tourism and it focuses on cultural resources from major museums and art galleries. A special service for cultural heritage for South and North Korea categorizes these collections by epoch, starting from Neolithic and including all the Korean dynasties; however, it does not include the major portion of North Korean cultural heritage yet and there has been no serious collaboration from the North side to develop this collection.

Presidential Commission for the New Millennium (August 1999- December 2000, Contents: Cultural heritage, Non-

hybrid): short-term projects that include cultural objects from the National Central Museum, major libraries, and art galleries.

Private Sector

Institute for Han Folk Cultural Study (Kyunghyang Press) (1997-1998, 2000-2001, Contents: Cultural heritage, Non-hybrid): this was the only initiative reflecting the possible collaboration between South and North Korea for sharing the cultural heritage. This project focused on North Korean cultural heritage, film, literature, and arts. Also, in the beginning stage it aimed at creating cyber museum of South and North Korean cultural heritage. However, there were practically no productive results.

Private / Government Sector

Culture-Net Project (1997 to date, Contents: Cultural heritage, Non-hybrid): it includes data from local libraries, museums and galleries, focusing on regional and local history collections. It is jointly sponsored by the Ministry of Culture and Tourism and Kyunghyang Press.

National Digital Library (<http://www.dlibrary.go.kr/>, 2002-2008, Contents: Cultural heritage, Hybrid): it is a collaborative initiative by the National Library of Korea to provide the information structure for unification of the currently distributed digital library network, from private museums, private and state-funded universities and government agencies. It was initiated by involving collaboration of five private institutes under the Korean government control: Library and Information Science Department at Yonsei University, Information Industrial Engineering Department at Yonsei University, Institute for Construction Science and Technology at Yonsei University, Samwoo Construction Company, and LG CNS. It is conceptualized as an infrastructure that represents a 'hybrid' library, the ideal form of digital library in Korea. NDL aims to open the real hybrid digital library in 2008.

4. MAIN ASPECTS FOR SUCCESSFUL COLLABORATION

4.1 Political and historical aspect

One of the major arguments of this research is that the digital preservation of cultural heritage should not be affected by the factors such as the political situation. Republic of Korea (South Korea) and Democratic People's Republic of Korea (North Korea) made a rapid progress in many aspects since the summit talk held in Pyongyang from 13th to 15th in June, 2000. Study of collection development policies for South-North Korean collaboration in response to South and North Korea talks was also held in Pyongyang in the same period for cultural heritage integration. In the report by Lee and Dalbello (2002), the projects that were specific to the Korean setting reflect unification trends at that time in which both government and private sector are involved in creating a cyber-museum of South and North Korea cultural heritage. So called, "Sunshine policy" (1998- 2002) by South Korea, which attempted to open the channels between South and North and supported and invested in North Korea, enabled the improvement of the relationships between the two regimes. Thanks to such a political atmosphere, there were much social and cultural collaboration between both sides. As a representative example, there was the cyber museum project called, Cultural Heritage of South-North Korea, which has been developed by ministry of culture and tourism since

1999. However, such cultural collaborations are diminished with the appearance of the new regime in 2008 as the policy towards North Korea is becoming stringent. It is important to separate the topics or the policies that may be or must not be influenced by such political mood; preservation of cultural heritage belongs to the latter. It often occurs that the relationship changes in cultural collaborations between different countries according to the change of political situation; however, the situation in the two Koreas is quite different. Even though the two Koreas have been divided for over fifty years, they share the same history with the same cultural heritage over thousands of years and the citizens of both countries understand that the current tragic division is the issue that should be solved (Jung, 2005). Even different countries that have different historical backgrounds or cultures often collaborate to preserve their cultural heritages. For example, Zorich (2003) introduced how the different cultural heritage organizations from different countries in North America are collaborating and standardizing the organizational alliances in many aspects including definitions, policy, and technology. Therefore, it is needless to say that the only divided country left in the world should consider doing so. To make a successful collaboration in preserving the cultural heritages, such collaboration must not be affected by the domestic political situation either; this must be regarded as a 'supraparty' topic, which all the parties should cooperate to make successful projects.

Finally, both Koreas should collaborate and investigate the status of the cultural heritage in the region of east northern China because this region was the main stage for the first dynasty in Korea called, Go-Chosun (Gojoseon) (see Figure 1), one of the Korean powerful dynasties, Koguryo (Goguryeo) (B.C. 1st- A.D. 7th century) in the Three Kingdom period (see Figure 2 and Figure 3) and its following dynasty, Balhae (7th-10th century). Gojoseon was an ancient Korean kingdom, considered the first kingdom of the Korean people. Go-, which distinguishes Gojoseon from the later Chosen (Joseon) Dynasty, means "Ancient". Gojoseon was founded in 2,333 B.C. by the legendary Dangun, said to be the grandson of Heaven (Lee, 2004). This kingdom was centered in the basins of the Liao and Taedong Rivers ruling over northern Korean peninsula and southern Manchuria, which is currently the east northern China (Hur, 2001; Lee, 2004). Archaeological evidence of Gojoseon is being found between the Jeulmun pottery to the Mumun pottery periods around 1,500 B.C., when groups of semi-sedentary small-scale agriculturalists occupied most of the Korean peninsula. Local bronze production began around the 8th century B.C. (Stark, 2005). Modern historians generally believe it developed into a powerful federation or kingdom between 7th and 4th centuries B.C. The name "Three Kingdoms" was used in the titles of Korean medieval history books, Samguk Sagi (12th century) and Samguk Yusa (13th century). The three kingdoms were founded after the fall of Gojoseon. After the fall of Gojoseon, the Chinese Han dynasty established four commanderies in northern parts of the Korean peninsula. Three fell quickly to the Samhan, and the last was destroyed by Goguryeo in 313 A.D. Samhan, the nascent precursors of Baekje and Silla, expanded within the web of complex chiefdoms during the Proto Three Kingdoms Period, and Goguryeo conquered neighboring Buyeo, Okjeo, Dongye, and other complex chiefdoms in northern Korea and Manchuria (Barnes, 2001; 2004; Rhee & Choi, 1992). The three polities made the transition from complex chiefdom to matured state-level societies in the 3rd century. All three kingdoms shared a similar culture and language (Rhee & Choi, 1992). Finally, Balhae (698- 926 A.D.) was an ancient multiethnic kingdom established after the fall of Goguryeo. After Goguryeo's capital

and southern territories fell to Unified Silla, Dae Jo-yeung, a former Goguryeo general, established Jin, later called Balhae, by uniting various Mohe and Goguryeo elements (Byington, 2004; Petrov, 2004). Balhae was a successor state to Goguryeo (Schmid, 1997; 2000). Balhae occupied southern parts of Manchuria (Northeast China) and Primorsky Krai, and the northern part of the Korean peninsula. It was defeated by the Khitans in 926 A.D., and most of its northern territories were absorbed into the Liao Dynasty while the southern parts were absorbed into Koryo (Goryeo) Dynasty, which is the origin of the word, Korea.

Considering such historical background and the importance of the region, collaboration project including digitization of cultural heritage of this region (southern Manchuria) among both Koreas and China is necessary. However, currently there has been no practical collaboration between the three countries and a rapid decay of the cultural heritage is apparent. Therefore, it is time to discuss the possible collaboration including digitization projects for cultural heritages in this region by the cultural heritage initiatives or organizations in East Asian countries similar to the cases in North America or Europe.

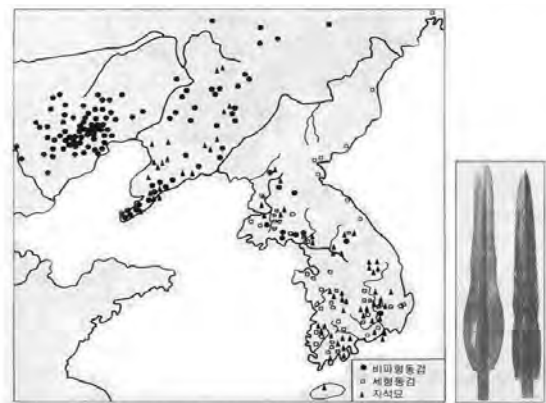

Figure 1: The distribution map of the mandolin-shaped dagger shows the possible extent of Gojoseon's influences of politics, military or culture.



Figure 2: The map of Three Kingdoms including Koguryo (Goguryeo).



Figure 3: A replica of a mural of one of the directional deities found in a Goguryeo Tomb at the National Museum of Korea.

4.2 Consistency and accessibility aspect

Even though the Information Digitization Projects for Culture (1996 to 2008) deals with North Korean cultural heritage, it has not involved a sufficient portion of the heritage from both Koreas, and there were only few attempts from either a government or a private sector to digitize both Korean's historic heritage. One of the problems in a digital archiving project in Korea is its consistency; most of the projects are rather short term and receive little attention when the project is over. For example, one of the most active project that attempted to include North Korean cultural heritage is Institute for Han Folk Cultural Study led by Kyunghyang Press lasted from 1997 to 1998 (1st period) and from 2000 to 2001 (2nd period). The project received much attention when it was launched but has since become unavailable to public access. There is not much difference in the cyber museum project initiated in 1999, Cultural Heritage of South-North Korea, which was mentioned in the previous section. While it is common for most digital archiving projects to be short term efforts, Parsons and Luhmann argue that no fruitful results could be expected without consistency and accessibility over time (Turner, 1989). Any digital archiving project for Korean cultural heritage can be successful only if the need for consistency and accessibility is guaranteed through collaborative efforts between two Koreas. Thus, it is an important agenda to make the results of such projects to be consistently accessible to the public and the press so that they are not treated and forgotten as a temporary project.

4.3 Technological aspect

The technology level in most digital archiving projects in South Korea is matured enough to lead a successful collaboration with the North. In a recent example, there were plenty of successful digitalizing projects for Korean cultural heritage including historical Buddhist civilization in 2003 and 2004 run by the specialized digital archive and restoration companies. In 2007, the famous old picture, Amitawhesang-do, in an ancient Korean Buddhist temple Baekyangsa, (www.baekyangsa.org) that was seriously damaged was successfully restored digitally by Korean HP (www.hp.co.kr) (see Figure 4). Expertise necessary to restore Korean ancient cultural heritage was evident for preserving the ancient Korean cultural heritage in a digital format (Do, 2007). Such specialized technology can be applied to digitize, preserve, and restore the ancient cultural heritage from both Koreas.



Figure 4: Amitawhesang-do in Baekyangsa (Baekyang Temple). Baekyangsa was built in 632 A.D. by Baekje kingdom, one of the three kingdoms in the Three Kingdom period, and Amitawhesang-do was drawn in mid-18th century.

5. DISCUSSION AND CONCLUSIONS

In conclusion, it is important that the cultural heritage preservation project based on collaboration between South and North Korea, and furthermore, including China, should not be interfered with their political situation. Such a factor should be minimized because preserving the cultural heritage is not just for our generation's benefit but for the generations to come. Thus, it is an urgent agenda for both Koreas to digitally preserve and share their cultural heritage especially from the ancient era to the middle age era.

There are sufficient interests and technology in digital archiving for preserving the cultural heritage in South Korea (see Appendix A). For example, the annual report by Korean Ministry of Culture and Tourism in 2006 and the annual report by the Commission of National Science Technology in 2008 indicate the importance of digital archiving project for cultural heritage and the financial support and technology by the government. However, there is still lack of interest on the collaboration with North Korea in such government reports. The necessity for investigating the cultural heritage in east northern region of China was reported in 2005 annual report by Korean Ministry of Culture and Tourism but there was practically no follow-up either. For a successful collaboration, successful cases in European countries should be referred to, where many neighboring countries that had complicated political issues have been collaborating for cultural studies; such cases will be investigated as a future study.

In Lee & Dalbello's study (2002), in South Korea it was observed that most main projects under the government control, a few national universities, and a small number of private universities with a foundation of solid finance, are rather established in terms of the budgets. However, most private universities and private institutes proved to short of funding. Therefore, it would be more stable and ideal for a government

to play the lead for such collaborative project. For example, National Digital Library (NDL) project, the representative hybrid digital library in South Korea opening in 2008, could take a major role in addressing such necessity and leading the projects. The annual report by Korean Ministry of Culture and Tourism in 2006 indicated the agenda for excavating and investigating the cultural heritages by collaborating with China and Russia. However, there have been no practical outcomes up to date and the report did not point out the aspect of digital archiving of the cultural heritage. Therefore, the future study will cover the status of the outcomes by the government institutes regarding such topics. Then, the substantial framework or project will be suggested to involve the NDL project actively in digital archiving collaboration among the two Koreas and China. As mentioned before, a few successful cases or models among the European countries will also be investigated and referred to in order to implement such a project effectively.

The digital museum managed by both Koreas may not only preserve their valueless cultural heritage but also be an effective medium to quench the people's curiosity of each other and shorten the cultural gap between the two. And finally this will offer the priceless resources to restore their cultural heritage in the future.

6. REFERENCES

References from Journals:

Barnes, G. L., 2004. The emergence and expansion of Silla from an archaeological perspective. *Korean Studies*, 28, pp. 15-48.

Best, J. W., 2003. Buddhism and polity in early sixth-century Paekche. *Korean Studies*, 26(2), pp.165-215.

Choi, S. H., 1997. Digitalization of libraries in advanced information society. *Journal of Information Society*, 4(4), pp. 126-167.

Han, C. G. 2002. Trend and perspective of Korean prehistoric study in North Korea. *Journal of Society for Korean Ancient History*, 25, pp. 5-27.

Jung, J. W., 2005. Analysis on the negative and positive factors for the neutral unification of the Korean peninsular. *Journal of North Korea Study*, 9(2), pp. 171-195.

Lynch, C., 2002. Digital collections, digital libraries & the digitization of cultural heritage information. *Microform & Imaging Review*, 31(4), pp. 131-145.

Petrov, L. A., 2004. Restoring the glorious past: North Korean Juche historiography and Goguryeo. *The Review of Korean Studies*, 7 (3), pp. 231-252.

Rhee, S. N. & Choi, M. L., 1992. Emergence of complex society in Korea. *Journal of World Prehistory*, 6(1), pp. 89-91.

Schmid, A., 1997. Rediscovering Manchuria: Sin Ch'aeho and the politics of territorial history in Korea. *The Journal of Asian Studies*, 56(1), pp. 30.

Schmid, A., 2000. Looking north toward Manchuria. *The South Atlantic Quarterly*, 99(1), pp. 219-240.

Tibbo, H. R., 2001. Archival perspectives on the emerging digital library. *Communications of the ACM*, 44(5), pp. 69-70.

References from Books:

Barnes, G. L., 2001. *State Formation in Korea: Historical and Archaeological Perspectives*. Surrey: Curzon, Richmond.

Hur, J. H., 2001. *An Introduction to Gojoseon History*. Institute of Social Academy Press, Seoul.

Parsons, T., 1977. *Social Systems and the Evolution of Action Theory*. The Free Press and Collier Macmillan, New York and London.

Stark, M. T., 2005. *Archaeology of Asia*. Blackwell Publishing, Oxford.

Turner, J. H., 1989. *The Structure of Sociological Theory*. The Dorsey Press, Chicago.

Turner, J. H., 1991. *Cultural Structuralism; Robert Wuthnow and Pierre Bourdieu. In the Structure of Sociological Theory*. Wadsworth Publishing, Belmont, CA, pp. 500-518.

References from Other Literature:

Crane, G. & Wulfman, C., 2003. Towards a cultural heritage digital library. In: *Proceedings of Proceedings of the 3rd ACM/IEEE-CS Joint Conference on Digital Libraries*, Houston, Texas, pp. 75-86.

Lee, H. J. & Dalbello, M., 2002. Digital library projects and initiatives for cultural heritage in Korea. Poster presented in: *Research and Advanced Technology for Digital Libraries 6th European Conference, ECDL 2002*, Rome, Italy.

Lee, J., 2004. *The Relatedness between the Origin of Japanese and Korean Ethnicity*. Doctoral Dissertation, The Florida State University, Tallahassee, FL, USA.

Zorich, D. M., 2003. A survey of digital cultural heritage initiatives and their sustainability concerns: managing economic challenges. Report CLIR, Washington, D.C., USA.

References from websites:

Byington, M., 2004. Article of History News Network at George Mason University "The War of Words between South Korea and China over an Ancient Kingdom: Why Both Sides are Misguided", USA. <http://hnn.us/articles/7077.html> (accessed 15 May 2008)

Do, A. G., 2007. Korean IT News "Restoration of Amitawhesang-do", Korea. <http://bloter.net/tt/eyeball/667> (accessed 12 May 2008)

**APPENDIX A. EXAMPLES OF DIGITAL ARCHIVE
WEB-SITES IN SOUTH KOREA**

Academy of Korean History:

<http://yoksa.aks.ac.kr/>

Cyber Museum of Baekjae History: <http://baekje.chungnam.net/>

Korean History Online:

<http://www.koreanhistory.or.kr/>

Korea Knowledge Portal:

<http://www.knowledge.go.kr/main.jsp>

Korea National Heritage Online:

<http://www.heritage.go.kr/index.jsp>

National Digital Library:

<http://www.dlibrary.go.kr/>

National Folk Museum:

http://www.nfm.go.kr/data/d0_bri.jsp

INTEGRATION OF HIGH-RESOLUTION TILED PYRAMIDAL TIFF IMAGES OF OLD GLASS NEGATIVES IN AN ONLINE PHOTO LIBRARY FOR CONSULTATION, RESEARCH AND CONSERVATION.

E. Buelinckx*, H. Opstaele

Royal Institute for Cultural heritage, Brussels, Belgium - (erik.buelinckx, hans.opstaele)@kikirpa.be

KEY WORDS: high-resolution photography, restoration, conservation, glass negatives, open source backup & recovery system, version control

ABSTRACT:

The Royal Institute for Cultural Heritage of Belgium has most of its rich photo library of art objects online for free consultation for researchers and the general public. Scientific research of details, when not separately photographed, is difficult. Therefore we searched on how to make the quality of our professional photographs online available in full without taking the risk of illegal copying. We use open source technologies like IIPImage (open source light-weight client-server system for the remote viewing of very high-resolution images), combined with the in-house developed artiPACS (art in a Picture Archive Communication System), an extension of some workhorses of the open-source Internet community. Subversion (version control system), used in program development and documentation writing, and ftp are combined to record the whereabouts and state of the digital object throughout its history and to maintain alternate versions and updates of an object over time. The ISLA Broker (Image-Search-Library-Assistant) then takes care of the translation between this machine-level archive and the human way of dealing with objects. It represents the archive as a searchable and interconnected “web of collections” that provides documentation, authentication and naming, and maintains an overview over all collections. As a case study large glass negatives (40 x 40 cm) of old photos were photographed in the institute with a high-resolution camera and saved in raw (with all the information) and a corrected tiff format. This tiff file can be converted to a tiled pyramidal tiff format, to offer different types of users, internal and external, the possibility of zooming in.

1. INTRODUCTION

The Royal Institute for Cultural Heritage of Belgium has as one of its official duties, to create, maintain and disseminate a photographic inventory of artistic objects in Belgium, and where possible of objects made by Belgians in other countries. Belgium, as used for this task, must be understood as the geographical surface of the current country throughout history. For the moment the institute has the original negatives of almost 1.000.000 photos about artistic objects. More than 600.000 photos of over 370.000 object descriptions, with their iconographic and documentary information, are already open to consultation on www.kikirpa.be, where the low-resolution images can be viewed. But as a further service we would like to offer high-resolution zoomable images on view for as well the general public as the more exigent researcher. Partly involved in a project where a special scanner will be build for the scanning of glass plates and film, we still needed to find a way to digitize the large format glass negatives (40x40 cm), which would not fit on the scanner. As an institute specialized in photography for many decades, we opted for high-resolution digital photography. But then, as expected beforehand, the problem was how to handle all those newly generated large files.

2. DIGITAL PHOTOGRAHY OF GLASS NEGATIVES

2.1 Test material

As a test case for this project we took from our own collection 532 large glass negatives (40x40 cm) of art objects (mostly

buildings) and did in-house photographing on a self-build light case. These plates date from the first WW. High-resolution photographing of each plate generated three files:

- RAW: negative, RGB, 16 bit, 300 dpi, 40x40 cm around 130 Mb;
- TIFF: positive, greyscale, 16 bit, 300 dpi, 40x40 cm, small retouches (dust and in separate layers contrast), from 60 to 220 Mb (depending on number of added layers);
- JPEG compressed: greyscale, 8 bit, 300 dpi, 40x40 cm, from 4 to 12 Mb depending on image.

2.2 Problems and proposed solutions

During the manipulation of the plates, notes were taken about the state of the plates for future restoration and conservation. Problems with plates could be: emulsion loosening, corners broken, paper or tape glued on plate, scratches or spots, colouring, holes in emulsion, air bubbles between glass and emulsion, missing parts filled up with gouache. The plates were cleaned with demineralised water before photography. After photographing them the emulsion was gently cleaned with ethanol. The glass negatives were then stored in a new cover with on the inside acid-free paper, and on the outside 100% cotton, mould-made, acid free paper. Unfortunately our budget doesn't permit us to use new cardboard boxes for storing the plates, so for the time being the old ones were thoroughly cleaned, but since they contained traces of mould, they should be replaced as soon as possible.

Another important problem generated by this project is the large amount of data storage needed for archiving and easy

* Corresponding author.

manipulation of these digital images. The scanning alone of these 532 negatives, and the storing of the three formats, took up some 150 GB. Manipulation of the images to create pyramidal tiffs for the website or other formats for specific demands of the public are not counted in yet. And the institute has almost 1.000.000 negatives. To be able to keep such a large mass of data under control, a system was needed that met the demands regarding usage and life-long storage.

3. ARTIPACS

The artiPACS (Art in a Picture Archive and Communication System) is an in-house developed digital picture archive. Being proponents of the widespread use of open source technologies, we opted to make use and extend some of the workhorses of the open-source Internet Community for our new archive, artiPACS an open-source initiative under the GNU GPL-license.

3.1 A hands-on example of artiPACS

Throughout this article, an example is used to clarify the theory, procedure and pitfalls during archiving. The example contains three collections XOLD, XNEW and XRAW found on a hard drive in our photo studio. The table below specifies the size and file count (table 1).

Collection	XOLD	XNEW	XRAW
Picture count	4611	12274	10375
Size (GB)	21	63	118

Table 1: Hands-on example.

All folders have images with similar names X0123, X111L, X0004, X001, X00005L, ... One or more digits, followed by an optional 'L' character, follow the letter 'X'.

Each filename has an extension: TIF, TIFF, CR2, REF, TAF, RAW, JPG. The latter (JPG) is a processed image where brightness, contrast, canvas size or another property has been edited. The other extensions indicate a raw, unprocessed, picture.

Any of the three collections may contain the same file (minus extension). For example: image X123 may be present in XOLD as X123.JPG, in XNEW as X123.JPG and in XRAW as X123.RAW. These are three different versions of one image and will be referred together.

3.2 Preparations before uploading: the broker

Before uploading a collection, we must prepare the broker. The broker acts as the collection watchdog: it verifies the naming conventions of a collection and manages the relations between other collections. The broker can also fetch a file, a thumbnail or data related to a collection via a simple web-query.

For our example, we've called the new collection simply 'X'. This collection is related to the 'PHOTO' and 'ADLIB' collection in the institute. The full path, starting from the root is '/ADLIB/PHOTO/X' (figure 2). This path can be used to store information related to the collection on a shared network folder. With a small tool, we can import the broker into graph

visualization tools like TULIP (www.tulip-software.org) (figures 2 and 3).

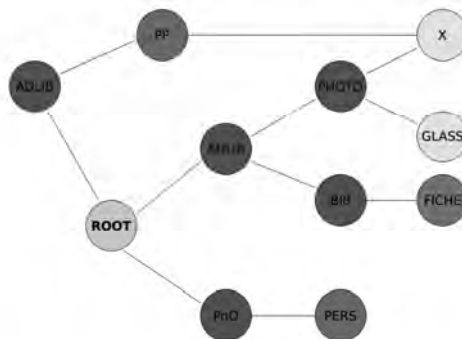

Figure 2: TULIP-generated view (re-worked for print clarity)

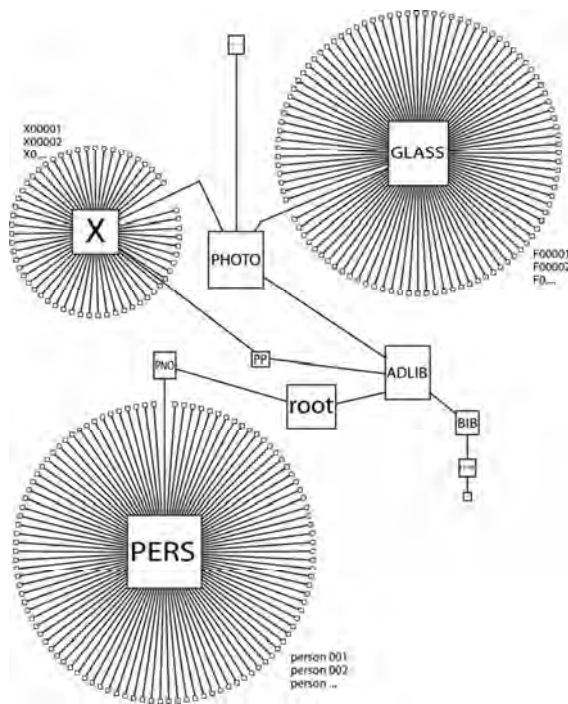

Figure 3: TULIP-generated view (re-worked for print clarity)

A strong naming convention will prevent the archive from getting dirty and inconsistent. Even the best archiver can get distracted and errors will occur. The broker triggers an error if one would upload a file to the wrong collection or, for example, upload the same image twice under different names.

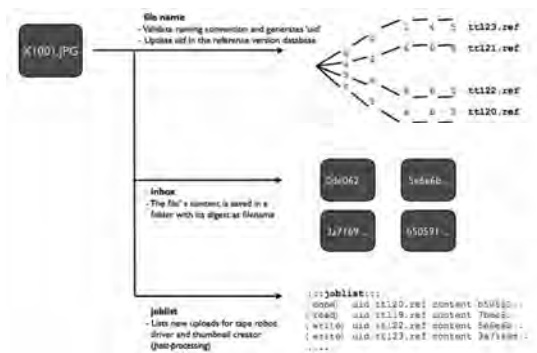

Figure 4: Functionality of the ftp patch

The naming convention uses regular expressions to check for typing mistakes. The regular expression for our X collection is $^X[0-9]+L?\$$. In plain English, this reads: “Start with an ‘X’ followed by one or more numbers and end with an optional ‘L’ character”.

Next, an optional logo is chosen. This logo represents the collection and is, besides being handy for presentations, used to quickly identify the collection when browsing the broker.

As seen in table 5, left column, the tt107 reference is used. This reference is a picture of a green monster (figure 11), used for undefined references in the archive or things that were not clear at that time to the archive administrator (it even became a member of our personnel photo collection and thus a member of our permanent staff).

Security, the last field of table 5 is used to protect copyright infringements but was not yet implemented at the time of writing.

Section	Parent	Grandparent	Naming convention	Security
ADLIB	root			n/a
PHOTO	ADLIB	root		...
X	PHOTO	ADLIB		...
tt107	X	PHOTO		...
X1001	X	PHOTO		...
tt123	X1001	X		...
...

Table 5: Construction of paths

Table 5 shows some relevant records of the X photo collection. The first three rows describe the path of the collection in the broker. Next, the X collection is defined with the naming convention, section logo and security described above. This record is called the section leader.

The two light grey rows are automatically generated for each new element in the archive.

Each new image maps its original name (UPPERCASE) to an internal universal-identifier or uid. A uid is a computer-generated identifier used to replace the human understandable name: the reason is to protect the algorithms down the road from too much human intervention:

Unforeseen changes in naming conventions or the use of foreign characters in names (like é, ç, à) can cause very annoying problems.

The lowercase and uppercase convention is a practice commonly used by C-programmers. The use of lowercase indicates objects that exist in reality (tt107 is a physical file). Uppercase names refer to defined database structure in the broker.

Not all collections must be stored in the broker database. Some collections are not of a permanent nature (e.g. photos of the employees). A simple section leader then suffices. The photos itself can be stored in the thumbnail database (later) or as related information shared folder on the server. When accessing such virtual collection, the broker will detect this and trigger a script to obtain the photos from an alternative location. These scripts are typically small, customized perl-scripts (www.perl.org). This way, an artiPACS photo can also be a website URL or even a complex database query.

3.3 Uploading a collection to the archive

The archive works decentralized: files are not stored on a central server but must be committed when the photographer has finished his or her work. The reason for this is performance. Since digital media are becoming bigger, the chance of overloading a server or network is realistic. Neither network nor server may become a bottleneck and the photo studio must be able to continue working if the system or network should fail. Uploading uses an extension to the FTP protocol. We opted for FTP because it is open and widely implemented and offers advanced features like quota control, authentication and SSL security. The product used here is the open-source pure-ftp server (www.pureftpd.org). For the FTP client, we used python (www.python.org) to have better portability across Linux, Mac and PC and a faster turn-around time. Script based programs allow fast in-situ changes.

3.4 About names, content and post-processing

Another basic design choice is to separate name and content of a file. When working with multi-version files there is no longer a one-to-one relationship between a file and its name.

To avoid confusion, we will use the terms reference instead of filename in this article. Unlike a filename, a single reference can point to one or more images.

Another reason is the way in which tape systems work. A file is actually defined as a location, a block-id, on a tape-volume between two file-markers. If we need to verify whether a file from the tape is actually the requested data, we need to have a fingerprint of the byte-to-byte content of the data. This fingerprint algorithm, the digest, is at the very heart of our archive.

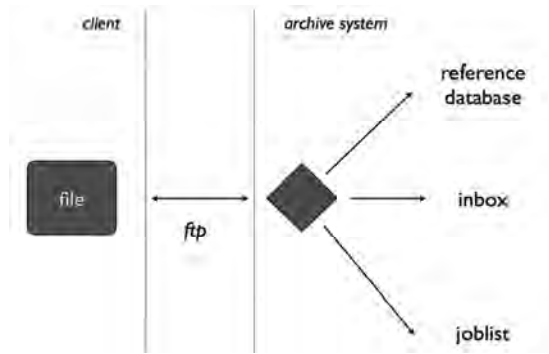

Figure 6: Uploading a file

Figure 6 illustrates how uploading a file works. A file is uploaded via FTP. Because the artiPACS ftp-server is patched, the ‘RNT0’ FTP command triggers our algorithm that splits a normal file in its content, its reference and an action on the job list to mark the newcomer.

The job list is used for several other actions: generating a thumbnail, storing it on tape cartridges, etc. This is called the post-processing phase.

3.5 How content can be referred to without a filename

When we disconnect the notions of content and filename, we need another method for defining equality and inequality of data. File ‘X’ and file ‘Y’ are no longer different just because their filename is different and, in reverse, two uploaded files ‘X’ can be different versions of one file (e.g. a raw camera image and an image with adjusted contrast levels).

Our archive uses the crypto-mathematical MD5 digest. A digest, also known as ‘one-way hash function, of data X is defined as [Schneier 1996, ch. 18]:

A one-way hash function, H(M), operates on an arbitrary-length message M (the data). It returns a fixed-length value, h.

$$h = H(M) \text{ where } h \text{ is of length } m$$

With characteristics that make them one-way:

- Given M, it is easy to compute h
- Given h, it is hard to compute M such that H(M)=h.
- Given M, it is hard to find another message M’, such that H(M)=H(M’)

The whole point of the one-way hash or digest is to provide a fingerprint of data. In practice the digest is a 32 characters long word made from letters and numbers: (e.g. d34c37c163358084e32958b8d8cb6300)

3.6 The reference database

Before a file is uploaded, the broker checks the filename to see if it is valid. If this is ok, a ‘uid’ (or reference name) is created in the broker database. Table 7 displays how much pictures have a bad naming convention in our example, despite careful screening!

	XOLD	XNEW	XRAW
Files in the collection	4611	12274	10375

File formats not allowed: TIF, TIFF, CR2, REF, TAF, RAW or .JPG	0	1	40
File name not allowed	15	0	4
Total uploads	4596	12273	10331

Table 7: Results of screening naming convention

The reference file is a flat plain-text file. It contains a line per version it refers to. If this file is new, then a file is created in the version database with the digest of the file’s content as a single line. If the file would already exist, the uploaded file is considered as a version and the digest is appended to the existing reference file.

Below is an example of a reference file with two versions. The original filename is stored next to the digest.

```
file: tt123.ref
3a7169d1994f86281158941c78cc11ae
name:X1001.JPG
d34c37c163358084e32958b8d8cb6300
name:X1001.RAW
```

The reference database is a flat set of .ref files (figure 8, right). But the set can grow very large. We use subversion as a tool to manage the files like a database. Subversion is a commonly used amongst software developers on the Internet (subversion.tigris.org). This freely available tool enables us to maintain a set of files and see every change made, why a change was made, who made a change, and it can add meta-data to files or group related files together. This last option is useful to specify collages. A bigger advantage is that the database looks like a normal file system. Even if the subversion system should fail or no longer exist in the future, the reference database, critical to the artiPACS archive, can survive.

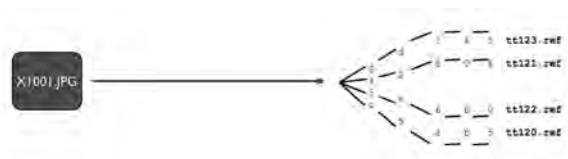

Figure 8: Uploading a file.

In figure 8 the file X1001.JPG was uploaded. Its extension .JPG was chopped and the broker has verified the filename with the naming convention. It then translates X1001 to reference tt123.ref. This conversion is based on the broker’s database. If the file already exists, the broker retrieves it from its database, if not, the reference is generated by incrementing a counter.

In the middle of figure 8 are the shards. Because there can be more than 1 million reference files, it would be impractical to store all reference files in one folder. We subdivide the folders in a transparent, automated way. But the folders also have to be balanced. On average, all folders must contain an equal amount of files. The shard algorithm uses again the MD5 hash function on the filename to provide a balanced folder structure.

The MD5 of the reference is used to create the shard: MD5(“tt123.ref”) = 0d1455e062d..., so the folder to place the file tt123.ref in is 0/D/1/4/5/. This technique works because a

MD5 hash changes drastically with even a minor change in the file's name and the folder will stay balanced this way.

3.7 Duplicates and collisions in the inbox

The inbox is a simple folder to store the uploaded files before they are processed (thumbnail, put on tape, etc.). But, because this is a multi-version archive we cannot allow the files to keep their name. If two different versions of file X1001.JPG would be uploaded, they would overwrite each other and we would lose data.

To solve this problem, we rename the file to the digest of its content. For example: the digest of the content of file X1001.JPG is "c37cd122163358084e32958b8d8cb6300", so the file in the inbox folder is simply named this way. Since the tape system is ignorant concerning filenames, this way of working is quite useful: if ever a file on tape is found without knowing what it's supposed to represent, a simple search can reveal the corresponding reference, the original filename and even its entire history in the logbooks of the version database.

Another advantage is that it is easy to detect picture duplicates. Duplicates are files in a collection stored under a different name. If both files X123 and X144 exist, but they are of an identical image, then this is called a duplicate. This happens quite frequently in practice.

One warning about this method: the success of finding duplicates with a digest depends on the quality of the digest function. A bad digest can generate the same hash code for different pictures! Since MD5 is well known and widely used, we can rest assured that those digest collisions have a probability of 2^{-128} . If a supercomputer would archive 1.000.000 files per second, it would take an average 3.600.000.000 years to have a collision [Schneier 1996, ch. 7, p. 166].

Duplicates and collision can easily be checked: the number of uploads do not match the number of files in the inbox. See table below for the duplicates in our real-life example.

INBOX	XNEW	XOLD	XRAW
# uploaded files	4596	12273	10331
Duplicates in a collection	7	25	40
Cross collection duplicates	0	0	12
Collisions	0	0	0
Total files	4589	12248	10279

Table 9. Duplicates and collisions

3.8 The post-processing phase

Post-processing is a vital part of archiving. Without post-processing the files would accumulate on the server's hard-drives and these would need electrical power to sustain, because hard-drives tend to leak information when not powered for a long time. [Curtis Preston 2007]

The post-processing list is actually a serialized list of actions, needed to support concurrent access to the system: many people may need to store and retrieve photos at the same time, but the tape subsystem can only handle one request at a time.

Serialization takes care of that problem. It can be compared to a ticket system in a bakery.

After successful tape archiving, the corresponding reference is updated with the location of the file's content on tape. Below is an example of a file reference referring to tape.

```
file: tt123.ref
3a7169d1994f86281158941c78cc11ae
  name:X1001.JPG
  vol:WMP010
  blockid:87
d34c37c163358084e32958b8d8cb6300
  name:X1001.RAW
  vol:WMP010
  blockid:215887
```

Further details of the tape subsystem and thumbnail management are considered outside the scope of this article.

4. INTEGRATION WITH EXISTING SYSTEM

4.1 Obtaining pictures from the broker

The ISLA broker can be accessed via simple HTTP 'GET' requests. A GET request is indistinguishable from a normal web address, except for a question mark and ampersand characters, used to send parameters. We use this system because HTTP is an open specification and can be easily integrated in meta-data databases like the library and museum system we use.

To obtain thumbnail of UID:

```
http://isla.kikirpa.be/cgi-bin/tlb.pl?obj=tt107
```

To obtain a full report on the whereabouts (server, state meta-data), version logs and thumbnail of object X1001 in the X collection as a formatted webpage:

```
http://isla.kikirpa.be/cgi-bin/tlb.pl?obj=X/X100&meta=all
```

More details about the functionality are listed in table 10. The broker can also be browsed as a website (figure 11 & 12).

makeuid	Verify the naming convention for a given collection and convert the name to a UID.
uid	Convert human name to UID.
docs	Get a list of related document on the shared network folder.
paths	List paths, starting from 'root' in the broker network.
all	Create a full report about state, version history in the version database.
syn	Synonyms of the image.
hi-res&password=abc...	Request a hi-res picture from the tape subsystem

Table 10: Functionality of the broker

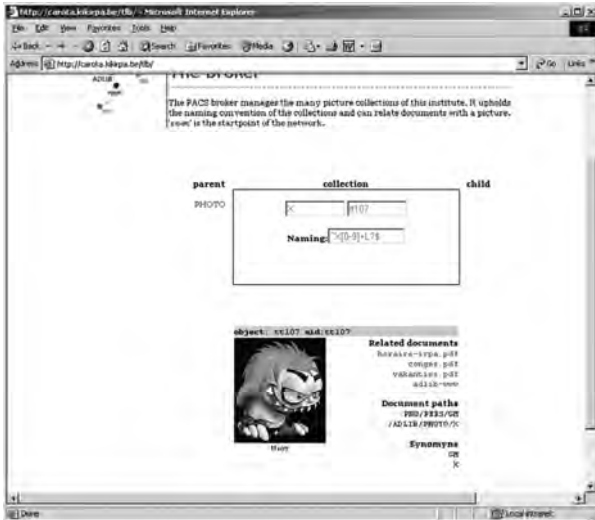

Figure 11: ISLA Broker screen

One remark on synonyms: this reveals a basic property of our broker. The broker is in fact a none-hierarchical file system, a network of collections and pictures instead of the more usual tree-like structure. In fact, it's possible to link one image to one or more collections! An example is the green monster used when no image is available in our archive (figure 11).

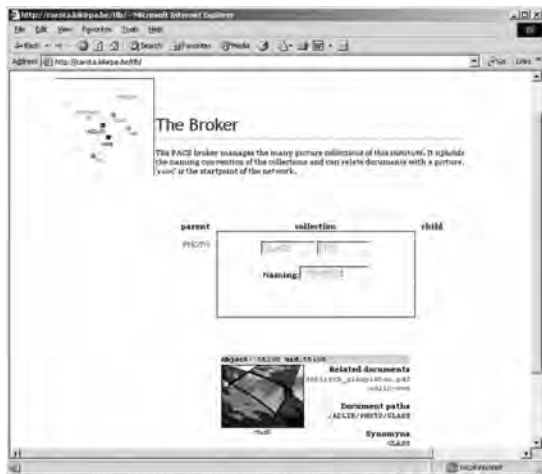

Figure 12: ISLA Broker screen

5. CONCLUSION

As a small governmental institute with a large collection of photographs to be digitized and archived we prefer to use open source software and develop in-house. Putting these practices to work and making the knowledge from this project available via the open source community will hopefully bring us useful improvements and networking possibilities. We are open to anybody wishing to contribute or make use of this system still under development.

6. REFERENCES

6.1 References from books

Curtis Preston, W., 2007. *Backup and Recovery*. O'Reilly, Sebastopol.

Mason, M., 2006, *Pragmatic Version Control Using Subversion 1.3, 2nd ed.*, O'Reilly, Sebastopol.

Schneier, B., 1996. *Applied Cryptography, 2nd ed.*, John Wiley & Sons, New York.

Digital Museums and Libraries

THE CURRENTLY FEASIBILITY OF CONSERVATION CONCEPT

S.K. Nassar, S.S. Abdalla

Associate Professor, Architecture Department, MUST University. 6 October Cairo, Egypt, samianassar@hotmail.com
Lecturer, Architecture & Housing Department, Housing and Building Research Center, 87 Tahrir Street, Cairo, Egypt
saharsoliman99@hotmail.com

KEY WORDS: Conservation, Urban Conservation, Culture Heritage, Sustainable Development, Historical sites, Landscaping.

ABSTRACT:

Conservation involves maintaining the presences of the past in present. It means prevention against change or deterioration of a building's fabric and the maintenance of its authentic character. It involves Preserving, Restoring and adapting old buildings designing new ones that respect the contexts. Conservation, Preservation, Renovation and maintenance are several approaches that deal with the buildings to upgrade and maintain the deterioration aspects. Architectural conservation deals with issues of prolonging the life and integrity of architectural materials, such as stone, brick, glass, metal, and wood. In this sense, the term refers to the "professional use of a combination of science, art, craft, and technology as a preservation tool and is allied with its parent field, art conservation. Preservation of the architectural heritage is considered a fundamental issue in the life of modern societies. In addition to their historical interest, cultural heritage buildings are valuable because they contribute significantly to the economy by providing key attractions in a context where tourism and leisure are major industries in the third millennium. The need of preserving historical constructions is thus not only a cultural requirement, but also an economical and developmental demand. The paper deals with the conservation concept and processes. It presents the impotence of its current programs and goals which applied by the government. It discusses the impact of conservation programs on the economic and the sustainable development of the Egyptian society. The paper suggests recommendations deals with the Egyptian contexts.

1. INTRODUCTION

Egypt has a wide range of sites in age from prehistoric sites to modern historical buildings. Nearly half of the world's antiquities are in Egypt, chronicle more than 5000 years of human history. It has about 10,000 antiquities sites; they include monumental temples, great pyramids, magnificence palaces and villas, and outstanding churches and mosques. Due to the increase of population, climatic changes, industrial activities, modern lifestyles and urban growth with squatter housing, the rise of ground-water level and pollution; the conditions of this sites was becoming progressively worse, therefore, damage and deterioration are often a result.

These valuable sites and buildings gain their values from the context and from the sittings they exist in. In most cases these buildings are integrated with different complexities into the surrounding communities.

People's lack of awareness of heritage is the most important and influential factor in ignoring conservation of that heritage. This reflects on the social, education and economic status of the population. Human development, special socio-economic and environmental improvements are important aspects in conserving our heritage.

2. THE HISTORICAL SITES IN EGYPT

Egypt is a country of unique historical richness within a special environmental setting. It has a variety of monuments and sites of culture heritage. Due to the rapid urban growth experienced in most Egyptian cities during the 1970s and early 1980s, little attention was given to the conservation of urban heritage. There are two types of conservation sites, one, is the natural sites for instance protective areas such as "Rass Mohamed, El rayan Valley, Sewa Oasis. The second type is man made sites, which is divided in to two subdivisions, first called Archaeological

sites like the pyramids, temples of Luxor... the second called traditional and historical sites which are occupied by people who live in its properties like Islamic Cairo.

The paper emphasizes on the traditional and historical sites in Cairo, Egypt, which leads to a clear understanding of the conservation and culture heritage definitions. It presents one of the biggest landscaping projects in the hart of Cairo, adjacent to an old deteriorated district called "Darb al-Ahmar". The project focuses on the social development and the training program for the local people in the community. One of its aims is to transfer the area to a valuable site and a tourism attraction.

3. CONSERVATION-CONCEPTS AND DEFINITIONS

Conservation is all the processes of looking after a site to keep and retain its culture significance. It is an umbrella term which covers a wide spectrum including maintenance, protection, preservation, reconstruction and adaptation (Taylor & Francis, 1992). It means the act or process of preserving something in being, or keeping something alive (Cantacuzino, S, 1990). Conservation means prevention against change or deterioration of a building's fabric and the maintenance of its authentic character. It is a comprehensive process that involves architects, economists, politicians and most importantly the local people.

Conservation by its general definition is a way to provide, for the existence of the greatest possible diversity, not only a better chance for the continued survival of humanity, but also for the opportunity of living in a world of richness and prosperity (Mohamed Amin, 2004). It acts to prolong the life of our cultural and natural heritage, so it is a sustainable process of continuous controlled interventions in the natural, physical and cultural environment. Sustainable conservation demands merging past and present, finding alternative uses for historic buildings or encouraging a revival of a monument's original life.

Conservation also is considered as a process of development. It involves preserving, restoring, and adapting old buildings; designing new ones that respect their contexts and the continuity of history. Collaborate the old and new together in an urban fabric of variety and richness (Ragaei M. Said, 1997). Conservation as an aspect of urban planning occurs at a variety of scales and in varied conditions. The main differences between conserving historic buildings, and other conservation aspects could be summarized in three factors; first, their scale within the urban fabric, second, their direct relation with the outer surroundings, and thirdly the complexity of use.

Conservation as a whole is the wider approach that covers complete areas through the restoration of the monuments, as well as the development of the local communities. Restoration is the most conservative form of preservation activity. It describes the process of returning the artifact to the physical condition in which it would have been at some previous stage of its morphological development.

Some conservation projects emerge with deteriorated areas within a comprehensive framework dealing with architectural and urban contexts. Different problems can be faced when it comes to urban conservation, without considering an appropriate meaning of culture heritage, and without consideration of the potential of historical areas and the needs of local communities. The aim of conservation is to promote urban life characterized by a strong sense of continuity.

3.1 Architectural conservation

It describes the process through which the material, historical, and design integrity of man kind's built heritage are prolonged through carefully planned interventions. Architectural conservation deals with issues of prolonging the life and integrity of architectural materials, such as stone, brick, glass, metal, and wood. In this sense, the term refers to the "professional use of a combination of science, art, craft, and technology as a preservation tool.

Preserving the architectural heritage is desirable for many reasons. Culturally, historical buildings remind us of our roots and add depth and character to the built environment. Preserving our historic buildings provides a unique identity for our urban structure. Older buildings trace unique styles and technical innovations, highlighting our ongoing creativity and ingenuity, as well as reminding us of our distinctive lifestyles in the past. The renovation of historic buildings and sites will increase awareness about our great assets, and encourage the utilization of some ancient architectural elements in our contemporary architecture that still need to be more responsive to our cultural heritage.

3.2 Cultural Concept Relevant to our Heritage

"Culture" generally refers to patterns of human activity and the symbolic structures that give such activities significance and importance. Different definitions of 'culture' reflect different theoretical bases for understanding, or criteria for evaluating, human activity (Forsberg, A., 2006.). It can be defined as all the behaviors, ways of life, beliefs and institutions of a population that are passed down from generation to generation. Culture has been called the way of life for an entire society. More recently, the United Nations Educational, Scientific and Cultural Organization (UNESCO, 2002) described culture as the set of distinctive spiritual, material, intellectual and emotional features of society, or a social group, in addition to

art and literature, lifestyles, ways of living together, value systems, traditions and beliefs . "Heritage" means something that someone receives. Cultural heritage can be referred to the unique cultural and physical survival of the past (Reza Abouel, 2006).

"Cultural heritage" is the legacy of physical artifacts and intangible attributes of a group or society that are inherited from past generations, maintained in the present and bestowed for the benefit of future generations. Physical or 'tangible cultural heritage' includes buildings and historic places, monuments, artifacts, etc., that are considered worthy of preservation for the future. These include objects significant to the archaeology, architecture, science or technology of a specific culture. The heritage that survives from the past is often unique and irreplaceable, which places the responsibility of preservation on the current generation.

3.3 Urban Conservation

Urban conservation is becoming an urgent issue due to the increasing tendency of city dwellers and population to move back into historical city centers. Conservation on an urban scale is concerned with the urban fabric as a whole with its contextual, and cultural outlook (Nahoum Cohen, 2002).

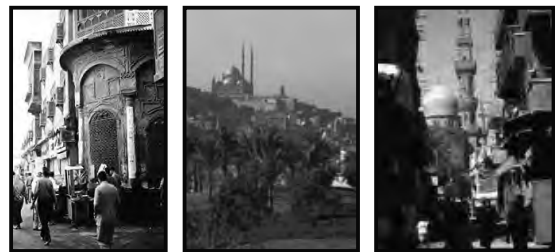

Figure 1: Cairo's historical quarter

Urban conservation is a local response to the global interest in urban heritage that opens opportunities for Local community learning. It creates a knowledge base extracted from heritage to be used in the future to mediate economic and social development. Interest in urban conservation in Cairo has been growing steadily after 1992 earthquake as national and international organizations sponsored a variety of projects in different parts of the city. Such projects suggest communal appreciation of traditional value systems and physical achievements, and provide the potential for boosting development.

The primary objective of the urban conservation program is to maximize public benefits from community while minimizing public expense in achieving these benefits. This program serves as a public awareness campaign created in order to share the city's conservation and preservation values.

Urban heritage has been highly praised for its beauty, proper utilization of local building materials, and for its respect and sensitivity to the local cultural and environmental background. Preserving urban heritage to sustain the local culture and inspire city dwellers need not stop at the physical boundaries of urbanization but rather need to extend to the urban cultural context to grasp the essence of heritage. Being a global heritage for all humanity, the old city of Cairo- Egypt inside the Ayubid walls is an example of urban heritage contexts that extend beyond the beauty and nobility of historic architecture. Urban heritage conservation should be considered a good foundation

for sound cultural planning and heritage management in our cities.

3.4 Conservation and Sustainability

Sustainability is an issue which is increasingly considered critical to the urban activities including conservation efforts. It is a characteristic of a process or state that can be maintained at a certain level indefinitely. It discusses how to make human economic systems last longer and have less impact on ecological systems.

Sustainable development is the development which leads to management of all resources in such a way that economic, social and aesthetic needs can be fulfilled while maintaining culture integrity, essential ecological processes, biological diversity and life support systems. In addition, we can describe sustainable development as a process which meets the needs of present and host communities whilst protecting and enhancing needs in the future. It is the concept of meeting the needs of the present without compromising the ability of future generations to meet their needs. The term was originally applied to natural resource situations in a long term perspective.

The term Conservation and Sustainability examines how the two key issues of urban conservation and sustainability relate to each other in the context of historic cities and how they can be brought together in a common philosophy and practice that is mutually supportive (Dennis Rodwell, 2007).

4. PROTECTING THE EGYPTIAN CULTURE HERITAGE; THE CASE OF CAIRO

The Supreme Council of Antiques SCA is the government body responsible for restoration and preservation of the culture heritage in Egypt. Until 1995, restoration projects were left to contractors under the supervision of the SCA engineers and archaeologists. The Historic Cities Support Program, formalized in 1992, undertakes specific, direct interventions focused on physical, social, and economic revitalization of historic sites in the Muslim world. It is a program of the Aga Khan Trust for Culture. It was formally established in 1988 in Geneva as a private foundation to integrate and co-ordinate the various initiatives of His Highness the Aga Khan regarding the improvement of cultural life - and in particular of the built environment, which is the most complex and tangible expression of cultural development in societies where Muslims have a significant presence. The challenge taken up by the Historic Cities Support Program (HCSP) is to demonstrate that cultural concerns and socio-economic needs can be mutually supportive. Accordingly, the program tests new strategies which combine high-tech restoration, conservation, and urban development principles with community based institution-building and fresh entrepreneurial initiatives designed to make local resources self-sustaining for the future. HCSP has undertaken restoration, urban conservation, and development projects in many Islamic Cities. The Azhar Park in Cairo is one of the major projects opened in 2004. Major parts of the adjacent, Ayyubid city wall are being restored in parallel, and a number of rehabilitation and conservation projects have been prepared in the adjacent Darb al-Ahmar district.

Cairo is certainly the most important historic city in the Islamic world, a metropolis city of about 18 million inhabitants surrounding it. Its old residential neighborhoods are suffering

from physical decline, pollution, and lack of organized community activities.

The SCA has involved in renovating Islamic and Coptic monuments, restoration of mosques in addition to Conservation and Restoration Project in Historic Cairo. Restoring Al-Muizz Street, which include five newly restored religious sites, in the heart of Islamic Cairo, to be a pedestrian zone -only falls within the framework of Historic Cairo Conservation and Restoration Projects.



Figure 2: Restoring Al-Muizz Street

5. AL AZHAR PARK -THE CONSERVATION, RESTORATION, REHABILITATION, AND REVITALIZATION PROJECT IN CAIRO

In 1997 HCSP started the conversion of a huge barren site, it is a hilly rubble-dump formed by debris accumulated over centuries. It's located between the old Fatimid city, its extension Darb Al Ahmar to the west, to the south are the Sultan Hassan Mosque and its surroundings, as well as the Ayyubid Citadel. On the eastern side is the cemetery, which became an area that developed into a dense neighborhood of its own. It's overpopulated by the needy and poor used as a place for them to reside. The Aga Khan decided to give Cairo a new park in that location which badly needed more green space. One study found that the amount of green space per inhabitant in Cairo was roughly equivalent to the size of a footprint, which is one of the lowest proportions in the world.

This large landscaping project completed in 2004, not only that it brings relief to the dense metropolitan compacted area, but it also started transforming the perception and the image of the adjacent old city. As part of the massive considerable effort on the dump slopes, many formerly buried sections of Salah el-Din's 12th century city wall, including towers, gates and interior galleries, were discovered and brought to light again. The Aga Khan extended the project to include the restoration of this part of the old wall of Cairo, which was surrounding the city in the old days.

The project also includes the development of the Area Around the old fence (Darb Al-Ahmar area) where people were living and built their houses on parts of the hidden wall, and live there. So the development process was extended to develop and enhance the people life, by giving them loans to fix their houses, improve their workshops to use them in building the facilities inside the park, also to teach children at the surrounding areas, so they can understand the area they are

living in and to be aware of their culture, and to be able to deal with the people who will visit the place.

Therefore, Al-Azhar Park provides much-needed leisure and recreational space while functioning as a “green lung” in the heart of the city. It acts as a catalyst for the physical and socio-economic revitalization of the adjacent Darb al-Ahmar district on the other side of the Historic Wall.

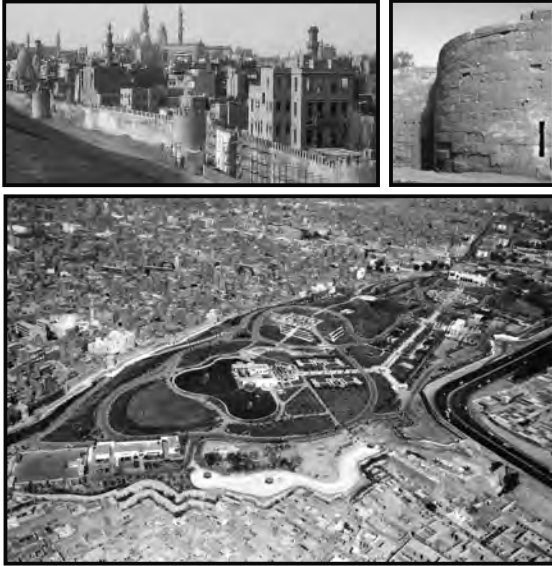

Figure 3: Al Azhar Park and the adjacent area

The design of the Park combines geometrical elements of traditional Islamic gardens with soft-shaped hills and a small lake. A network of informal pathways surrounds the more formal garden areas and leads through all levels and corners of the site. The northern edge of the Al-Azhar Park provides important connections between the Park and the commercial artery of Al-Azhar Street, close to the Khan al-Khalili bazaar.



Figure 4: Architecture Features and facilities in Al Azhar Park

5.1 Impact of the Project on the Economic and Tourism

Tourism is one of the biggest income generators and creators of millions of jobs. Jobs generated by travel and tourism are spread across the economy in many field. Travel and Tourism is acting as a catalyst for conservation and improvement of the environment and maintenance of local diversity and culture (Tourism Development Authority, 1999), The value of historical resources to a community comes from many sources; the value of the site, the value of the resource as a result of tourism, and the jobs opportunities as a result of the conservation efforts. Most cultural site have an impact on economic and tourism, this refers to the optimum tourist traffic per given time period that the site can accommodate without causing damage to the site

(Maged Iscandar,2006) . Al-Azhar Park is important for tourists to Egypt because this hilly site is surrounded by the most significant historic districts of Islamic Cairo. This site is one of the primary destinations for many visitors to the city, and this new park located in its heart provides many advantages, including a wonderful view of the surrounding area The physical characteristic of the Al-Azhar Park, the rode network, the recreation areas, landscaping, lighting and other facilities can increase the economic benefits of the site and reach the optimum absorption level of the tourism.

The tourism impact of the project benefits residents by providing employment opportunities and training of local people, it conserves resources through the concept of minimizing pollution, waste, energy consumption water usage, and landscaping

5.2 The Concept of the Project and Learned Lessons

- The project focuses on the physical, social, cultural and economic revitalization of community.
- The strategy of the project enhances public awareness of the heritage value, promote education of heritage conservation to the general public and encourage community participation. It helps the residents to re-connect with the old city through a new vision to its features.
- The primary aim of the Al-Azhar Park project is to give a boost to Darb Al-Ahmar area; its more ambitious long-term goal is to promote urban development in Cairo as a whole.
- The conservation approach has been to work with local residents to identify priorities and then take practical steps to address these needs. Community priorities, including restoration of houses, health facilities, education, solid waste disposal, job training and jobs opportunities.
- The project emphasis on the contribution between People, Authority, NGOs and the Built Environment (urban - environment - social - cultural - economic - heritage)
- An extensive social development program, including training programs, housing rehabilitation, micro-credit and health care facilities, helping residents of this community lift themselves beyond subsistence, enabling them to grow businesses and upgrade the quality of their living conditions while dealing with the project.
- The concept of the project emphasize on improving living conditions by providing job training and employment opportunities to the residents in the low-income neighborhood of Darb al-Ahmar, in different sectors such as, furniture manufacturing and tourist goods production. Also, hundreds of young men and women have found work in the park, and on project teams restoring the Ayyubid wall.
- The park constructions, as well as the historic wall conservation act as stimuli for the rehabilitation of Darb al Ahmar. Ayyubid city wall are being restored in parallel, and a number of housing rehabilitation and conservation projects have been prepared in the adjacent Darb al-Ahmar district.
- The project is a generator of economic and social community development, through its role as a culture center attracts tourists and different classes from the society.
- Applying the concept of social responsibility through allowing the resident of Darb Al- Ahmar area to use the garden with special rate offer.
- Housing rehabilitation activities undertaken by the Aga Khan Trust for Culture are expected to average 50 houses per year. A housing credit system is aiding private individuals in the rehabilitation of their own houses.

- Design of a pedestrian access and traffic along the western boundary of the park to support the perception that the historic wall is a dynamic meeting place rather than a barrier between the community and the park.

6. CONCLUSION

The study deals with the conservation concept and its influence to the cultural heritage. It presents the objectives of the Urban Conservation and its current programs and goals which applied by the government and The Historic Cities Support Programs. It discusses the impact of conservation programs on the economic, tourism and the sustainable development of the Egyptian society. It presents the Conservation and Restoration of Al-Muizz Street, to be a pedestrian zone, within the framework of The SCA in Historic Cairo. This paper focuses on a recent urban Conservation Project in the heart of Islamic Cairo "Al Azhar Park", as one of the biggest landscaping project which started transforming the perception and the image of the adjacent old city. The project is included the restoration of the old wall of Cairo, and the socio-economic revitalization of the adjacent Darb al-Ahmar district on the other side of the Historic Wall. The project focuses on the social development and the training program for the community. The research ends with lessons learned from the discussion of conservation, architectural heritage and the concept of using such projects as a knowledge base and a generator of economic and social community development.

7. RECOMMENDATIONS

- Taking into consideration the needs of the local people as a priority in urban conservation projects.
- The important role of the social programs which lead the individuals to feel and interact with the place.
- The project would not have been successful without effective partnerships with a number of international, national and local NGOs and institutions of the Social Development Fund.
- The Conservation Projects must be undertaken from an approach based on the urban heritage cultural.
- The conservation policy should set guidelines for future development resulting from changing needs.
- Conservation is a part of the universal aspiration; it is a cultural activity which needs to be evaluated in the perspective of a cultural tradition; a society expressing itself as a nation or a community; and a universal concern for aesthetic messages delivered by parts of the world's patrimony.
- Creative solutions to be catalysts for social and economic development and the overall improvement of the quality of life in the district.
- Public-private partnerships can be effective mechanisms for enhancing the value of underused, unappreciated or even unknown social, cultural and economic assets.
- The conservation of historic cites should be an essential part of a coherent policy of economic, social development, tourism and urban planning.
- Site and Tourism should be managed in a sustainable way for present and future generations. Tourism and conservation activities should benefit the local community.

8. REFERENCES

References from Books:

Dennis Rodwell, 2007, Conservation and Sustainability in Historic Cities, USA.

Forsberg, A, 2006, Cultural Geography course notes, Definitions of Culture CCSF, Retrieved.

Nahoum Cohen, 2002, Urban Planning Conservation and Preservation, McGraw Hill, New York

Tourism Development Authority, 1999, Guidelines for Eco-lodge Development in Egypt, Cairo, Egypt.

World Travel & Tourism Council and International Hotels & Restaurant Association, April 1999, The Global Importance of Tourism, Department of Economics & Social Affairs, New York.

References from Conferences:

Cantacuzino, S., 1990, Conservation in a local context, Architecture and Urban Conservation in the Islamic World, Geneva.

Maged Fahim Iscandar, 2006, A Future for Old Cairo, Appropriating Architecture Taming Urbanism in the Decades of Transformation, Cairo University - Faculty of Engineering, 3rd Conference, Egypt.

Mohamed A. M., 2004, Conservation between Theory and Practice, 2nd. International Conference, Cairo University, Faculty of Engineering, Department of Architecture, Egypt.

Ragaei M. Said, 1997, Sustainable Urban Conservation-Principle and Basic Issues, International Conference – Culture Heritage and Architectural Education, MIU, Cairo, Egypt.

Reza Abouel, 2006, the Appropriate Conservation of Historic Areas: Moderation in Conservation, 3rd. International Conference, Cairo University, Faculty of Engineering, Department of Architecture, Cairo, Egypt.

References from Journals:

Taylor & Francis, 1992, International Journal of Architectural Heritage Conservation, Analysis, and Restoration, Volume no. 2, Print ISSN: 1558-3058 Online ISSN: 1558-3066

UNESCO, 2002, Universal Declaration on Cultural Diversity, issued on International Mother Language Day.

References from Websites:

http://en.wikipedia.org/wiki/Architectural_Conservation
<http://weekly.ahram.org.eg/2007/857/eg11.htm>

TEXT RECOGNITION IN BOTH ANCIENT AND CARTOGRAPHIC DOCUMENTS

N. Zaghden ^{a,b}, B.Khelifi ^{a,b}, A.M Alimi ^a, R.Mullot ^b

^a REGIM: Research Group on Intelligent Machines, University of Sfax, ENIS, Department of Electrical Engineering, BP W - 3038, Rte Soukra km3.5, Sfax, Tunisia – (nizar.zaghden, khelifi_badreddine, adel.alimi)@ieec.org;

^b L3i: Laboratoire Informatique Image Interaction, university of La Rochelle, Sciences Faculty, Av. Michel Crépeau La Rochelle Cedex 17042 France - remy.mullot@univ-lr.fr

KEY WORDS: text matching, ancient documents, Cartographic maps, wordspotting, recognition, global and local features.

ABSTRACT:

This paper deals with the recognition and matching of text in both cartographic maps and ancient documents. The purpose of this work is to find similar text regions based on statistical and global features. A phase of normalization is done first, in object to well categorize the same quantity of information. A phase of wordspotting is done next by combining local and global features. We make different experiments by combining the different techniques of extracting features in order to obtain better results in recognition phase. We applied fontspotting on both ancient documents and cartographic ones. We also applied the wordspotting in which we adopted a new technique which tries to compare the images of character and not the entire images words. We present the precision and recall values obtained with three methods for the new method of wordspotting applied on characters only.

1. WORD FEATURES EXTRACTION

1.1 Methodology

To characterize the textual contents of the images of ancient documents, we opted for describing the words or even the characters and not to work with a whole page of document. This is due to the fact of the nature of our application. In fact the images of documents which we have (Tunisian national library, base of madonne, British library) which have different properties from contemporary documents images. In more, the images than on whom we work did not contain the same noise and the words are also not normalized. Of this, the idea to work with imagerettes words was born. In object to characterize textual content of our heterogeneous basis, we opted for beginning with the characterization of small entities in documents (characters, pseudowords...).

As first application, we chose to characterize blocks texts belonging to the same image after having cleaned the image by a gaussian filter. We followed the steps presented in the diagram presented in the figure 1.

1.2 Font Recognition

The optical font recognition known as OFR, is interested in the recognition) of the font of a writing. The optical recognition of characters is a domain which was already the object of multiple researches; however the main OCR systems (Optical Character Recognition) were applied to monofont texts. We were able to realize during our previous works so impressive results with wavelets and fractals for the characterization of printed Arabic fonts [Zaghden 2006] and we were even able to show the robustness of the new method that we adopted (CDB) to calculate the fractal dimensions of the images. This method allowed us to show its robustness in front of white gaussian noise especially if we compare it with the wavelets, which showed a net decrease in the rate of recognition of fonts.

We obtained in fact recognition rates lower than 30 % with wavelets on these degraded images.

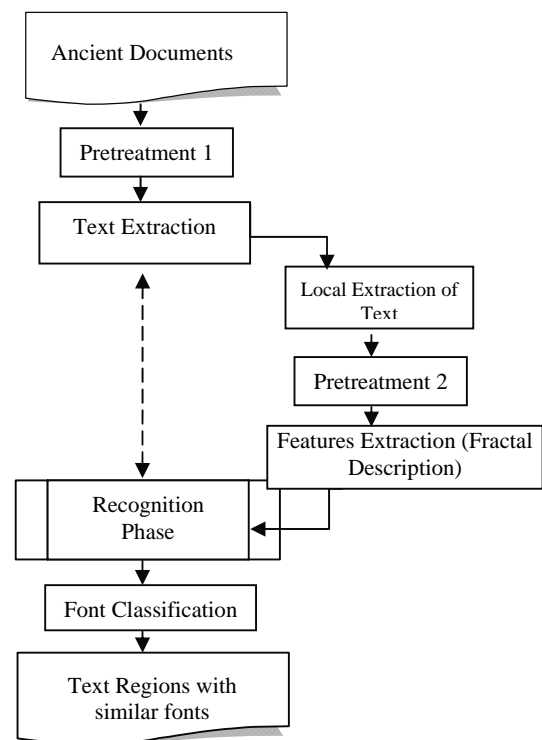

Figure 1: Organigram of the recognition font approach

In terms of recognition, we noticed a net performance of the new method which we adopted for the calculation of the fractal dimension (CDB). Indeed this method, allowed us to reach a recognition rate of 96.5 %. The obtained results prove that the methods which we adopted for the recognition of multifont texts can be applied to develop a strong character recognition system. Indeed the methods which we developed can be applied to a wider number of fonts and we prove in this paper that with this technique we can characterize different styles of texts contained in the same document.

The new method which we developed for the calculation of the fractal dimension (CDB) is inspired by the method of counting by Box [Zaghden 2006]. Among other by-products of this method, there is a method of counting of reticular cells [Gangepain 1986] and also the method of Differential Box Counting [Sarkar 1992, Sarkar 1994, Cho 99].

1.3 Characterization of textual documents by fractal dimensions

The robustness of the fractal dimensions was also illustrated in the characterization of different text styles of ancient documents where we notice the presence of three essential fonts (figure 3). We also demonstrated the possibility of this method to make the differentiation of scripts and fonts in the same image as it is shown in a cartographic map (figure2).

Certainly before making the characterization of the writing contained in the images we made first of all stages of pretreatment based on the works of [Khelifi 2007]:

1. Separation and reduction of colours
2. Elimination of the isolated pixels
3. Extraction of connected components
4. Segmentation of the textual constituents of the image



Figure 2: Extracted classes from cartographic image

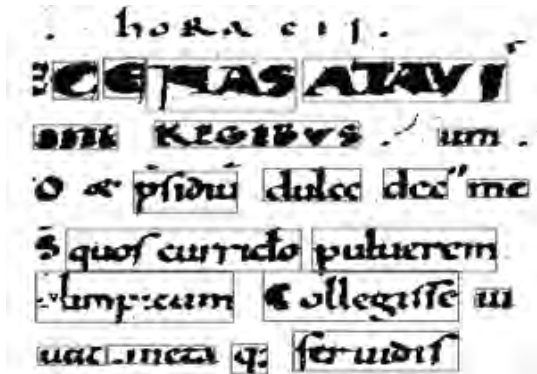

Figure 3: Extracted classes from ancient document image

The inconvenience of this method is that we treat only the horizontal texts and we are now developing a system allowing us to correct the slope of texts to categorize in an effective way the various types of text which we can find in the various categories of ancient documents. This classification is of a big importance during categorization of the classes in several images.

2. TEXT MATCHING

2.1 Local Descriptors

After having applied global descriptors such as fractals to describe textual content of images, we chose to apply the matching of text images after having described them by local descriptors such as projection profiles, Euclidian Distance Map, XOR...

We can characterize various blocks text of the same size with the function XOR, in which we represent in the image result a white pixel only if it is a white pixel in one of the first two images and it is the opposite in the other image. So the function XOR works pixel by pixel. The calculation of the similarity between two images is done by applying this function between the new shape and the model in the basis. In the figure 18 we present the result of the function XOR on two occurrences of the same line.

So we can conclude that the function XOR can resolve the problem of recognition of the images words of ancient documents. Indeed we applied the Euclidian distance map algorithm to calculate the error between the images. Indeed every white pixel in the resultant image XOR error, so the function EDM applied to XOR allows us to obtain a vector measuring the error between two images.

This can simplify us the task especially if we choose to limit our application and to make a user interface in which, the user annotate for example words similar to the images words of our basis.

mayor, tanto te humilha e

(a)

mayor, tanto te humilha e

(b)

mayor, tanto te humilha e

(c)

Figure 4: Application of XOR to two occurrences of the same line

2.2 Proposed Approach

The method that we just discussed allows us to make the wordspotting of the words images of ancient documents. The only problem is related in fact with the basis of images which we possess. George Washington's manuscripts possess several redundant words and many researchers worked on it [Manmatha 1996, Rath 2003], only the problem it is that we were not able to reach all the manuscripts. We chose to make the wordspotting on the images of the national library, Madonne and the base of Gutenberg and this is due to the fact that the words in our base are not too redundant. So to be able to give a significant result with many images in the base of test and learning, the samples which we treat, will be many. The

method which we chose is not to work with a whole word but rather to work with the images of characters.

The documents on which we make our approach are only the ancient printed documents and essentially issued from the base of Madonne. Indeed, we make a first segmentation of the images based on the method developed in [Khelifi 2007] allowing to group the blocks of the images texts. Then we treat every block by choosing as criterion of separation between the characters to be segmented, the presence of white pixels. Certainly this approach allows to make the correspondence between characters on ancient printed documents but she will also allow to characterize pseudowords (Blobs) issued from the ancient handwritten documents in particular the Arabic characters printed or manuscripts owed to the fact of the nature of the Arabic writing, which is cursive by nature.

First of all we chose to work with the function XOR followed by the algorithm EDM to calculate the errors between the images requests and the images of the basis (figure 5); the images (c) and (d) present respectively the result and the complement to the result of the function XOR applied to the images (a) and (b).

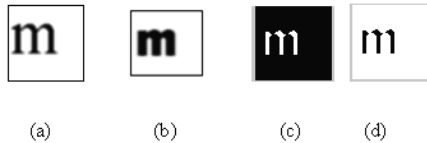

Figure 5: Application of XOR function to two occurrences of character "m"

Secondly we calculated the projection of profile of the images of characters.



Figure 6: Vertical Profile of character "m"

The result of every character is compared in fact with the other characters of the document. So the advantage of our approach consists in the fact that we work with a not supervised classification, which applied in our domain of application will have certainly many advantages that the methods based on supervised classification.

One of the main advantages is that we do not know the number of classes or characters in advance whether it is in one image of ancient document or in all the basis. We became aware of this problem when we made Self Organizing Map's algorithms and K_means and we showed that the number of class can never be fixed from a document to the other especially if we work with images of heterogeneous documents belonging to various centuries and certainly having various characteristics.

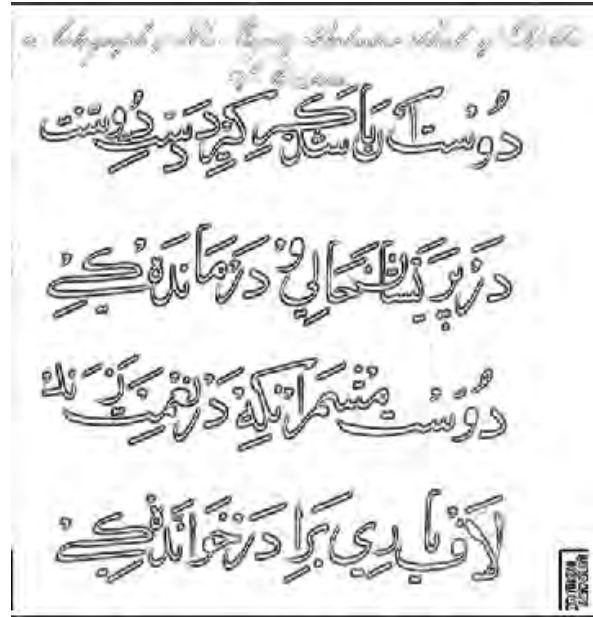

Figure 7: Application of The Self Organizing Map on an ancient document image

The images to which we applied our algorithms are the ones issued from the basis of madonne and of Gutenberg because the base of the national library contains much more noises and that the techniques that we developed are not rather effective on such degraded images. The images that we treat here contain the noise due to the weak resolution and also to the artefact resulting from the compression of collected images.

A phase of pretreatment is applied to the images (gaussian filter followed by the elimination of the isolated pixels) in the first place.

Our experiments touched only the images of Latin characters the number of which is 7280. Then we tested images of words of documents printed the number of which amounts to 100. These images tests repeat 135 times in the images considered in our base of learning (There are words which repeat more than only once).

We so calculated the terms precision and recall for two various methods which we adopted:

- XOR
- EDM (having applied XOR)
- Vertical Projection followed by the algorithm EDM

We present in the table below the results obtained with three described methods.

Method	XOR	EDM	Vertical Projection
Precision	63.14%	78.43%	41.67%
Recall	55.34%	79.32%	34.46%

Table 8: precision and recall rate of adopted methods

We can notice also that the best rates of recognition were obtained with the EDM method. Certainly this rate is the best in comparison with the methods which we tested but it will certainly be improved by adding the other criteria.

Among the works that we are making now, there is a correction and the improvement of the slope of the characters issued from ancient documents as well as the normalization and the centring of the characters. Other techniques also make our current domain of study such as the DTW (Dynamic Time Wrapping) function used for a long time in the analysis of the signals.

3. CONCLUSION

We tried in this paper to characterize the textual contents of the images of ancient documents. We tried several algorithms treating the pages of documents altogether such as the K-means algorithm and the algorithm "self organizing map", in order to categorize the various classes contained in our documents. We concluded that such methods cannot be taken as standard methods and effective capable of categorizing the textual entities of our documents. We also tried to apply global approaches for the measure of texture such as the fractal dimensions from the method CDB. We were able to categorize the various types of writings of our images. We also applied the wordspotting in which we adopted a new technique which tries to compare the images of character and not the word images or pseudowords. Some improvements are in the course of study to improve the rate of precision and recall.

4. REFERENCES

- Cho, J.H., Park, C.W., Cha, E.Y., 1999. Learning data composition and recognition using fractal parameters. International Joint Conference on Neural Networks (IJCNN), vol 4, pp 2872-2875.
- Gangepain, J., Carmes, C. R., 1986. Fractal approach to two dimensional and three dimensional surface roughness. wear 109, pp 119-126.
- Khelifi, B., Elleuch, N., Kanoun, S., Alimi, M. A., 2007. Enhanced Color Based Method for Text Extraction from Maps. International conference MM-CCA, Jordan.
- Manmatha, R., Han, C., Riseman, E., 1996. Word Spotting: A New Approach to Indexing Handwriting. In: Proc. of the IEEE Computer Vision and Pattern Recognition Conference, San Francisco, CA, longer version available as UMass Technical Report TR95-105.
- Rath, T. M., Manmatha, R., 2003. Word Image Matching Using Dynamic Time Warping. In: Proc. of the Conf. on Computer Vision and Pattern Recognition (CVPR), Madison, WI, vol. 2, pp. 521-527.
- Sarkar, N., Chaudhuri, B.B., 1992. *An efficient approach to estimate fractal dimension of textural images*. Pattern Recognition, vol 25, N° 9, pp 1035-1041.
- Sarkar, N., Chaudhuri, B.B., 1994. *An efficient differential box-counting approach to compute fractal dimension of image*. IEEE Trans.Systems, man, and cybernetics, vol 24, N° 1, pp 115- 120.
- Zaghden, N., Ben Moussa, S., Alimi, M.A., 2006. Reconnaissance des fontes arabes par l'utilisation des dimensions fractales et des ondelettes, Colloque International Francophone sur l'Ecrit et le Document (CIFED 06), Fribourg(Suisse), pp-277_282.
- Zaghden, N., Ben Moussa, S., Alimi, M.A., 2006. Reconnaissance des fontes arabes par l'utilisation des dimensions fractales et des ondelettes, Colloque International Francophone sur l'Ecrit et le Document (CIFED 06), Fribourg(Suisse), pp-277_282.

COMPLEXITY, AMBIGUITY AND UNCERTAINTY: A USER-CENTRED APPROACH TO MAXIMISING ACCESS AND USE OF EVENT-BASED CULTURAL HERITAGE DATA.

Professor Stephen Brown.

Knowledge Media Design, De Montfort University, Leicester LE1 9BH, UK - sbrown@dmu.ac.uk

KEY WORDS: user-centred design, usability, exhibition, catalogue, photography, event-based data, prototyping

ABSTRACT:

Current EU (FP7) funded research priorities in the cultural heritage domain understandably favour projects that address generic and large scale systemic issues such as barriers to mass digitisation, automated content capture and data mining, resource sharing, multilingual access and broad frameworks for long term data preservation. While these are undeniably important, access to and use of cultural and scientific resources also depend on the usability of individual Web sites. The majority of Web sites are difficult to use, resulting in frustration, unnecessary costs and loss of repeat visits. Users do not wish to invest significant time in learning how to get the best out of a site. So interface design is a significant factor in determining levels of access and use. This paper examines some interface design challenges encountered in the context of developing an online database of historical exhibition catalogues. It identifies issues that distinguish event-based data sets from other database design projects and discusses the extent to which a user-centred design approach and paper prototyping in particular can help to address these issues.

1. INTRODUCTION

“EU-funded research on digital culture and digital libraries deals with leading-edge information and communication technologies for expanding access to and use of Europe’s rich cultural and scientific resources. It also investigates how digital content created today will survive as the cultural and scientific knowledge of the future (digital preservation).” (DigiCult, 2007)

Current EU (FP7) funded research priorities in the cultural heritage domain are focussed on access to, use of and preservation of cultural and scientific knowledge. Understandably this tends to result in projects that address generic and large scale systemic issues such as barriers to mass digitisation, automated content capture and data mining, resource sharing, multilingual access, and broad frameworks for long term data preservation. While these are undeniably important priorities, access to and use of cultural and scientific resources depend also on micro factors associated with the design quality of individual Web sites. Sites which have a clear purpose, are easy to navigate and search and which provide tools that help users to achieve their goals efficiently are more likely to encourage and facilitate access and use than poorly designed sites.

While this is not a new insight, it is still important and requires action because the usability of Web sites is generally poor. According to User Interface Engineering, (2001) people cannot find the information they seek on Web-sites about 60% of the time. This can result in loss of repeat visits. Badly designed sites lose repeat visits from 40% of the users (Manning et al., 1998). It can also result in wasted time, reduced productivity, increased frustration, and revenue, increased training and increased support costs. Trained researchers might be expected to have more sophisticated digital resource search strategies, but recent research (Brown et al 2006) showed that Arts and Humanities researchers tend to employ relatively unsophisticated strategies (single or two word phrase searches in popular search engines are common.) and generally they are largely unaware of the possibilities for data analysis and

multimedia data presentation that digitisation offers.. Moreover, they are reluctant to invest significant amounts of time to better understand and use resources (Warwick et al, 2006). Arguably therefore, micro Web design factors are as important for long term adoption and use as more generic and systemic research topics. This paper examines some interface design challenges encountered in the context of developing an online database of historical photographic exhibition catalogues. It identifies issues that distinguish event-based data sets from other database design projects and discusses the extent to which a user-centred design approach and paper prototyping in particular can help to address these issues.

2. THE RESOURCE

Study of the early history of photographic practice is hampered by the limited availability of primary resources. Early artefacts were often unique (e.g. Daguerrotypes) and made from ephemeral materials, so survival was precarious. In England, for example, the studio records of Jean Antoine Claudet (1797-1867) and his collection of early photographic incunabula were all destroyed by fire. While many major figures are well documented thanks to their prominence at the time (e.g. Hill and Adamson) and the survival of archives, (e.g. The correspondence of William Henry Fox Talbot in the UK and the studio records of Southworth and Hawes in the USA), much less is known about the history and contributions of large numbers of other figures.

A useful source of data is surviving exhibition catalogues. Although various photographic societies flourished in 19th century Britain and held their own annual exhibitions, catalogues from most of these societies have not survived in any significant numbers. In contrast, the surviving catalogues from what is now the Royal Photographic Society’s annual exhibitions, from 1870 onwards, contain detailed entries on photographers, photographs and commercial companies, including, from 1895 accompanying line or half tone illustrations of some of the photographs exhibited. Collectively, these exhibition records offer a unique insight into the evolution

of aesthetic trends, the application of photographic processes and the response of a burgeoning group of photographic manufacturers, as well as the fortunes of the Photographic Society itself. The society's exhibitions attracted a wide constituency of photographers, from Britain, Europe and America. Many individuals launched their photographic career by exhibiting at the Royal Photographic Society and a significant number went on to become leading practitioners of their day. The exhibition catalogues were published in full in the journal of the Society: *The Photographic Journal*, copies of which are available in many research and public libraries. However, even major UK libraries such as the National Science Museum and the British Library do not hold complete runs and loan policies are restrictive, making it difficult for most researchers to access and compare data such as exhibition sections, processes and exhibitors across different years.

Our intention therefore was to provide online access to and facilitate the use of these catalogues by researchers, primarily those working in the field of photographic history, but also with a view to wider research audiences concerned with technological and scientific developments, art, culture and social trends. Our objectives were to build an information resource that combined browsable rich visual information (page scans and photographic exhibits) with highly structured searchable data (exhibition catalogue entries). The focus of our work was from 1870 when the first catalogue was published, to 1915, after which the annual exhibitions became smaller in scale and national in character as the First World War began to affect the progress of photographic culture throughout Britain and Europe.

The catalogues themselves contain three broad categories of information: details of the exhibitions (dates, venue, title, sections, judges); the exhibits (exhibit number, title, exhibitor name, photographic process, award status, price and sources; and exhibitors (name, title, address, RPS membership, qualifications and affiliations). However, the exhibitions were discrete annual events. While there was some continuity from year to year, inevitably over the 45 year period in question there were changes in exhibition content, structure and presentation, which are reflected in the catalogues. As time went by, the exhibitions became more complicated, trade entered the picture, the photographic press and industry became more complex, there were more products to choose from, more participants and ideas and technologies changed. The catalogues themselves also evolved. Thus in 1876 the first adverts appeared in the catalogue, in 1880 for the first time the judges were listed and by 1895 pictures began to appear to illustrate the exhibits. In 1870 the catalogue ran to 8 pages only, but this rose to over 100 pages in the early 1900s. These variations created significant challenges for the design of the user interface generally and in particular for the design of the search interface. A few examples illustrate the range of problems encountered.

2.1 Changes to the exhibition structure

Different, named, sections within the exhibition were only introduced for the first time in 1877 and their number and their names changed frequently thereafter. In the three years from 1905 to 1907 the number of sections in the exhibition stabilised more or less, yet as the following extracts show, the names and subject matter of the sections evolved quite noticeably even in this short space of time.

In 1905 there were seven identifiable sections:

Lantern Lectures / Pictorial / Scientific and Technical Photography and its Application to Processes of Reproduction / Lantern Slides in the Scientific and Technical Section / Loan Collection of British Technical and Scientific Photographs from the St. Louis International Exhibition of 1904 / General Professional.

By 1906 these had evolved into eight sections with broadly similar titles:

Lantern Lectures / Pictorial / Scientific and Technical Photography and its Application to Processes of Reproduction / Scientific and Technical Photography and its Application to Processes of Reproduction. By Invitation from the Council / Lantern Slides in the Scientific and Technical Section / Transparencies in the Scientific and Technical Section. By Invitation from the Council / General Professional Photographs / Photographic Apparatus and Material.

In 1907 there were again eight sections but with slightly different titles: Lantern Lectures / Pictorial / Scientific and Technical Photography and its Application to Processes of Reproduction / Scientific and Technical Photography and its Application to Process of Reproduction / Scientific and Technical Photographs, &c. / The Autochrome. Collected and Arranged by R. Child Bayley and Thos. K. Grant, By Invitation from the Council / General Professional Photographs / Photographic Apparatus and Material.

The way in which an exhibit might be classified thus varies considerably over the entire 46 year period. A "transparency" might at different times have been exhibited under any of the following section headings:

- Autochromes
- Autochromes and Other Colour Transparencies
- II. Colour Photography. Autochromes and Other Colour Transparencies
- II. Colour Transparencies
- III. Colour Photography, Including Autochromes and Other Direct Screen-Colour Transparencies
- II. General Photography, including Lantern Slides and Stereographs, Lantern Lectures
- II. Scientific, Natural History, Colour, and General Photographs - Lantern Slides
- II. Scientific, Natural History, Colour, and General Photographs - Stereoscopic Slides
- II. Scientific, Natural History, Colour, and General Photographs -Transparencies
- Lantern Slides in the Scientific and Technical Section
- Stereographs and Transparencies in Sections II, III. and V
- Stereoscopic Photographs
- Lantern Slides
- Lantern Slides and Transparencies
- Stereoscopic and Lantern Transparencies
- Stereoscopic and Lantern Transparencies and Prints
- Stereoscopic Slides, Stereoscopic Transparencies
- Transparencies
- Transparencies in Sections II. and III. - Colour and Monochrome
- Transparencies in Sections II. and III. - Stereographic Transparencies
- Transparencies in the Scientific and Technical Section. By Invitation from the Council
- III. Scientific and Technical Exhibits, Natural History, Colour Prints, Lantern and Stereoscopic Slides

In order to be as faithful as possible to the original data in the catalogues it is necessary to list all these different sections individually, even in the drop down search menus. Yet this could make the menus impossibly long and confusing for most users. On the other hand, it seems likely that researchers interested in one type of transparency such as Autochromes, may be interested in some other types, such as Colour Transparencies and even possibly Lantern Slides. So some grouping of categories might be more useful for researchers because it would reduce the length and complexity of the searches required to identify all the items relevant to a query concerning transparencies. There is thus a tension between the need for accuracy on the one hand and usability on the other, created by the complexity of the data.

2.2 Variations in exhibit descriptions

An exhibit entry could potentially include up to 14 different items of information, as shown in figure 1. However not all fields are required for every exhibit. Prior to 1877 the exhibition was not divided into different sections, not all exhibits had multiple exhibitors, or sub components, or were part of a larger group. Furthermore different kinds of exhibits were catalogued in different ways. For example “Lantern Lectures” and “Stall holders” were not given exhibit numbers and fields such as “process” and “prices” did not apply to the latter.

Details of exhibit	
<i>Exhibition Year and Title:</i>	1915 Sixtieth Annual Exhibition of the Royal Photographic Society of Great Britain
<i>Exhibitor:</i>	G. Suter
<i>Exhibitor 2:</i>	
<i>Section:</i>	Pictorial Photography
<i>Group Title:</i>	
<i>Exhibit No.:</i>	6
<i>Exhibit No. 2:</i>	
<i>Exhibit title:</i>	A Glimpse of the Weisshorn Summit
<i>Description:</i>	
<i>Sub-exhibits:</i>	
<i>Exhibit type:</i>	Photograph
<i>Process:</i>	Bromide
<i>Award:</i>	none
<i>Prices:</i>	Original Framed 12/6
<i>Source(s):</i>	

Figure 1: A specimen exhibit record

The usability issue here is again related to complexity and variation in the data. To show all fields for every exhibit would result in long tables of largely empty cells, making them difficult to read and tedious to page through. Omission of empty cells on the other hand hides from the user the hint that searches for other kinds of data are possible.

2.3 Exhibitor name variations

Table 1 shows a listing of exhibitor records for the surname “Abney”. From this list it is clear to a human observer that “Abney, C.E.” is not the same person as “Abney W. de W.” but that the various W. de W. Abneys and Captain Abney (1875 and 1889) are the same person. So should a search for “Capt. Abney” return results for “Captain Abney”, “Lieut. Abney” and “Sir W. de W. Abney” as well? Or all entries for “Abney” just to be on the safe side?

Records for Abney			
Year	Name	Title	Address
1905	Abney, W. de W.	Sir	Rathmore Lodge, Balfour Gardens, South, S.W.
1906	Abney, W. de W.	Sir	[Not Listed]
1870	Abney, W. de W.	Lieut.	Chatham
1871	Abney, W. de W.	Lieut.	Chatham
1872	Abney, W. de W.	Lieut.	Chatham
1873	Abney, W. de W.	Captain	St. Margaret's, Rochester
1875	Abney,	Capt.	St. Margaret's, Rochester
1876	Abney, W. de W.	Capt.	Rochester
1878	Abney, W. de W.	Captain	3, St. Alban's Road, Kensington
1879	Abney,	Captain	3, St. Alban's Road, Kensington
1879	Abney, C. E.		[Not Listed]
1880	Abney, C. E.		Derby
1881	Abney,	Captain	3, St. Alban's Road, Kensington
1881	Abney, Charles E.		Derby
1882	Abney, W. de W.	Captain	3, St. Alban's Road, Kensington, W.
1883	Abney, W. de W.	Captain	Willeslie House, Wetherby Road, South Kensington
1883	Abney, C. E.		St. James Street, Derby
1884	Abney, C. E.		6, St. James's Street, Derby
1884	Abney,	Captain	Willeslie House, Wetherby Road, South Kensington, S.W.
1887	Abney, W. de W.	Captain	[Not Listed]
1888	Abney, W. de W.	Captain	Willeslie House, Wetherby Place, South Kensington, S.W.
1889	Abney,	Captain	Willeslie House, Wetherby Road, S.W.
1889	Abney,	Capt.	[Not Listed]
1893	Abney, W. de W.	Capt.	Willeslie House, Wetherby Place, South Kensington, S.W.

Table 1: Entries for exhibitor “Abney”

While it is easy enough to associate variations on a name in the database so that a search for that name returns all the associated hits, the difficulty lies in deciding which names to associate with each other. While it is highly probable that Captain Abney (1892) is the same person as the other W. de W. Abneys, this cannot be deduced conclusively from the evidence in the table. In other cases, for example where a woman changed her name and address on marriage, the degree of interpretation required is even greater.

The problem here is how to deal with ambiguity and uncertainty. This is not so much a problem while one is searching for a particular name. The researcher can make their own judgment about which of the various records apply to the same person. But it does become problematic if one wishes to consult a comprehensive record of activity for a particular individual. Because we are dealing here with a database, it is possible to perform actions that would be tedious and time consuming if they had to be done manually, working from the original catalogues. For instance, it is a very simple matter to list all the records for a particular exhibitor in a single table so that their complete pattern of activity across the years can be seen.

The difficulty lies, as we have seen, in knowing for sure that exhibitors with similar names in different years are indeed the same person. Again there is a tension between increased usability (grouping all the Abneys together so that the record for Abney shows their full history) and data reliability and accuracy (showing each entry for Abney separately so that the research researcher has to choose which entries to collect together to build up the history for themselves).

2.4 Errors

Not surprisingly the original catalogue entries contain errors as well as variations in the data. For example, exhibitor “Marjory T Hardcastle” appears with alternative spellings of “Marjory” and “Margery”. While a search for “Hardcastle” would return both variations, an exact word search for one of them would not include the other. It would make searching for specific items

easier if obvious errors like this were corrected. However errors are not always so easy to spot and there may be differences of opinion as to which is the correct version. So error correction raises the possibility of introducing more substantive errors of fact. This is another, different, example of uncertainty and poses the same dilemma as the name variation example above. How far should one interpret the data in order to improve usability?

While there were many more issues, these few serve to illustrate the themes of complexity, variation, ambiguity and uncertainty that emerged and which seem to belong in particular to event based data series such as historical catalogues where there is lack of continuity and only weak ties between the individual data sets.

3. METHODOLOGY

While the database tables were determined to a large extent by the catalogue data itself, the data views and the interface design issues were tackled using a user-centred design approach. User-centred design (Katz-Haas, 1998; Vergo et al, 2001) offers a methodology for ensuring designs are effective by closely matching them to user expectations and needs, based on user requirements analysis and testing. This approach makes the user rather than the product the focus of attention and it employs an iterative process of design and evaluation from the very start of the project (Henry and Martinson, 2003) as shown in figure 2.

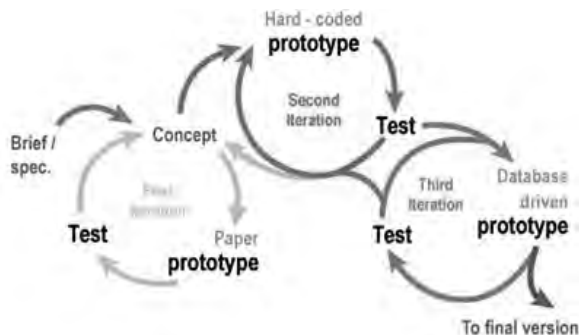

Figure 2: Iterative design and test cycles

The emphasis in each test is on “usability”. The International Organisation of Standardisation (ISO) (ISO 9241-11, 1994) identifies three key factors associated with the usability of an interface: effectiveness, or the extent to which the intended goals of use of the overall system are achieved; efficiency, or the effort required to achieve the intended goals; and satisfaction, or the extent to which the user finds the overall system acceptable (John and Marks, 1997). Nielsen (1993) offers a more nuanced list as follows:

1. Learnability: ease of learning to use the system so that the user can get started rapidly.
2. Efficiency: once the system has been learned, a high level of productivity should be possible.
3. Memorability: casual users should be able to return to the system after some period of not having used it without having to relearn everything.
4. Errors: it should be easy to recover from errors. Also catastrophic errors should never occur.
5. Satisfaction: the system should be satisfying to use.

As noted above, usability is important because people cannot find the information they seek on Web-sites about 60% of the time (User Interface Engineering, 2001), badly designed sites lose repeat visits from 40% of the users (Manning et al., 1998) and even trained researchers have difficulties finding the resources they are looking for (Brown et al 2006).

Since evaluation trials in user-centred design are undertaken right from the start, they necessarily involve testing of prototypes. Prototypes vary according to the stage of the process and the purpose of the trial. Usually the choice is between three types (Nielsen, 1993): “vertical” which offer in-depth functionality for a few selected features, “horizontal” which offer full interface features but no underlying functionality, and “scenario” which offer functionality for specific pathways or task scenarios. In this project we began with paper based “horizontal” prototypes to test the overall concept followed by paper based scenarios in the second round.

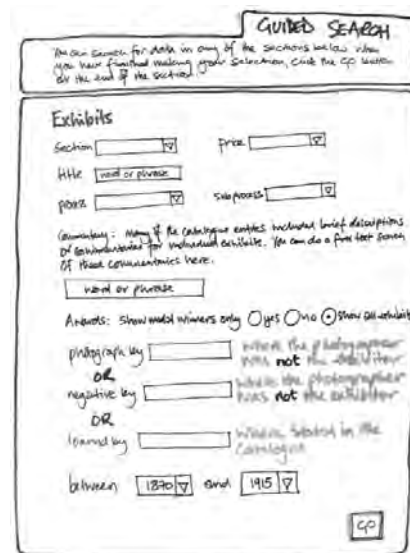

Figure 3: A paper prototype advanced search page for exhibits

In the third round, screen based “scenario” types with dummy data were used and in the final round subjects used a fully functioning screen based system connected to a prototype database. Paper based mock-ups were used in the earlier stages because they are quick and cheap to produce, can be modified easily and make users feel more relaxed about offering criticisms (Rettig, 1994). Figure 3 shows a typical hand drawn mock-up for an advanced search page.

The first iteration entailed showing users simple hand drawn pages to find out how easy it was for them to understand what the site was about, what it did and how to find certain types of information on the site. Subsequent trials were more objective, requiring users to locate specific information in response to a series of questions. A sample set of scenario questions is as follows:

1. You are researching Alvin Langdon Coburn and want to use the ERPS site to find any references to his work and his involvement with the RPS.
2. You now want to start a new search looking for all individuals who were associated with both the Royal Society and the RPS between 1870 and 1900.

3. From these results you now want to find anyone who took photographs in South Hertfordshire at the turn of the century, so need to find exhibitors based in Watford between 1890 and 1900.
4. You are interested in scientific photography in the 20th century and want to find exhibits of scientific interest which were awarded medals.
5. You are researching your family history and know that one of your relatives was an early photographer, so you want to find an exhibitor from the 1873 exhibition called Dogberry, who you think was not a member of the RPS.
6. You are interested in your local area history and specifically the development of specialist businesses that employed local people in the late 1800s. Therefore want to find all exhibits to do with Westminster between 1872 and 1895.
7. You now wish to refine your search by finding only the exhibits in the scientific section of the exhibition year 1873.

To answer these queries requires searching for particular items across different years and in different categories. Coburn was both an exhibitor and a judge and in some cases his work was shown by other exhibitors as in the case of a photograph shown in the 1914 exhibition by David Octavius Hill, based on a paper negative by Coburn. So Coburn is listed under several categories. However, as we have seen, there are inconsistencies in the ways in which information is presented across different categories and this is compounded by variability over time.

The user trials were carried out with relatively small numbers (3-6 subjects per trial), selecting a fresh sample each time to ensure that results were not cross-contaminated by previous exposure to the design. Sample sizes of 3 to 5 users are sufficient to obtain valid results in this kind of test (Nielsen, 1994), even though larger samples are usually required for scientific studies (Bevan et al., 2003). Subjects were an evenly balanced mixture of male and female volunteers, none of whom had any previous knowledge of the project. All were experienced personal computer and Internet users.

For the first trial, volunteers were selected who were not photographic historians to ensure that there was no possibility of over-interpreting the design. In subsequent trials the volunteers were photo historians, researchers and curators, to ensure that they could provide informed comments about the performance of the site. Trials were conducted with one subject at a time. Subjects were told that it was the design, not they that were being tested. They were not told what the site was about. They were asked direct questions about the site and encouraged to voice their thoughts as they were looking at the prototypes and to ask questions if they were unsure about anything. If they asked questions about how to do something they were not given direct answers. Instead they were asked how they thought it might be possible to do it. After the trial each subject was asked for any other comments they had about the site design. Trials were recorded on audio, supplemented by notes and photographs.

4. RESULTS

The results of the first trials indicated that subjects easily understood what the site was about but there was confusion about what functionality the site offered and they were confused by the Boolean search options. Most said they would either just search by browsing or, enter one or two words in the simple search box and then click on "go". A major change resulting from this was the introduction of a form based "guided" search

that was intended to indicate to users the full range of fields that could be searched including lists with drop down menus of all exhibitor titles, RPS membership status, qualifications and affiliations; judges roles, capacities and exhibition sections; exhibit types, processes, prices, medal status, sources, and exhibition sections, as well as drop downs for exhibition dates and free text entry boxes for exhibitor names, addresses, etc. Figure 3 shows one page from the guided search form.

Second round trials were conducted using revised paper prototypes and third round trials employed wire-frame mock-ups of screens (see figure 4 for an example). In both of these rounds most subjects preferred to use the guided search as it provided more information about what kinds of data was available in the database but they were so overwhelmed by the complexity of the interface that they did not notice many of the available search options and found it difficult to select the most appropriate ones for the tasks they were given. Many resorted to selecting the "search all fields" option to be on the safe side and explained that they would then visually scan the results to pick out the relevant hits. In response to this it was decided to simplify the interface by taking some steps towards interpreting the data. For example, the great many different exhibition sections were categorised and a summary list provided in the menu drop downs (see figure 4). Thus many of the items in the list of 22 possible categories were bundled together in a single group called "transparencies".

The screenshot shows a web form titled "Exhibits". It features several search fields: "Exhibit type" (set to "All"), "Title" (empty), "Section" (set to "All" with a dropdown menu open), "Original" (set to "All exhibits"), "Some of" (set to "All exhibits"), "There are" (set to "All exhibits"), "In most of" (set to "All exhibits"), "Occasion" (set to "All exhibits"), and "Search in" (set to "Books"). The dropdown menu for "Section" is open, showing a list of categories: "All", "General Photography", "General Professional Photography", "Colour Photography", "Pictorial Photography", "Scientific and Technical Photography", "Lantern Lectures", "Stereographs", "Transparencies", "Imitation Collections", "Loan Collections", "RPS Permanent Collection", and "Photographic Apparatus and Materials". Below the form, there is a "Word or phrase" search box and a "Find" button. The "From" and "To" date fields are set to "1870" and "1915" respectively.

Figure 4: Simplified drop down menu for exhibition sections

The fourth round of trials was significant in that it was the first time that the prototype was linked to a working database. This enabled the prototype to return much greater numbers of hits in response to search queries and to offer many more exhibit entries than were feasible to draw out by hand in earlier paper based prototypes. (The catalogues contain around 30,000 records so some searches could yield enormous numbers of hits.) The trial results revealed that subjects were still confused but this time because searches were returning large quantities of information they had not realised they had requested. Over-simplification of the data in some cases combined with the link to an actual database resulted in too many false positives.

In retrospect, the transition from scenario-based mock-ups to prototypes connected to a trial database turned out to be more of a step change than anticipated. The simpler paper based and on-screen wireframe mock-ups did not give subjects an adequate impression of the sheer volume of information available and

this compromised some of their responses to the earlier designs. In order to simplify the site some of the associations between different items of information in the database introduced earlier were removed, even though this reduced some of the functionality. For example, a link between awards (which in the catalogues are associated with exhibits) and exhibitors, so that a search for medal winners could be carried out, was abandoned. Similarly an attempt to use information about exhibits to categorise exhibitors as photographic or scientific and technical was abandoned.

Some of the user feedback received since the launch of the final version (<http://erps.dmu.ac.uk>) indicates the extent to which these difficulties were finally resolved:

"I found [*Exhibitions of the Royal Photographic Society 1870-1915*] easy to navigate, fast and efficient, what I found less easy was the multiple forms under which some names appeared but I got used it."

"The alphabetical drop-down listing of exhibitors' names is good, simple and goes some way towards getting around the fact that in many cases there [are] several permutations of names for the same person."

"Ability to refine the search within results was very useful and worked well."

"A fantastic, comprehensive rendering of all the information on RPS exhibitions which is contained in the RPS journals, with the huge advantage of being searchable and making links across journals. The search functions were good – I liked the combination of the ability to browse on several different fields with the more general search. It's possible to approach the database in a [sic] many different ways, depending on whether you are researching a specific photographer, exhibition etc."

5. CONCLUSIONS

This paper has argued that, in addition to large scale, generic, systemic issues such as mass digitisation, automated content capture and data mining, resource sharing, multilingual access and broad frameworks for long term data preservation, successful future access to and use of cultural and scientific resources also depends on micro design factors concerning the usability of individual Web sites. Users frequently cannot find the information they seek on Web-sites generally and even researchers are reluctant to invest time in order to better understand and use resources more effectively. The result of badly designed sites is lost repeat visits, wasted time, reduced productivity, increased frustration, and loss of repeat visits and revenue, increased training and increased support costs.

One way of overcoming such problems is to develop designs which maximise the usability of the resources by promoting their affordances and by making it easier for users to achieve their goals. However, historical, event-based, data such as exhibition catalogues present particular problems because the relationships between entities across different events are relatively weak and the number and type of data categories are likely to change considerably. This creates complexity, ambiguity and uncertainty. Ambiguity and uncertainty can be dispelled to some extent by data interpretation and simplification but doing so can result in corruption of the information and confusion on the part of the user. Managing the relationship between usability, functionality and data integrity is not a formulaic process because different resources are targeted at different user groups which have different needs, expectations and abilities. Resources should, therefore, be tailored to the requirements of their target users.

This study has investigated how a user-centred design approach can be employed to identify user needs and preferences in relation to these issues and to produce an effective Web site design. However the transition from scenario-based mock ups to prototypes connected to a trial database turned out to be more of a step change than anticipated. In retrospect it can be seen that too much reliance on over-simplified paper prototypes compromised the evaluation trial results. In future projects of this kind it is recommended that a combination of scenario and vertical prototypes is employed in parallel to see if this can help to enhance the validity of design decisions based on scenario based paper prototypes alone.

6. REFERENCES

References from Journals:

John, B.E. and Marks, S.J., 1997. Tracking the effectiveness of usability evaluation methods. *Behaviour and Information Technology*, 16(4/5), pp. 188-203.

Manning, H., McCarthy, J., & Souza, R., 1998. Why Most Web Sites Fail. *Interactive Technology Series*, 3(7) pp. 18-24. Forrester Research: September.

Rettig, M., 1994. Prototyping for tiny fingers. *Communications of the ACM*, 37(4), pp. 21-27.

References from Books:

Becher, T. and Trowler, P., 2001. *Academic Tribes and Territories: Intellectual Enquiry and the Culture of Disciplines* 2nd ed., Buckingham: Open University, p. 27.

Nielsen, J., 1993. *Usability Engineering*. Academic Press Limited: London, pp. 58-63.

References from Other Literature:

Bevan, N., Barnum, C., Cockton, G., Neilsen, J., Spool, J. And Wixon, D., 2003. The Magic Number 5: Is it enough for Web testing?. Conference on *Human factors and Computing Systems*, ACM, Fort Lauderdale, Florida, pp. 698-699.

Warwick, C., Terras, M., Huntington, P. and Pappa, N., 2006. If you build it will they come? The LAIRAH Study: Quantifying the use of online resources in the Arts and humanities through statistical analysis of user log data. School of Library, Archive and Information Studies, University College London, pp. 7-11.

References from websites:

Brown, S., Ross, R., Gerrard, D. Greengrass, M. Bryson, J., 2006. RePAH: A User Requirements Analysis for Portals in the Arts and Humanities Final Report. Humanities Research Institute, Sheffield University, UK, pp. 128-129. <http://repah.dmu.ac.uk/> (accessed 20 June 2008)

DigiCult, 2007. Expanding the use of Europe's cultural and scientific resources. http://cordis.europa.eu/fp7/ict/telearn-digicult/digicult_en.html (accessed 20 June 2008)

Henry, S.L. and Martinson, M., 2003. Accessibility on User-Centered Design. Quoted in *Notes on User Centered Design Process* (UCD) W3C Web Accessibility Initiative. <http://www.w3.org/WAI/EO/2003/ucd> (accessed 20 June 2008)

Katz-Haas, R., 1998. Usability Techniques: User-Centered Design and Web Development. http://www.stcsig.org/usability/topics/articles/ucd%20_Web_devel.html#what_is_UCD (accessed 20 June 2008)

Stephen, T. and Harrison, T., 2002. Building Systems Responsive to Intellectual Tradition and Scholarly Culture. *The Journal of Electronic Publishing*, 1, pp 38-43. <http://www.press.umich.edu/jep/08-01/stephen.html>. (accessed 20 June 2008)

Unsworth, J., 2003. The Humanist: "Dances with Wolves" or "Bowls Alone"? paper given at *Scholarly Tribes and Tribulations: How Tradition and Technology Are Driving Disciplinary Change*, Westin Grand Hotel, Washington, D.C., October 17. 2003. <http://www.arl.org/bm~doc/unsworth.pdf> <http://www.arl.org/scomm/disciplines/program.html> (accessed 20 June 2008)

User Interface Engineering, 2001. *People search once, maybe twice*. http://www.uie.com/Articles/search_once.htm (accessed 20 June 2008)

Vergo, J., Karat, C-M., Pinhanez, C., Aroora, R., Cofino, T., Riecken, D., Podlaseck, M., Watson, T.J., 2001. Less Clicking, More Watching: Results From the User-Centered Design of A Multi-Institutional Web Site for Art and Culture. In D. Bearman and J. Trant (eds.) *Museums and the Web 2001: Proceedings*. Toronto: Archives & Museum Informatics, 2001. <http://www.archimuse.com/mw2001/papers/vero/vergo.html>. (accessed 20 June 2008)

7. ACKNOWLEDGEMENTS

The *Photographs Exhibited at the Royal Photographic Society 1870-1915* project was funded by the Arts and Humanities Research Council.

MARKETING HERITAGE: GUIDED THROUGH THE PAST USING GPS NAVIGATION TECHNOLOGIES

D.G. Hadjimitsis* and K. Themistocleous

Department of Civil Engineering & Geomatics, Remote Sensing Lab, Cyprus University of Technology-31 Archbishop Kyprianos, P.O. Box 50329, 3603 Lemesos, Cyprus
*d.hadjimitsis@cut.ac.cy

KEY WORDS: Navigation devices, GPS & GIS technologies, electronic cultural heritage guide.

ABSTRACT:

Cyprus is filled with historical areas of interest from varying periods of history. Finding them, however, is not always easy, and interesting places are often missed or overlooked. The idea behind this abstract is to promote these places and their locations to people via satellite navigation and mobile devices. This would make the experience enjoyable and enriching to the user. The first step would involve identifying cultural heritage sites through mobile navigation devices. As users drive around the island and approach an area of cultural and historical interest, the GPS navigation device would inform the users of this and ask them if they are interested in visiting the area. If the user accepts the invitation, the GPS navigation device will direct them to the area of cultural heritage. As the driver is on the way to this area, the GPS navigation device would detail relevant facts about the area's history via audio and video, in order to contextualize their visit. Most of Cyprus cultural heritage sites are directly accessible by car, so it will be easy to navigate the user to these sites. These devices could then be used to provide further audio and video commentary to users when they arrive at the area via speakerphone. This would remove the hassle of finding these areas and provide the users with interesting information about the area, thus enhancing their overall experience. The users could utilise such new technologies in their car on a daily basis.

1. INTRODUCTION

1.1 GPS navigation technology significance for the cultural heritage sites

Advancements in technology have changed the way we travel and plan our trips. While computing devices are getting smaller, smarter, and more connected, any time and any access to any information during a trip is becoming a reality (Weiser, 1994). Anecdotal evidence confirmed that with the ubiquitous information access and more hectic life styles, travellers plan less and less ahead of a trip and engage in more on-route and in-destination planning (Fesenmaier & Vogt, 1992; Fesenmaier, Vogt, & Stewart, 1993). For example, travellers frequently call hotels to reserve a room while in the car or check out adjacent attractions while touring a city. Ad-hoc decisions on restaurants or attractions are also a part of the fun during a trip which can create pleasant surprises. However, travellers still could not access all the travel related information as they wish. For example, if a traveller walks around Limassol or Paphos in Cyprus and sees a castle, he would like to know when it was built, and its architectural and historical significance. He could not obtain this information without joining a tour group or having a tourist guiding book with him. Additionally, travellers to Cyprus complained about the flawed traffic signs and busy traffic conditions. These types of information can also be delivered to a traveller in real-time through wireless and location-sensitive information access. GPS (Global Positioning System) based technology could provide a solution.

The goal of the proposed project is to build and test a GPS-enabled handheld navigation and information device for the visitors to tour cultural heritage sites in Cyprus. The device will provide visitors with location-sensitive texts, images, audios,

and videos based on their actual physical locations. The technology could increase the visitors' satisfaction about the destination, promote more visitations to different attractions, increase sales on food, entertainment and attractions, and foster more loyal visitors. Potentially the devices could become a source of information and provide easy access to the visitors promoting the cultural and heritage significance of the archaeological and historic sites for Cyprus.

1.2 Theoretical foundations

People engage in cognitive mapping as they collect, organize, store, remember and utilize information about their surrounding environment. Travellers build cognitive maps of the destinations through direct experience, roadside signs and tourist maps (Downs & Stea, 1977; Guy, Curtis, & Crotts, 1990). Research (Grossbart & Rammohan, 1980; Holahan & Dobrowolyn, 1978; Guy, Curtis, & Crotts, 1990) has shown that cognitive maps could substantially influence consumer's commerce or interactions with the environment, including exploring, touring, shopping, purchasing, and patronage. However, one of the most important tool for building cognitive maps, the physical tourist maps, are usually static, limited in the volume of information, and could be complicated to use for the first-time visitors because the unfamiliarity with the orientation and layout of the city. We hypothesize that location-based information could help visitors to build cognitive maps more quickly and in more details. As a result, those visitors will be more engaged, visit more attractions, spend more on food and entertainments, achieve a higher satisfaction, and become more loyal customers.

2. ELECTRONIC TOUR GUIDE

Our approach is to develop a GPS navigation interface for cultural heritage in Cyprus by entering location data (maps, directions and multimedia) to GPS navigation devices. The GPS navigation device has tremendous potential in the tourist industry, as its use is not limited to navigation. Using GPS navigation devices for cultural heritage navigation and location retrieval and pop-ups about places of interests; we can deliver maps, text, images, audio and video to users with a handheld device. The unit is able to provide music, photos, video and e-books to the user in their choice of 16 languages.

Thus, prospective visitors touring Cyprus could borrow a GPS-enabled device to learn about archaeological sites, castles, churches, and other cultural heritages sites through a video, read relevant e-books about the area of interest, see corresponding photos and hear relevant music. For example, a visitor to Curium theatre, build by the Roman Empire, could use the GPS unit to navigate their route to Curium. Once there, they could watch a video about the history of Curium area, access e-books referring to Curium theatre, listen to music and watch video that has been played at the theatre or see photos of reconstruction of buildings and artefacts found at the theatre area. While some of this information could be made available from the World Wide Web, accessing information through a computer at home is devoid of the contextual information that brings the information to life. Making this information simultaneously available and organized by the physical surroundings of Cyprus adds dimensionality and brings the information back into context. While a traveller is driving or walking in a city or village, an audio message or video could offer an introduction to that place right in front of the visitor. Such location-based information opened many opportunities for real-time marketing for tourism organizations. Such an inclusive use of the device has the potential to increase tourist satisfaction with their holiday.

The GPS navigation device is not limited only for use by tourists to access archaeological or historical sites in Cyprus. Such a unit can also be used by locals to provide directions and information about the myriad of churches found in the island. The idea of a pilgrimage to picturesque churches and monasteries around the island is popular among Greeks and Greek-Cypriots; what is often lacking is a context regarding the history of the particular church. The GPS navigation device could fulfil this need and provide local travellers with useful information.

Another use for the GPS navigation device is geocaching. Geocaching is the most popular GPS game in which visitors with GPS devices need to locate certain artefacts hidden by previous visitors through location information. These gaming experiences in physical space can add another dimension to tourist experience to cultural heritage sites. At present, such games have not been developed with cultural heritage information—this is a need that can be addressed in the future by the tourist industry.

In addition, the GPS navigation device could collect all the information about visitors' physical locations across their entire trip. This would provide invaluable information to tourism researchers regarding visitor's behaviour on the island. It also has the potential to provide feedback and quality control for tourism organizations regarding their performance.

3. GPS TECHNOLOGIES

GPS stands for the Global Positioning System, which is a navigational system that is made up of satellites that are able to locate a receiver anywhere on earth. Satellite navigation is a method employing a Global Navigation Satellite System (GNSS) to accurately determine position and time anywhere on the Earth. Satellite navigation receivers are currently used by both private individuals and businesses for positioning, locating, navigating, surveying, and determining the exact time in an ever-growing list of personal, leisure and commercial applications. Using a GNSS system the following values can accurately be determined anywhere on the globe (Figure 1):

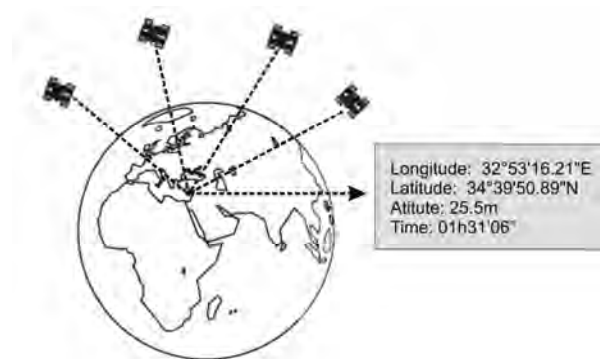

Figure 1: The basic function of satellite navigation

- (1) Exact position (longitude, latitude and altitude co-ordinates) accurate to within 20 m to approx. 1 mm.
- (2) Exact time (Universal Time Coordinated, UTC) accurate to within 60ns to approx. 5ns.

Speed and direction of travel (course) can be derived from these values, which are obtained from satellites orbiting the Earth. (Figure 2)

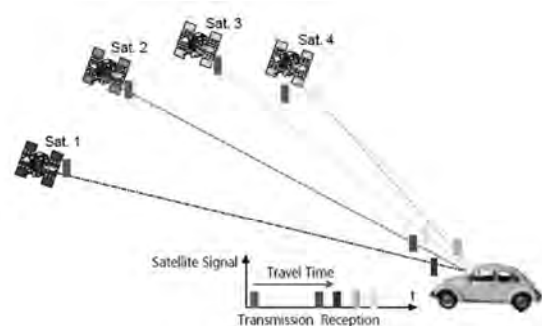

Figure 2: Four satellites are needed to determine Longitude, Latitude, Altitude and Time

As GPS technology has become more compact and portable, there has been an increase in the number of individuals who are enjoying the benefits of GPS units. These devices are typically designed for outdoor use and are a great safety measure. These lightweight, hand-held devices can provide local information, topographic details, as well as other information that is considered important. The handheld GPS systems are quite affordable and there are now many different brands on the market. The only set back with a handheld device is that the

memory can be limited, although there are more expensive models that can have up to 16MB of memory. These types are very powerful and have more features than standard models.

There are four types of GPS-enabled technologies relevant to this project: software with GPS Locator for using in computers; standalone GPS device used in automobiles; GPS Card used in handheld device; and GPS-enabled smart phones. The major producers of GPS systems are TomTom, Garmin, and Magellan. The handheld GPS devices can be easily purchased online, electronics or specialty shops. Handheld GPS devices are in demand from the likes of cyclists, travellers, hikers, fishermen and skiers. The performance of the models can vary, depending on what database and software is installed. Most of the devices are easy to use, as the display screen has all the basic instructions regarding the use of the device. A variety of the handheld GPS devices are voice enabled, which make them useful for driving.

4. SIGNIFICANCE OF THE PROJECT

As stated earlier, the technology has the potential to significantly affect the tourist industry in Cyprus, by increasing visitor satisfaction about the destination, promote more visits to different attractions, increase sales of food, entertainment and attractions, and foster more loyal visitors. This technology can become a revenue source for Cyprus tourism.

In this paper, we propose a personal navigation system for cultural heritage tours. In general, when planning a travel schedule, there are the following requirements as tourists want to (1) efficiently travel multiple destinations as many as possible; (2) choose the content and type of cultural or other destinations they wish to visit and (3) select the best subset of all candidate destinations considering various restrictions if there is not enough time to visit all of them. When a tourist specifies starting location, departure time, returning location, arrival time and multiple candidate destinations with relative importance degrees and time restrictions on arrival and staying time, a nearly best schedule can be computed.

The GPS navigation device could efficiently navigate the tourist according to the decided schedule through a portable computing device with GPS. (Figure 3)



Figure 3: GPS navigation unit

In addition to the popular map-based navigation, it provides temporal guidance (e.g., showing remaining time to departure at each destination) for the tourist to follow the schedule. Moreover, it can automatically modify the schedule when the tourist can not follow the schedule due to some reasons (e.g., delay by traffic jam, intentional change of next destination/staying time, and so on). The GPS navigation device detects such a context change by monitoring the current location and time, and automatically modifies the schedule for the remaining destinations. When the schedule is modified, the system displays the alert on the screen and the user can follow the new tip path. If the user does not like the modified schedule, he/she can recompute the schedule after modifying candidate destinations.

4.1 Planning A Travel Schedule

To plan a schedule with the GPS navigation device, a user may have to input a lot of information; therefore, the user interface is important. We have adopted a pen and touched screen based user interface since most people can learn the operation via web browsers quickly and intuitively (Cheverst, Davies, Mitchell, Friday, & Efstratiou, 2000). We have implemented a user interface as shown in (Figure 4)



Figure 4: interface menu

where data items are input using on-screen keyboard and selection items. In our interface, each user inputs the tour information in the following two steps: (1) the user inputs candidate destinations by selecting them in a predefined destination list or by selecting the destination address, area or city, street name and number. The user can add destinations not in the list by inputting the corresponding latitude/longitude, name, and so on.

When planning a travel schedule using the GPS navigation device, it is likely that the user will modify some relative importance degree and/or staying time and schedule is re-computed repeatedly. The schedule is also re-computed during the tour due to context changes. Accordingly, the computation time should be reasonably small (e.g., less than 10 seconds). However, the above problem which computes the optimal route including multiple destinations with restrictions is a superclass of TSP (Travelling Salesman Problem) which is known as a NP-hard problem, and thus it takes much computation time to obtain an optimal solution. So, we have developed a route search engine to obtain a semi-optimal

solution quickly using techniques of generic algorithms. The engine has been developed as a Java Servlet and can be used from PCs and portable devices via HTTP protocol. Our experimental results show that our route search engine can compute a reasonable travel Schedule in about 5 seconds when 30 candidate destinations are specified, and re-compute another schedule after modifying destinations and restrictions in less than 1 second, where the difference between the obtained solution and the optimal solution is within 2%.

The planning travel schedule function allows a user to plan the nearly best travel schedule which includes a subset of specified candidate destinations and a route to visit the subset of all destinations satisfying specified restrictions. Factoring in for restrictions, the GPS navigation device treats the total time for the tour, geographical distances between any two destinations, user's moving speed, and timeliness at each destination. In order to plan a schedule, the GPS navigation device requires a user to input (1) starting/returning location, (2) destinations location, and (3) relative importance of each destination in terms of travel sequence. In order to facilitate the user input, recommended candidate destinations with importance of travel (registered in the database) are automatically added to the input. The user can remove those destinations at any time. From the above input, the GPS navigation device computes a schedule consisting of (i) a set of destinations and the route to visit all of them, and (ii) the expected arrival time and the departure time at each destination. The GPS navigation device shows the output to the user. (Figure 5)



Figure 5 GPS navigation graphical output

The navigation is provided through a graphical interface with three modes: route *path*; *moving*; and *staying*. When the departure time comes, the system prompts the user and automatically switches to *moving* mode. Switching between *moving* and *staying* modes is automatically done by monitoring the current location obtained by GPS and the present time. The route is computed so that the moving time between two destinations is calculated by dividing the distance of the shortest path (obtained by the software algorithm) between those destinations by the user's moving speed and direction. We have designed and implemented a fast route search engine based on the techniques in generic algorithms used by the GPS hardware and software.

5. CONCLUSIONS

In this paper, we proposed a personal navigation system for cultural heritage sites targeted for tourism. The GPS navigation device provides a user with functions (1) for planning his/her schedule to efficiently visit multiple destinations based on the shortest route available, (2) for navigating a user according to the planned schedule through a portable device with GPS, and (3) for modifying the schedule automatically during the trip if the system notices that the user cannot follow the schedule.

We have designed and implemented a fast route search engine using generic algorithm. On experiments using a digital map on the market, the time for computing a schedule for a typical scenario is about 5 seconds. The time for re-computation after modifying the user input is less than 1 second. We believe that these results are reasonable for the market that the GPS is targeted for.

We have designed the GPS navigation device as a portable device to promote the cultural heritage sites in Cyprus and provide the users the ability to plan, travel and visit on their own with the need of a tour guide. The GPS navigation device will provide audio and video information of all cultural heritage sites. In our current implementation of the GPS navigation device, we suppose that users move between destinations by a single mean of transportation (e.g., by car or by walk). As part of future work, we are planning to add all cultural heritage sites, hotels, restaurants, museums, and other places requested by the users.

6. REFERENCES

- Arnaud A. (1993) Impact of GIS on a southern European country: the cases of Portugal. In *Diffusion and Use of Geographic Information Technologies*, edited by I. Masser and H.J. Onsrud. Dordrecht: Kluwer.
- Baus, J., Krüger, A., and Wahlster, W. (2002). A Resource Adaptive Mobile Navigation System., *Proceedings of IUI2002: International Conference on Intelligent User Interfaces 2002*, ACM Press, New York.
- Butz, A., Baus, J., Krüger, A., Lohse, M. (2001). A Hybrid Indoor Navigation System., *Proceedings of IUI2001: International Conference on Intelligent User Interfaces 2001*, ACM Press, New York.
- Cheverst, K., Davies, N., Mitchell, K., Friday, A. and Efstratiou, (2000). Developing a Context - Aware Electronic Tourist Guide., *Some Issues and Experiences. Proc CHI 2000*.
- Downs, R.M., & Stea, D. (1977). *Maps in minds*. New York: Harper and Row.
- Ehlers, M., Jung, S., and Stroemer, K. (2002). Design And Implementation Of A Gis Based Bicycle Routing System For The World Wide Web (Www). *International Symposium on Geospatial Theory, Processing and Applications (ISPRS2002)*.
- Fesenmaier, D., & Vogt, C.A. (1992). Evaluating the utility of touristic information sources for planning Midwest vacation travel. *Journal of Travel & Tourism Marketing*, 1992, 1(2): 1-18.

Fesenmaier, D., Vogt, C.A., & Stewart, W.P. (1993). Investigating the influence of welcome center information on travel behavior. *Journal of Travel Research*, 31(3): 47-53.

Grossbart, S.L., & Rammohan, B. (1980). Cognitive maps and shopping convenience. In K. Moore (Eds). *Advances in Consumer Research*, Association for Consumer Research.

Guy, B.S., Curtis, W.W., & Crotts, J.C. (1990). Environmental learning of first-time travelers. *Annals of Tourism Research*, 17: 419-431

Holahan, C., & Dobrowolny, M.B. (1978). Cognitive and behavioral correlates of the spatial environment. *Environment and Behavior*, 10(3): 317-333.

IST, .CRUMPET (2008). Creation of User-friendly Mobile services Personalised for Tourism., <http://www.ist-crumpet.org/>

Kanoh, H., and Nakamura, N. (2000). Route Guidance with Unspecified Staging Posts using Generic Algorithm for Car Navigation Systems., *IEEE Conference on Intelligent Transportation Systems (ITSC 2000)*.

Korf, R.(1990). Real-Time Heuristic Search., *Artificial Intelligence*, 42 (2-3): 18- 211.

Malaka, R., and Zipf, A. (2000). DEEP MAP - Challenging IT research in the framework of a tourist information system. *ENTER 2000, Barcelona, Spain*.

Weiser, M. (1994). The world is not a desktop. *Interactions*, 1(1): 7-8.

Zipf, A., and Malaka, R. (2001). Developing Location Based Services (LBS) for tourism – The service providers view. Information and Communication Technologies in Tourism. *Proceedings of ENTER 2001, 8th International Conference. Montreal. Springer Computer Science. Wien, NewYork*.

Spatial Information Management for Cultural Heritage

DEVELOPMENT AND USE OF A 4D GIS TO SUPPORT THE CONSERVATION OF THE CALAKMUL SITE (MEXICO, WORLD HERITAGE PROGRAMME)

M. van Ruymbeke^a, V. Tigny^b, E. De Bads^b, R. Garcia-Moreno^a, R. Billen^{a,c}

^a University of Liège, European Centre of Archaeometry, Allée du 6-Août 17, B 4000 Liège, (mvanruymbeke, RG.moreno)@ulg.ac.be

^b GIM, Researchpark Haasrode, Interleuvenlaan 5, B 3001 Heverlee, (vincent, erik)@gim.be

^c University of Liège, Geomatic Unit, Allée du 6-Août 17, B 4000 Liège, (rbillen)@ulg.ac.be

KEY WORDS: ICT, GIS, World Heritage, Archaeology, Remote Sensing

ABSTRACT:

The present project proposes to develop and implement an information management system for the conservation authorities of the Biosphere Reserve and Archaeological Urban Centre of Calakmul. This online system will allow Mexican managers and scientists to store, share and create interaction between their data, in order to coordinate various actions of conservation, management, planning, monitoring and research undertaken in the reserve. It will benefit from new developments in the GeoICT, Archaeomatic and Spatio-temporal Analysis, Computer Vision and Earth Observation fields and will integrate 2D GIS layers, 3D objects and time. An innovative scientific protocol is proposed to incorporate in a GIS complex archaeological data.

1. INTRODUCTION

1.1 Aims

Formed at the beginning of the twentieth century, the name “Calakmul” refers nowadays to three different entities: an ancient Maya city, an ecological reserve and a municipality. The described project concerns the two former entities. The study zone lies in the South East of the Campeche State, in the middle of the Yucatan peninsula (Mexico).

The Calakmul biosphere reserve was created in 1989. It covers an area of almost 7.300 square kilometres and constitutes one of the largest protected forests of the tropical zones. It shelters rare species of flora and fauna. It also includes many archaeological sites, Calakmul being the most important one. This pre-Colombian city has been registered on the World Heritage List (cultural part) in 2002.

Within recent years, settlement pressure, farming and new extraction of commercial timber caused threats to this natural and cultural heritage. In order to help the Mexican authorities INAH (Instituto Nacional de Antropología e Historia) and CONANP (Comision Nacional de Areas Naturales Protegidas) to preserve it, UNESCO – World Heritage Programme proposed to make use of Belgian expertise to assist the preservation and conservation management of the area. Accordingly, four research teams (3 University laboratories, 1 private company) were selected and funded by the Belgian Science Policy Office (BELSPO) and formed a consortium in charge of the project.

1.2 Description

The so called “Development and use of a 4D GIS to support the conservation of the Calakmul site (Mexico, WHP)” project started in December 2007. Following UNESCO requirements, the consortium proposes to develop and implement an information management system for the conservation authorities of the Biosphere Reserve and Archaeological Urban Centre of Calakmul. This system will allow Mexican managers

and scientists to store, share and create interaction between their data, in order to coordinate various actions of conservation, management, planning, monitoring and research undertaken in the reserve. It will also assist them in their reporting activities and to apply for a nomination (“mixed site”) at UNESCO in the framework of the World Heritage Convention. Within this scope, the 4D aforesaid system means: handling of usual 2D, plus time, plus 3D models for some specific works of art like stelae or small buildings.

2. 4D GIS?

2.1 Concept

The present project is based on the use of new technology and scientific developments for the conservation of natural and cultural heritage. Thus it will benefit from new developments in the GeoICT, Archaeomatic and Spatio-temporal Analysis, Computer Vision and Earth Observation fields.

The information management system will indeed be an online tool with integration of:

- 2D GIS layers and 3D objects,
- large and small scales layers,
- time.

To do so it will use recent advancements and emerging open standards, but also innovative method and data models to integrate archaeological data and carry out spatio-temporal analysis. It will combine new computer vision techniques to produce 3D models of buildings and works of art from digital photograph sequences.

Finally, it will use newly available Formosat 2 satellite images to investigate the possibilities to document Maya ruins: buildings or evidences of man-made structures.

The information management system will be used as the main data repository to store all data referring to the archaeological

inventory, the individual cartography for Calakmul and the cartography of the large nature protection area. This tool will have the following capabilities:

- Manage and visualise data, small and large scale at the time, in 2D and 3D.
- Monitor processes, like e.g. the restoration of the site and the land use changes in the surroundings.
- Perform spatial analysis, for the purpose of regional and local planning.
- Facilitate reporting (at national level and towards UNESCO (WHP/MAB...))

The project is divided into three main phases, which are:

- the data procurement,
- the software development, preceded by a requirements analysis and a service description, and
- the capacity training of the Mexican partners.

Each of the three phases is subdivided into a cultural and an ecological aspect due to the different user-groups and scales.

However, as the project has just started, technical choices concerning the system and open standards to be used (eg 2D Map Viewer with time slider coupled with a Content Management System; information models and data formats for 3D GIS: Collada, X3D, CityGML, etc. and OGC WebServices) have still to be taken based on the user requirements analysis. After this short description of the whole project, we will thus basically focus hereafter on the Cultural Heritage data modelling question and on the use of Earth Observation data for documenting archaeological evidences.

2.2 GIS, Remote Sensing and Cultural Heritage

Remote Sensing offers many useful and sometimes indispensable data that can be integrated in a GIS for the mapping, monitoring and management of World Heritage sites, either natural (parks, landscapes...) or cultural (monuments, archaeological sites...). GIS and Remote Sensing are thus excellent tools to support the monitoring process that is required for the good conservation of World Heritage sites (BELSPO, 2002).

With respect to Cultural Heritage and archaeology, as far back as the middle of the eighties, Anglo-Saxon archaeologists were the firsts to take advantage of Geographical Information Systems (GIS), especially in a predictive modelling perspective. During the nineties, professionals involved in inventories of Sites and Monuments found in GIS a particularly attractive technology offering a map-based representation of sites' locations. Then came interest for spatial analysis dedicated to archaeological questions (Wheatley & Gillings, 2002).

Having overtook the technological appropriation phase, scientists are henceforth debating about theoretical concepts subtended their researches on GIS. Indeed, initial 2D representation gives way to an increasing involvement of volume and time dimensions, although current GIS vendor solution do not allow such variety of dimensions (Lefebvre, 2006).

On the other hand, it is more and more admitted that, in speaking of the Cultural Heritage domain, the principal

challenge lies, not so much in collection or geo-localization or even modelling of the data, but in the manner of processing related non spatial information (Blaise & Dudek, 2006).

With respect to Remote Sensing, very high resolution satellite images can be used to monitor archaeological remains or to map large sites not covered by vegetation thus providing valuable information for Cultural Heritage management as well.

Consequently the advantages of GIS and Remote Sensing for World Heritage Conservation are numerous (BELSPO, 2002):

- They become a valuable tool to assist conservation activities.
- All information is exactly localised and gathered in one tool.
- Information can be continuously updated.
- Better decision making by spatial analysis.
- Possibility of direct extraction of thematic maps for terrain use.
- Digital handling of data.

3. DATA

3.1 Archaeological data

3.1.1 History of discoveries: Inhabited for more than 1500 years, left and even forgotten since the end of the ninth century, the Maya archaeological site of Calakmul was rediscovered in 1931 by an explorer: Cyrus L. Longworth. Longworth was employed by a chicle exploitation firm and informed of the existence of archaeological evidences by two chicle workers. Inspired by the two high pyramids emerging from the forest, he called the city, by using the still common Maya language: Ca (two), Lak (nearby), Mul (mound). However, epigraphers are now almost sure that the old name of the city was "Kaa Nal", the (head) snake (Marcus, 1973).

The first cycle of real archaeological records took place in 1932, under the supervision of Sylvanus G. Morely, sponsored by the Carnegie Institute. Subsequent researches have been done by several teams. First of them directed their attention to topographical and mapping survey. Excavation operations really began in 1984, with William J. Folan (Universidad Autonoma de Campeche - UACAM), and since 1994 by Ramon V. Carrasco (INAH). To add to this, international teams are nowadays cooperating with Mexican scientists on some specific spots. (Giorgi & alii, 2006; Niccolucci, 2006; Šprajc, 2008).

The results of their works, combined with epigraphic studies, historical analysis and other knowledge domains, shows that we are in front of a very important place. Indeed, during its apogee at the early classic period, Calakmul was the largest city of the Maya region and had to assure its hegemony by any means, peaceful or not. It was a feared jungle chieftain until the end of the seventh century A.D. when Jaguar Paw, king of Calakmul, was defeated after a bloody battle against Tikal, the rival city. From that moment on, began the slow decline of the head snake kingdom (Folan & alii, 2001; Vidal-Angles & Domínguez-Turizza, 2003).

3.1.2 The urban centre (Figure 1): Spread over an area of 30 square kilometres, with more than six thousands archaeological structures, most of them only faintly drawn on a plan but not excavated, the city appears like a vanished urban centre now covered with vegetation. The core of the town has been built upon a great natural flat-topped hill, partially lain out to base platforms of pyramids, palaces and other temples.

Those buildings are split up into several poles: a central place and smaller groups placed in spokes (Folan & alii, 2001; Vidal-

Angles & Domínguez-Turizza, 2003). As it is now, the site remains like it was before its disuse, during the Late Classic period. But the most surprising thing lies under the facades: each monument hides - and fortunately protects - one or more earlier building phases, often magnificently well preserved. On account of this, Calakmul is seen as an unrepeatable testimony of the daily life of a gone civilization: wall paintings, low reliefs, decorated ceramics depict unexpected scenic aspects like, for example, the funerary rituals.

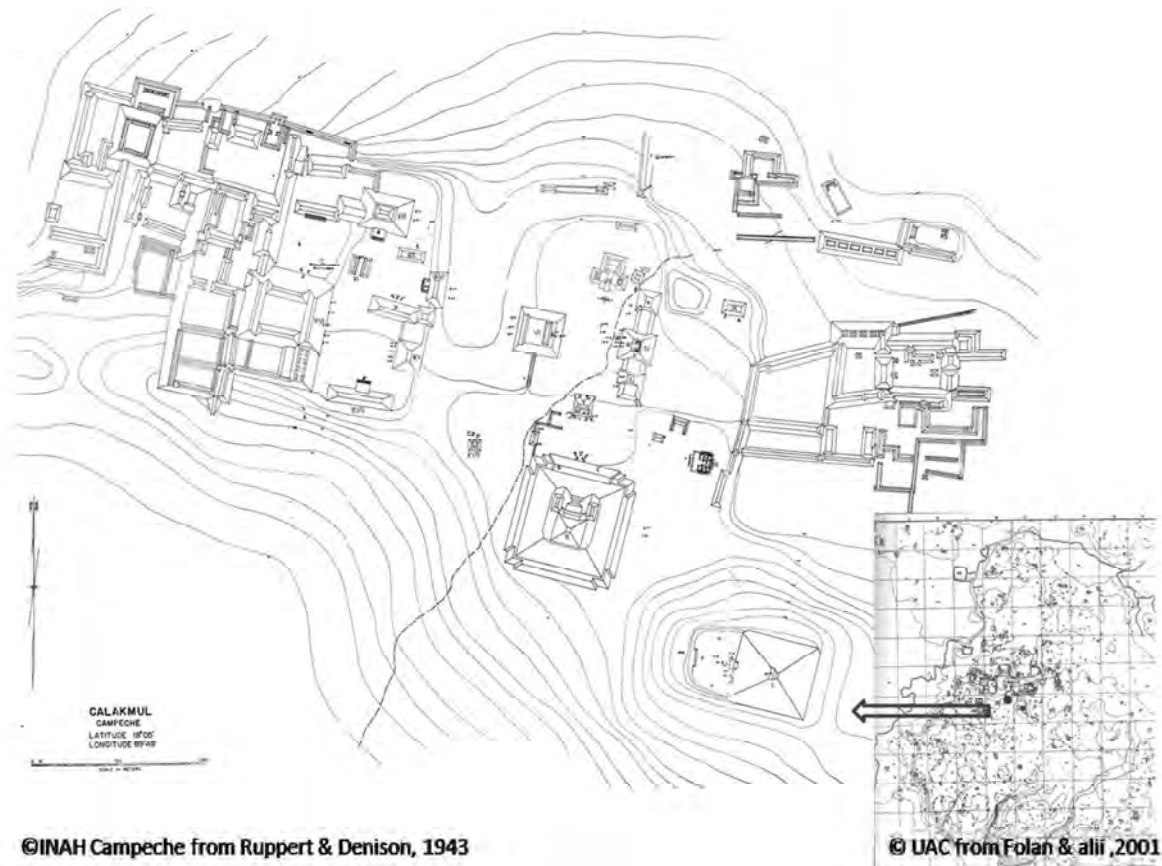

Figure 1: The main place of the urban centre

3.1.3 Complex data: To incorporate in a GIS such an intricate reality, it is necessary to find a way to build an efficient data model. This model will enable to handle architectural buildings, with their geometrical component (in 2D), but above all to link them with quintessence of scientific cognitions collected about them. This knowledge concerns mainly questions of function, time, agent, influences, technical observations, contextual data and documentation.

Another difficulty resides in the fact that more than one of these aspects may be applicable for one object: the function may be major, minor, incidental or symbolic. The time may be the construction one, the use or disuse one, it can be a date or a duration, it can be absolute or relative. Agents embedded in this model will be gods, kings, priests, artists, archaeologists, epigraphers, while the influences bring together notions like cultural traditions, technical advancement, religious or political currents and historical events.

The technical observations will manage the question of material, making process, preservation condition and damage description. The contextual data refer to relations supported by objects towards other objects, archaeological or not. At least, documentation part comprises things like bibliography, iconography, excavations' evolution and so on.

Moreover, two specificities characterize archaeological data: the inherent uncertainty level and the coexistence of contradictory and sometimes conflictive scientific interpretations.

All this information can't simply be stored in an attribute table of a GIS, because then it is possible that the data could not be useful for ulterior requests. It is thus necessary to find a best way to incorporate it.

3.2 Remote Sensing data

Thanks to BELSPO financial support, new Formosat 2 images are currently being acquired. Formosat 2 sensor is a new Taiwanese satellite launched in 2004 that offers 24X24 km images with 2m resolution (PAN – 8m MS). This will allow us to obtain the first very high resolution satellite mosaic over the entire reserve.

4. METHODS

4.1 Models for archaeological data

To model archaeological data, we have planned to put into practice the scientific protocol recently proposed by H. Galinié, X. Rodier and L. Saligny (Galinié & Rodier, 2002; Galinié, Rodier & Saligny, 2004; Rodier & Saligny, 2007). Based on the F. Bouillé's Hypergraph Based Data Structure method (Bouillé, 1977) and the Peuquet's triad (Peuquet, 1994), it requires, using a rigorously formalism, the transformation of heterogeneous data into robust entities (urban objects) delimited by three domains: the spatial, social and temporal features. This method aims at studying urban archaeological contexts, especially to get their dynamics of change. Archaeologists wish indeed to work on heritage, inertia, trajectories, or processes. We thus aim at obtaining an horizontal and vertical vision of phenomena: what does occur at a given time? or which is the evolution of such a place? at least how such a thing does happened?

On that goal, the scientific protocol notably suggests avoiding information redundancies: functional interpretation of an urban object is made by choosing an instance of a hierarchical thesaurus. That choice is reasoned by chronological and spatial contexts of that object. Secondly, spatial entity localises the identified urban object and finally, temporal entity dates it. To avoid redundancies, space and time are deconstructed in small fragments, reusable as often as necessary.

On the other hand, research about ontology undertaken by computer science and geomatics specialists (Zlatanova, 2000; Billen & Zlatanova, 2003) shows promising results and potential solutions with concepts like juridical, fictional and abstract objects. They should be useful to model data without or with incomplete spatial components. For example, we could imagine using that concept for modelling reigns, periods, territories etc...

At last, new triangular model (Van De Weghe & alii, 2007) for time representation will also be tested. Its main characteristic is to conceptualize time like a 2D plane. Consequently, instants and time intervals may be represented and analysed in 2D too.

4.2 Image processing technique

The innovative method chosen here to extract information from satellite imagery is the object-oriented image processing technique. In contrast to traditional image processing methods, the basic processing units of object-based image analysis are image objects or segments, and not single pixels. The classification to produce the land use maps is thus not done on the basis of imagery pixels but on the basis of image objects detected during the segmentation process. This will increase the time-efficiency as well as the potential for products updating since segmentation and classification procedures can be

transformed into standardized protocol and stored to be applied to other datasets.

5. CONCLUSIONS

If the main goal of this project consists in elaborating a whole and efficient integrated system combining various data, its major scope concerns Cultural Heritage in all its complexity. Incomplete knowledge, uncertainty, contradictory data will feed a tool supposed to manage more standardized questions. To take them into consideration, we will have to customise a number of scientific issues *a priori* dedicated to other fields of research. To do so, cooperation between Belgian and Mexican partners, know-how and knowledge transfer, flexibility and cleverness will be necessary. By bringing to fruition all those challenges, this project will produce results reusable for other Cultural Heritage sites.

6. REFERENCES

- BELSPO, 2002. Remote Sensing and GIS in support of World Heritage Conservation. <http://telsat.belspo.be/whp/remotesensing.html>
- Billen R., Zlatanova S., 2003. 3D spatial relationships model: a useful concept for 3D cadastre ? *Computers, Environment and Urban Systems* 27, pp. 411- 425.
- Blaise J.-Y., Dudek Y., 2006. Modélisation informationnelle: un cadre méthodologique pour représenter des connaissances évolutives spatialisables. *Extraction et Gestion des Connaissances 2006*, vol. 1, *Revue des Nouvelles Technologies de l'Information E-6*, Lille, pp. 347-358.
- Bouillé F., 1977. *Un modèle universel de banque de données simultanément partageable, portable, répartie*. Thèse d'Etat es Science, Université de Paris VI, Paris.
- Folan W.-J., Fletcher L., May Hau J., Florey-Folan L. (coord.), 2001. *Las Ruinas de Calakmul, Campeche, Mexico : Un lugar central y su paisaje cultural*, UAC, CIHS.
- Galinié H., Rodier X., 2000. TOTOPI Topographie de Tours Pré-Industriel, un outil d'analyse urbaine. *Les petits cahiers d'Anatole11*. http://citeres.univ-tours.fr/doc/lat/pecada/F2_4.pdf
- Galinié H., Rodier X., Saligny L., 2004. Entités fonctionnelles, entités spatiales et dynamique urbaine dans la longue durée. *Systèmes d'information géographique, archéologie et histoire, Histoire et Mesure* XIX, 3/4, p. 223-242.
- Giorgi R., Chelazzi D., Carrasco R., Colon M., Desprat A., Baglioni P., 2006. The Maya site of Calakmul : « in situ » preservation of wall paintings and limestone by using nanotechnologies. *Iic congress 2006: proceedings*.
- Lefebvre B., 2006. Construction et déconstruction de l'espace urbain : une modélisation en volume du bâti ancien. *MIA journal* 2, VII. <http://www.map.archi.fr/mia/journal/>.
- Marcus J., 1973. Territorial Organisation of the lowland Classic Maya. *Science* 180, pp. 911-916.

Nicolucci F., 2006. On-Site ICT Applications in Archaeology. The Calakmul case. *Proceedings of the EVA London conference*.

Peuquet D.-J., 1994. It's about time: a conceptual framework for the representation of temporal dynamics in geographic information systems. *Annals of the Association of the American Geographers* 3, pp. 441-461.

Rodier X., Saligny L., 2007. Modélisation des objets urbains pour l'étude des dynamiques urbaines dans la longue durée. *SAGEO 2007, Rencontres internationales Géomatique et territoire*, CdRom. Série : Aménagement du territoire, AgroParisTech-ENGREF Clermont-Ferrand.

Ruppert K., Denison J.-H. Jr., 1943. *Archaeological Reconnaissance in Campeche, Quintana Roo and Peten*. Carnegie Institution of Washington, Publication 543, Washington D.C.

Šprajc I. (ed.), 2008. *Reconocimiento arqueológico en el sureste del estado de Campeche: 1996-2005*. *BAR International Series* 1742, Paris Monographs in American Archaeology 19, Oxford, Archaeopress.

Van De Weghe N., Docter R., De Maeyer P., Bechtold B., Ryckbosch K., 2007. The triangular model as an instrument for visualising and analysing residuality. *Journal of Archaeological Science* 34, pp. 649-655.

Vidal Angles C., Domínguez Turizza M. (coord.), 2003. *Calakmul Anthologia*, Conaculta – INAH, Campeche, Mexico.
Wheatley D., Gillings M., 2002. *Spatial Technology and Archaeology, the Archaeological Applications of GIS*, Londres et New York, Taylor & Francis.

Zlatanova S., 2000. 3D GIS for Urban Development. *Technical Sciences*. Graz Austria, Graz Austria of technology, p. 222.

7. ACKNOWLEDGEMENTS

The research presented in this paper is carried out in the framework of the "Development and use of a 4D Geographic Information System to support the conservation of the Calakmul site (Mexico)" project which is funded by the international actions program of the Belgian Science Policy Office and supported by UNESCO, INAH, CONANP and UACAM. In addition to ULg and GIM, authors of this publication, this project is carried out in partnership with the Universiteit Gent and the Katholieke Universiteit Leuven.

PHOTO BROWSING SYSTEM FOR SHARING INFORMATION IN ARCHEOLOGICAL RESEARCH

Yosuke Takata^a, Ichiroh Kanaya^b, Kosuke Sato^a

^a Graduate School of Engineering Science, Osaka University, 1-3, Machikaneyama, Toyonaka, Japan –
takata-yo@sens.sys.es.osaka-u.ac.jp, sato@sys.es.osaka-u.ac.jp

^b Graduate School of Engineering, Osaka University, 2-1, Yamadaoka, Suita, Japan –
kanaya@design.frc.eng.osaka-u.ac.jp

KEY WORDS: Photo browsing, GIS, File photo, Mixed reality, archeological research

ABSTRACT:

Archaeologists have been using photographs and maps for planning and reviewing their research at their meeting. However, selecting proper photographs from the collection of field photographs is somewhat time consuming and non-productive. Even worse, the individually taken photographs don't have direct relationship to the map. This means that the archaeologists must put the photographs on the map with proper direction manually for sharing circumstances of the site.

In this paper we present a novel system for interactive browsing/exploring photographs, from pile of photographs, that are automatically located on the map. The experimental result shows effectiveness of the proposed system in terms of sharing information in archaeological research.

1. INTRODUCTION

In archaeology, researchers have been using photographs and plans (or maps) for planning, discussing, reviewing, whenever they need to talk and share information about their site. However, selecting proper photographs from the collection of field photographs is somewhat time consuming and non-productive. Even worse, the individually taken photographs don't have direct relationship to the map. This means that the archaeologists must put the photographs on the map with proper direction manually. In this paper we present a novel system for interactive browsing/exploring photographs, from pile of photographs, that are automatically located on the map.

2. RELATED WORK

Cheap and compact GPS (Global Positioning System) would allow embedding locative metadata to every digital photograph in very near future. Technologies for managing and/or browsing photographs that have such metadata have been developed. Toyoama [1] proposed adding location tags into photographs and then arranging photographs at the points where the original photographs were taken. Snively [2] proposed the photograph browsing technique that extracts the characteristic of the photograph, and arranges in the virtual space the photograph and the position and the posture where the photographs are taken.

Various researches have been performed about interactive systems such as computer-embedded table. Ishii [3] proposed interaction technology that users could physically touch and move some information, under the name of Tangible User Interface. Reitmary [4] proposed the technique that could access information at focused position by putting a PDA (Personal Digital Assistant, kinds of small computer with screen) and a sheet of paper on the provided map.

3. DESIGN OF PHOTO BROWSING SYSTEM

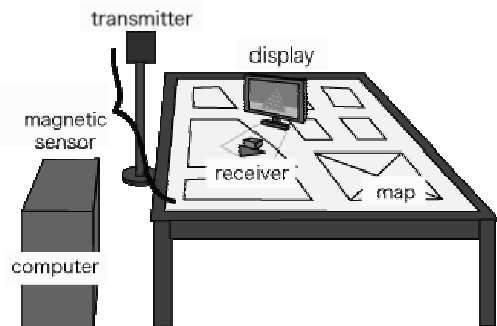

Figure 1: the outline of the photograph browsing system

We innovate the photo browsing system.

The system has the following parts (see Figure 1).

1. A location-aware display that shows photographs.
2. A map of the site.

Users of the system share the map of the site, discuss anything they need, and put the location-aware display on the map to see what they exactly want to see.

This system enables users to access photographs efficiently and quickly by using the position and the attitude of the camera by which the user take photographs and automatic location of the photograph on the map by using computer system.

4. IMPLEMENTATION

Figure 1 shows the outline of the photograph browsing system. We use FASTRAK for sensing the position and the posture of the display. To acquire the position and posture of the display,

the receiver of FASTRAK is attached at the display. The position and posture of the receiver are measured, and the value is used as the position and posture of the display. The measured position and posture information are transmitted to the computer.



Figure 2: implementation of photo browsing system

The computer selects the photograph by using the position and posture information of the display, and displays the photograph on the display. Figure 2 shows the actual system.

5. USER STUDY

We have conducted user studies to evaluate the photo browsing system. Nine subjects participated in the user studies. All of them were students in the computer science department of our university. They were asked to browse photographs five times by using the photo browsing system freely and to answer the following questions.

Question 1: intuitional and quick access to photographs (1: bad ~ 5: good)

Question 2: intuitional presentation of the relation between photographs and map (1: bad ~ 5: good)

6. RESULTS

The results of the questions are indicated at Figure 3 and Figure 4. From the results, it can be said that the photo browsing system is efficient for the problems that participants can't find the photos easily which were taken in needed places, and that they have troubles in recognizing the relationship between photos and maps. So, the photo browsing system is proved to be useful for efficient data sharing between participants.

7. CONCLUSIONS

In this paper, we have described a photograph browsing system for investigator's efficient information sharing in a meeting.

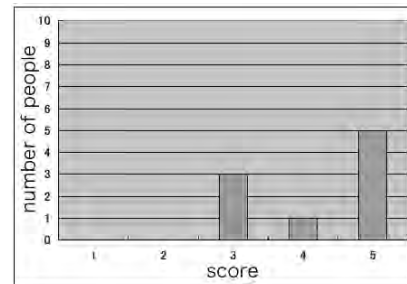

Figure 3: the result of the question 1

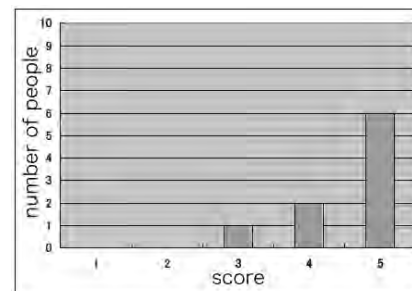

Figure 4: the result of the question 2

In the system, the position and the posture of the photograph are used which are very important and frequently used in archaeological investigation.

The system enables users to access a photograph in a target quickly by inputting the position and the posture of the photograph, and recognize the relation between the photograph and the map by intuition. By user study, it is proved that the system enables the quick access to a photo and intuitive presentation of a photograph. Therefore it can be said that the photograph browsing system is effective for data sharing in the meeting.

8. REFERENCES

References from Journals:

B. Ullmer and H. Ishii., 1997. The metaDESK: models and prototypes for tangible user interfaces. In: *Proceedings of the 10th annual ACM symposium on User interface software and technology*, pp.223-232.

G. Reitmayr, E. Eade, and T. Drummond., 2005. In: *Localisation and Interaction for Augmented Maps. IEEE ISMAR 2005*.

K. Toyama, R. Logan, and A. Roseway., 2003. Geographic location tags on digital images. In: *Proceedings of ACM Multimedia*, Vol.3, pp.156-166.

N. Snavey, S.M. Seitz, and R. Szeliski., 2006. Photo tourism: exploring photo collections in 3D. In: *ACM Transactions on Graphics (TOG)*, Vol.25, No.3, pp.835-846.

INTEGRATING SATELLITE REMOTE SENSING AND SPECTRO-RADIOMETRIC MEASUREMENTS FOR MONITORING ARCHAEOLOGICAL SITE LANDSCAPES

D.G. Hadjimitsis^{1*}, K. Themistocleous¹, M. Ioannides² and C.R.I Clayton³

¹ Department of Civil Engineering & Geomatics, Remote Sensing Lab, Cyprus University of Technology-31
Archbishop Kyprianos, P.O. Box 50329, 3603 Lemesos, Cyprus

*d.hadjimitsis@cut.ac.cy

² Higher Technical Institute, Nicosia, Cyprus.

³ Department of Civil Engineering and the Environment, University of Southampton, Highfield, Southampton, SO17
1BJ, UK.

KEY WORDS: satellite remote sensing, spectral signature, spectro-radiometric measurements, archaeology

ABSTRACT:

This paper explores the beneficial integration of both satellite remote sensing and in-situ spectroradiometric measurements for improving the available post-processing techniques in monitoring landscape changes in the vicinity of archaeological sites. The study has been conducted in the Kato Paphos archaeological area in the Paphos District area in Cyprus. Spectral signatures of different target areas have been measured in-situ using the GER1500 and SVC HR-1024 field spectro-radiometers. Classification and change-detection techniques have been applied for the available archived Landsat TM images and high-resolution Quickbird and IKONOS images.

1. INTRODUCTION

Archaeological studies have a long tradition of aerial photography application (Barnes, 2003). What has been changed in recent years about remote sensing application is the development of new sensors (in particular multi-spectral Pavlidis *et al.*, 2001; hyper-spectral such as Cavalli *et al.*, 2003; microwave) and the availability of new tools for the management and integration of spatial information. Despite good archaeological results, there is a considerable reporting of the inherent limitations of this method of survey. The main problem is the cartographic nature of the data and the impossibility of planning the flights to coincide with "time windows" when conditions for the detection of archaeological features are at their best (Campana, 2007). Satellite remote sensing can provide a variety of useful data for monitoring and managing archaeological sites (Miller and Lee, 1991; Fowler, 2002; Hadjimitsis *et al.*, 2005; 2006; 2007). Satellite image data provide a synoptic view which is not available from aerial photography. It takes over 200 aerial mapping photos to cover the same area as a single satellite image.

The importance of applying space technology to cultural heritage and archaeological research has been paid great attention worldwide, mainly because very high resolution (VHR) satellite data such as, IKONOS (1999) and QuickBird (2001), are able to match with aerial photogrammetric images (Lasaponara and Masini, 2005).

The extent of the problem of the changing landscape nearby the archaeological sites is mostly unknown, however, and efficient coping strategies are not developed. In this paper we present an overview of the basics of the application of remote sensing in such tasks. Indeed, change detection method based on the use of the Normalized Difference Vegetation Index (NDVI), classification, image-overlay applied to Landsat TM images with different acquisition dates, followed by image subtraction

(differencing) have been also presented. This procedure results in an easily interpretable and extremely quick approach to change detection of land cover as well as change in biomass, and it can be used as a "first warning" method to indicate archaeological sites threatened by the nearby changing landscape.

2. REMOTE SENSING

2.1 Introduction

Remote sensing covers all techniques related to the analysis and use of data from environmental and earth resources satellites and from aerial photographs. Remote Sensing is the science of deriving information about an object from measurements made at a distance from the object (i.e. without actually coming in contact with it).

With their continuous development and improvement, and free from national access restrictions, satellite sensors are increasingly replacing surface and airborne data gathering techniques. At any one point in time, day or night, multiple satellites are rapidly scanning and measuring the earth's surface and atmosphere, adding to an ever-expanding range of geographic and geophysical data available to help us manage and solve the problems of our human and physical environments. Remote Sensing is the science of extracting information from such images.

Landsat TM and MSS, SPOT satellite images are widely used for deriving information about the earth's land. Moreover, the operational availability of high-resolution satellite imagery, (i.e. Quickbird, IKONOS), opens up new possibilities for investigating and monitoring natural resources. Compared with traditional survey techniques, satellite remote sensing is

* Corresponding author.

accurate, timely and cost-effective. These data offer a number of advantages:

- Provide synoptic coverage and therefore give an extensive view of vast areas at the same time.
- Images can be acquired for the same area at a high rate of repetition (two to three times a month), thus permitting selection of the most appropriate seasonal data.
- Satellite images are recorded in various wavelengths, visible and non-visible, which provide accurate information on ground conditions.
- They can be obtained for any part of the world without encountering administrative restrictions.

2.2 Fundamentals of Remote Sensing

The Sun has a temperature of about 5800 degrees Kelvin, and emits electromagnetic radiation from about 0.5-4.0 micrometers (Mather, 2001; Richards, 2005). This radiation is filtered by the Earth's atmosphere, which absorbs energy in a series of bands related to the chemistry of the atmosphere. Energy reaching the surface of the earth is reflected - the amount of energy reflected in each wavelength is a function of the surface characteristics, so that in principle different types of surface can be identified from their spectral reflectance characteristics, since these differ significantly from material to material (see Figure 3). Some energy is absorbed by the Earth, which because it has a lower temperature than the Sun is re-emitted at higher wavelengths (typically between thermal infrared wavelength region i.e. 8-12 micrometers with maximum intensity at 10 micrometers). Hotter objects on the Earth's surface emit significantly more radiation at these 'thermal' wavelengths.

Energy leaving the Earth's surface must travel once again through the atmosphere before reaching a satellite sensor. Atmospheric effects can significantly modify the radiation (an obvious effect can be seen when cloud cover is present), by absorbing and attenuating it differentially in the various wavelengths of interest, and by adding to it as a result of energy scattered within the atmosphere and then radiated towards the satellite. Atmospheric effects vary spatially and with time, as a result of changes in atmospheric moisture and pollution.

Satellite remote sensing systems essentially consist of a platform (the satellite) upon which is mounted a camera or a series of cameras. Electromagnetic radiation (visible light and infrared radiation) is filtered as it arrives at the satellite, with different wavelengths being sent to different detectors. Because of the absorption of the atmosphere little energy arrives at certain wavelengths, and so detection is normally restricted to a limited number of bands, which detect energy in the atmospheric 'windows'. Most satellite sensors will detect in a limited number of bands, and many fewer than will be used on an airborne multi-spectral sensor.

The filtered electromagnetic energy is passed to sensors that detect its intensity, and convert it to a digital number (DN). The sensor captures energy for a series of small areas of the ground ('picture elements', or pixels) that it images.

Multi-spectral satellite data consist not of 'images' in the commonly-accepted sense of the term, but a number of matrices, each cell within a given matrix representing the intensity of the electromagnetic energy received in a particular wave band from a given pixel, or small area of the ground.

These data must be manipulated mathematically before an image can be produced, perhaps being projected on a computer screen or printed. A number of stages of processing may be carried out before the results are presented to the end user. These are:

- geometric correction, to align the image with some ground control system (e.g. latitude and longitude, or some national grid reference system)
- atmospheric correction to recover, as far as possible, the reflectance at the ground surface
- processing, either to extract the most from the data (e.g. edge detection to identify boundaries) or to classify pixel values as far as possible in terms of the ground conditions
- Presentation of data, typically involving the assignment of computed data (following stretching) to the three primary CRT colours (red, green, blue) for display purposes, or the assignment of land classes to different colours in order to produce a thematic map.

3. SPECTRAL SIGNATURES

Features on the Earth reflect, absorb, transmit, and emit electromagnetic energy from the sun. Special digital sensors such as spectro-radiometers have been developed to measure all types of electromagnetic energy as it interacts with objects in all of the ways listed above. The ability of sensors to measure these interactions allows us to use remote sensing to measure features and changes on the Earth and in our atmosphere.

A measurement of energy commonly used in remote sensing of the Earth is reflected energy (e.g., visible light, near-infrared, etc.) coming from land and water surfaces or other targets. The amount of energy reflected from these surfaces is usually expressed as a percentage of the amount of energy striking the objects. Reflectance is 100% if all of the light striking and object bounces off and is detected by the sensor. If none of the light returns from the surface, reflectance is said to be 0%. In most cases, the reflectance value of each object for each area of the electromagnetic spectrum is somewhere between these two extremes.

Across any range of wavelengths, the percent reflectance values for landscape features such as water, sand, roads, forests, etc. can be plotted and compared. Such plots are called "spectral response curves" or "spectral signatures." (See Figures 4, 5) Differences among spectral signatures are used to help classify remotely sensed images into classes of landscape features since the spectral signatures of like features have similar shapes.

Knowledge of the spectral characteristics of the materials to be classified when imaging cultural heritage sites is essential if robust image processing techniques are to be identified or developed. Spectral analyses of digital data are normally carried out using one of the following:

- 'standard' analyses, such as the 'tasselled cap' (Crist and Cicone, 1984) or NVDI methods, that produce images processed to enhance certain ground characteristics (e.g. vegetation cover), but must be interpreted subjectively
- Classification techniques that aim to identify ground characteristics.

Classification can be 'unsupervised', dividing the ground cover into a predetermined number of classes on the basis of its spectral characteristics alone, or 'classified', using knowledge of ground cover at various positions on the particular image or images ('ground truth'), or using reflectance data obtained from spectro-radiometers such as those shown in Figures 3, 4 and 5. Both have their place in archaeology.

4. CHANGE DETECTION TECHNIQUES

Change detection has become a major application of remotely sensed data because of repetitive coverage at short intervals and consistent image quality. The basic premise in using remote sensing data for change detection is that changes in land cover result in changes in radiance values and changes in radiance due to land cover change are large with respect to radiance changes caused by other factors such as differences in atmospheric conditions, differences in soil moisture and differences in sun angles. Several change detection techniques applied to satellite digital images along with GIS techniques have been reported in the literature. Some of these include image overlay, image difference, ratioing, principal component analysis (PCA), and post-classification etc. An important component to change detection is radiometric calibration including atmospheric correction.

4.1 Image Overlay

The simplest way to produce a change image is by making a photographic two-colour composite (of a single band) showing the two dates in separate colour overlays. The colours in the resulting image indicate changes in reflectance values between the two dates. Thus, features that are bright (high reflectance) on date 1, but dark (low reflectance) on date 2, will appear in the colour of the first photographic overlay. Features, which are dark on date 1 and bright on date 2, will appear in the colour of the second overlay. Features, which are unchanged between the two dates, will be equally bright in both overlays and hence will appear as the colour sum of the two overlays (Mather, 2001)

4.2 NDVI

Many techniques have been developed to study quantitatively and qualitatively the status of the vegetation from satellite images. To reduce the number of parameters present in multispectral measurements to one unique parameter, the Vegetation Indexes were developed. Vegetation Indexes are combinations of spectral channels, in such a way that it reflects the contribution of vegetation depending on the spectral response of an area, minimizing the contribution of other factors such as soil, lighting, atmosphere, etc. (Richards, 2005). The Normalized Difference Vegetation Index (NDVI) is a nonlinear function which varies between -1 and +1 but is undefined when RED and NIR are zero. Only the positive values correspond with vegetated zones. The negative values, generated by a higher reflectance in the visible region than in the infrared region, are due to clouds, snow, bare soil and rock

4.3 Basics of classification

Objects of similar natures have similar spectral properties. That means that the electromagnetic radiation reflected by objects or targets of the same nature is similar overall and these objects will thus have similar spectral signatures. Since the spectral signatures of the objects observed by satellite sensors are

converted into different colours in digital images, objects of the same kind will appear in closely related colours. This property has been widely used for many years to interpret aerial photographs and the images supplied by Earth-observing satellite sensors. The interpreter places in the same category all the objects in an image that seem to have the same or closely related colour. Based on the fact that the colours in a digital image are merely a conventional transposition of numerical values, it is also possible to exploit the computer's computational power to classify the pixels by their numerical values, which is to say, in the final analysis, by the corresponding objects' spectral properties (Janssen *et al.*, 1990). This is the basic principle of image classification. Basically there are two types of classification, the unsupervised and supervised classification:-

In unsupervised classification, the computer is allowed to analyse all of the spectral signatures of all of the image's pixels and to determine their natural groupings, that is to say, to group the pixels on the basis of their similar spectral signatures (Richards, 2005). The main advantage of this method is its great speed, for it requires practically no intervention from the user.

Supervised Classification is a procedure for identifying spectrally similar areas on an image by identifying 'training' sites of known targets and then extrapolating those spectral signatures to other areas of unknown targets (Richards, 2005). Supervised classification relies on the *a priori* knowledge of the location and identity of land cover types that are in the image. This can be achieved through field work, study of aerial photographs or other independent sources of information.

Remote sensing can be a discovery technique, since the computer can be programmed to look for distinctive "signatures" of energy emitted by a known site or feature in areas where surveys have not been conducted. Such "signatures" serve as recognition features or fingerprints. Such characteristics as elevation, distance from water, distance between sites or cities, corridors, and transportation routes can help to predict the location of potential archeological sites

Since sand, cultivated soil, vegetation, and all kinds of rocks each have distinctive temperatures and emit heat at different rates, sensors can "see" things beyond ordinary vision or cameras. Differences in soil texture are revealed by fractional temperature variations. So it is possible to identify loose soil that had been prehistoric agricultural fields, or was covering buried remains. The Maya causeway was detected through emissions of infrared radiation at a different wavelength from surrounding vegetation. More advanced versions of such multi-spectral scanners (Visible & IR) can detect irrigation ditches filled with sediment because they hold more moisture and thus have a temperature different from other soil. The ground above a buried stone wall, for instance, may be a touch hotter than the surrounding terrain because the stone absorbs more heat. Radar can penetrate darkness, cloud cover, thick jungle canopies, and even the ground.

4.4 Image Differencing

Another procedure is to register simply two images and prepare a temporal difference image by subtracting corresponding pixel values for one date from those of the other. The difference in the areas of no change will be very small, and areas of change will reveal larger positive or negative value. In this method, registered images acquired at different times are subtracted to

produce a residual image, which represents the change between the two dates. Pixels of no radiance change are distributed around the mean, while pixels of radiance change are distributed in the tails of the distribution.

5. METHODS AND MATERIALS

The post-processing techniques for visualise the land-cover changes in the nearby landscape of the archaeological sites have been applied to both Landsat TM and high-resolution images such as Quickbird and IKONOS. Then, based on the acquired in-situ spectro-radiometric measurements, NDVI and classification techniques have been applied to compare directly the % of identification and extraction of the archaeological sites (image extraction Vs in-situ).

5.1 Images

Archived Landsat-5 TM images of the Paphos District area in Cyprus acquired on the 30/01/2001, 11/5/2000, 11/9/98 and 3/6/1985 have been used (Figure 1). Ikonos (Figure 6) and Quickbird image acquired on 14/3/ 2000 and 23/1/2003 respectively was also used to track more easily the spectral targets (Figure 2). The District areas of Paphos and Limassol which consist many cultural heritage sites have been selected to be used as pilot studies.



Figure 1: Quickbird- 0.6m resolution image of Paphos harbour area acquired on 23-12-2003 (castle and House of Dionyssos area)

5.2 Ground Measurements

The Remote Sensing and Geodesy Laboratory of the Department of Civil Eng. and Geomatics at the Cyprus University of Technology support the ground measurements of this project. Indeed, Two GER1500 field spectro-radiometers and the SCV HR-1024 have been used to retrieve the amount of atmospheric effects in different targets in the vicinity of cultural heritage sites (see Figures 2, 3, 4 and 5).



Figure 2: Collection of spectral signature data on a whitish bare soil using the GER1500 Field Spectroradiometer



Figure 3: SCV HR-1024 Field Spectroradiometer

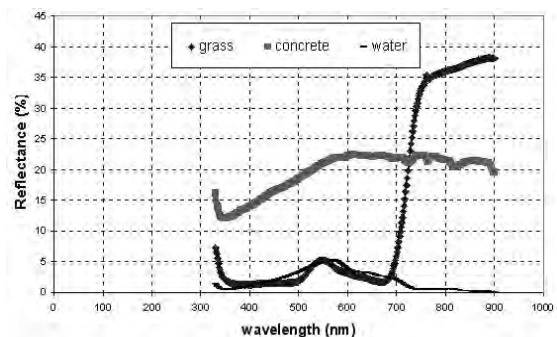

Figure 4: Spectral signatures of three different materials: grass, concrete, water obtained using a GER1500 field spectro-radiometer

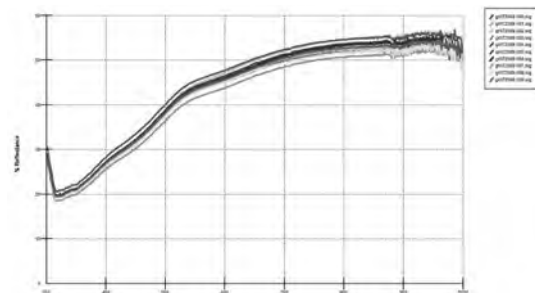

Figure 5: Spectral signatures of bare soil (whitish colour) obtained using a GER1500 field spectro-radiometer on the 20/7/2008 in Paphos District area.



Figure 6: Unsupervised classified-5 classes IKONOS pan-sharpened 1m high-resolution satellite image of Katos Paphos archaeological site acquired on 14th of March 2000.

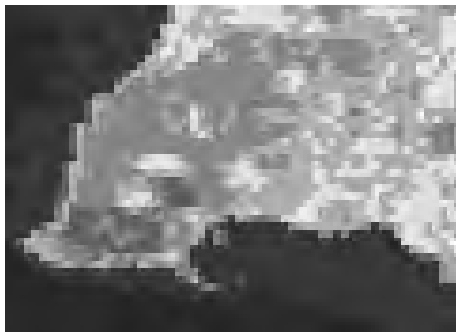

Figure 7: Unsupervised classified (7-classes) Landsat TM image of Katos Paphos archaeological site acquired on June 1985.

5.3 Application of atmospheric correction

The darkest pixel (DP) atmospheric correction method, also termed also histogram minimum method was applied to the multi-series satellite images of Cyprus area since it has been found that is the most effective atmospheric correction algorithm (Hadjimitsis *et al.*, 2003).

5.4 Extraction

Further to the application of the change detection algorithms, the processing was carried out using Principle Component Analysis (PCA) (see Figure 8), Tasseled Cap Transformation (TCT), Decorrelation Stretch (DS) and RGB colour composites (Mather, 2001) for site extraction.



Figure 8: Principal Component Analysis: Quickbird- 0.6m resolution image of Kato Paphos Paphos archaeological area acquired on 23-12-2003

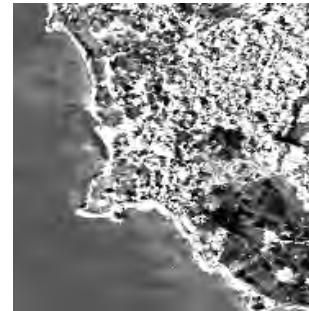

Figure 9: Image-Subtraction of Landsat TM images: 2000-1985

6. RESULTS

On completion of the image processing as expected the best results come from transformations in which the near infrared band plays a primary role, especially in NDVI, Principal Component Analysis, brightness and Wetness Transformation and relative colour composites. In our study we concluded that bands green, red and near infrared, show the most potential for the identification of archaeological features. Red and near infrared images are less affected by haze and provide good definition for soil marks and crop marks. Despite these promising early results the true potential of this type of imagery is still not fully clear and needs to be further evaluated to test its responsiveness under a broad range of environmental conditions.

By applying the change detection techniques, it has been found that in the nearby area of the Kato Paphos archaeological site area, a 20 % difference in the landscape has been occurred (Figure 9). Indeed by comparing the results obtained between supervised and unsupervised classification results for the high-resolution satellite images based on the use of the in-situ spectral signatures, it has been found that in the green and red bands the difference between the two methods on the % measured land in each class was 10 %.

7. CONCLUSIONS

It has been shown that the integration of both post-processing techniques with the in-situ spectroradiometric measurements can improve the effectiveness of such methods especially for monitoring landscape changes in the vicinity of archeological sites. We concluded that bands green, red and near infrared, show the most potential for the identification of archaeological features. By applying the change detection techniques, it has been found that in the nearby area of the Kato Paphos archaeological site area, a 20 % difference in the landscape has been occurred. Future work consists of further validation and assessment of every post-processing algorithm for such task in conjunction with simultaneous measurements of the following: image overpass, spectral signature measurement and atmospheric conditions measurements.

8. REFERENCES

- Barnes I., 2003. Aerial remote-sensing techniques used in the management of archaeological monuments on the British Army's Salisbury Plain training area, Wiltshire, UK, *Archaeological Prospection* 10:83-90.
- Campana S., 2007. Ikonos-2 multispectral satellite imagery to the study of archaeological landscapes: An integrated multi-sensor approach in combination with "traditional" methods, http://www.lapetlab.it/testi/Ikonos_2.pdf.
- Cavalli R., Colosi F., Palombo A., Pignatti S. and Maurizio Poscolieri. 2007. Remote hyperspectral imagery as a support to archaeological prospection. *Journal of Cultural Heritage* Volume 8, Issue 3, p. 272-283.
- Crevaschi M. and Forte M., 1999. Reconstructing a fossil landscape by Remote Sensing and GIS applications: sites, virtual models and territory during the Middle Bronze Age in the Po Plain (Northern Italy). In *Archeologia e Calcolatori*, 9, pp. 207-227.
- Crist, E.P., and Cicone, R.C., 1984, Application of the Tasseled Cup Concept to Simulated Thematic Mapper Data. In *Photogrammetric Engineering and Remote Sensing*, vol.52, no.3, pp.343-352.
- Fowler Martin, J.F. 2002. Satellite remote sensing and archaeology: a comparative study of satellite imagery of the environs of Figsbury Ring, Wiltshire, and Archaeological Prospection 9:55-69.
- Hadjimitsis D.G., Clayton C.R.I., and Retalis A., 2003. Darkest pixel atmospheric correction algorithm: a revised procedure for environmental applications of satellite remotely sensed imagery, *Proceedings 10th International Symposium on Remote Sensing*, 8-12/9/2003, Barcelona -SPAIN, organised by NASA, SPIE CONFERENCE, and p.414.
- Hadjimitsis D.G., Themistokleous K. and Lazakidou A., 2007. Utilizing Geographical Information (GIS) and Satellite Remote Sensing Analysis for Integrated Planning: A Case Study of Paphos District Area - UNESCO World Heritage Town (Paphos, Cyprus), *The 21st CIPA International Symposium, Athens (Greece), 1-6 October 2007*, p.362-365 ISSN:1682-1750.
- Hadjimitsis, D.G, Themistocleous K. and Ioannides M., 2005. The use of Satellite Remote Sensing for the management of cultural heritage sites in Cyprus, *XX Symposium of CIPA, the ICOMOS & ISPRS Committee on Documentation of Cultural Heritage*, Torino-Italy, September 2005 (2005), p.356.
- Hadjimitsis, D.G, Themistocleous K., Ioannides M. and Clayton C., 2006. The registration and monitoring of cultural heritage sites in the Cyprus landscape using GIS and satellite remote sensing', *37th CIPA International Workshop on e-Documentation and Standardization in Cultural Heritage, Symposium of CIPA, the ICOMOS & ISPRS Committee on Documentation of Cultural Heritage*, Nicosia-Cyprus, Nov. 2006.
- Janssen, Lucas F. with Marijke N. Jaarsma and Erik T. M. van der Linden, 1990, *Integration Topographic Data with Remote Sensing for Land-Cover Classification. Photogrammetric Engineering and Remote Sensing*, Vol 56, No. 11, pp 1503-1506.
- Lasaponara, R. and Masini, N., 2005. QuickBird-based analysis for the spatial characterization of archaeological sites: case study of the Monte Serico Medioeval village. *Geophysical Research Letter*, 32(12), L12313 10.1029/2005GL022445.
- Mather, P., 2001. *Computer Processing of Remotely sensed Images*. John Wiley, UK.
- Miller F. and Lee D., 1991, Applications of Ecological Concepts and Remote Sensing Technologies in Archaeological Site Reconnaissance," (In *Applications of Space-Age Technology in Anthropology*, edited by Clifford Behrens and Thomas Sever. NASA, Stennis Space Center, MS.
- Pavlidis L., C., Fraser C.S. and Ogleby C., 2001. The application of High-resolution satellite imagery for the detection of ancient Minoan features on Crete. In Burenhult G. (eds.), *Archaeological Informatics: Pushing the Envelope CAA 2001, proceedings of the 29th Conference*, Gotland, April 2001, pp.393-400, (BAR International Series, 1016).
- Pieri M. and Pranzini E., 1989. Geomorphological evolution of the Pisa plain in historic time deduced from Landsat TM data. In *Global Natural Resource Monitoring and Assessment: Preparing for the 21st Century*, proceedings, Venezia, November 1989, pp. 1385-1388.
- Richards J.A., 2005, *Remote Sensing Digital Image Analysis: An introduction*, Springer-Verlag, Berlin.

9. ACKNOWLEDGEMENTS

The authors acknowledge the support of the Remote Sensing Laboratory and Geodesy Laboratory of the Department of Civil Engineering and Geomatics at the Cyprus University of Technology for providing the GER1500 and SVC HR-1024 field spectro-radiometers (<http://www.cut.ac.cy/ce/>)

Cultural Heritage Resource Information Systems

TURNING THE PAGES 2.0: DEVELOPING A BROWSER-BASED APPLICATION FOR HIGH-RESOLUTION 3D MODELLING OF BOOKS, MAPS AND 3D ARTEFACTS

Michael Stocking.

CEO, Armadillo New Media Communications Ltd, michael@armadillosystems.com

KEY WORDS: Manuscripts, 3D, XAML, Windows Presentation Foundation, British Library, Turning the Pages

ABSTRACT:

Turning the Pages is a software application developed in conjunction with the British Library to provide both online and offline access to its special collections via touch screen kiosks and a standard web browser. It is designed to be highly intuitive, provide great ease of use for a broad audience, provide a small set of useful scholarly tools, and be able to scale easily to many hundreds or thousands of volumes. The development was carried out with the assistance of Microsoft UK and utilised several of their core 3D technologies. Subsequent development has moved the application from being suitable only for books from the British Library to allow it to be used by libraries around the world and also to include very high resolution maps and other 2D objects as well as embed complex 3D artefacts. This paper is a case study which outlines the technical aspects of the project, problems overcome, problems remaining and future challenges.

1. THE PROBLEM OF ACCESS TO RARE BOOKS

1.1 The British Library Experience

Among their collection of 150 million items, the British Library holds a large collection of rare or important books and manuscripts including the Magna Carta, the Lindisfarne Gospels, Shakespeare's First Folio, and the Diamond Sutra, the earliest dated printed item in the world.

Many of these are kept in the Treasures Gallery in the British Library in London in secure cases (Figure 1):

However impressive the cases, the members of the public, the curators, the educators, and those who work in interpretation and exhibitions are left with a number of basic problems:

- Only a limited number of books can be displayed at any given time
- Only two pages from each book can be seen
- Scope for interpretation is very limited
- Scope for collaboration is nil
- Visitors have to come to London to see the books



Figure 1: The British Library's "Sacred" exhibition

Turning the Pages was developed as a software approach to viewing books. Early versions had been developed using Adobe Director (Figure 2). One version worked on a cell-animation approach, modeling an entire book in 3D (using Newtek Lightwave), and then outputting and animating the individual cells, and the other had introduced a "fake" 3D which allowed it to run as Shockwave applications in a browser.

Both iterations suffered from the same problem – they were custom applications, and each book had to be individually built at considerable time and expense.



Figure 2: Turning the Pages Shockwave version

1.2 Scoping a solution

The solution to the problem would be to develop a new version of Turning the Pages, built on the latest research and using the latest tools.

The core ambitions were:

- To make an application that would offer a more compelling, truly three-dimensional experience of a book

- To build in a toolset that would allow the application to be meaningfully used by academic researchers
- To allow the application to scale easily to many hundreds or thousands of volumes (Kelly K, 2006)

It would be an application that would run on 2007 specification hardware, but essentially be built for the next 5-6 years. These ambitions presaged the emerging digital library and encompassed the increasing importance of providing access and interpretation to core material to broad audiences (Wilkinson H, 2005).

2. BUILDING A SOLUTION

2.1 Building a partnership

Very early on, both Microsoft UK and Microsoft Corporation expressed an interest in helping with the project. A project team then formed involving Microsoft, the British Library (BL) and Armadillo New Media Communications (Armadillo), and a deadline was set for launch of the software for February 2007 – the launch of Windows Vista.

2.2 Starting with users

Both the BL and Armadillo had extensive experience of developing applications to provide access and interpretation to collection for members of the public. This experience informed the look and feel of the application as well as the functionality.

A number of user scenarios were mapped out:

- A schoolchild, working remotely who wanted to research a topic and message with their peers around a subject area
- A visitor to the BL who wanted to spend a few minutes briefly exploring a manuscript, but who had no special interest or knowledge of that manuscript
- A researcher with specialist knowledge who wanted to study a book from home in detail over a period of time and collaborate with colleagues.

These scenarios allowed us to build a desired toolset:

- Page turn (dragging)
- Page turn (click to turn)
- Navigation to any page
- Search
- Page rotation
- Page zooming
- Magnification
- Book move
- Commentary text
- Commentary audio
- Note-taking
- Help

This toolset was felt to offer the users a minimal set of tools that would meet their needs but be usable in the future (Thompson, Debora Viana; Hamilton Rebecca W. ; Rust, Roland T. , 2005). The critical issue would be to avoid building a visually impressive 3D book that was not useful.

2.3 Choosing a development platform

As one of the overarching ambitions was to develop a compelling 3D interface, we evaluated a number of 3D environments (with a view to having to meet our other ambitions also). These included open-source and paid-for game engines, Adobe Shockwave 3D, Adobe Flash/Papervision, Java OpenGL, X3D and XAML/Windows Presentation Foundation.

Some of these platforms were not felt to be mature enough to deliver a robust consumer experience in the development timeframe, and some offered very limited 3D functionality (ie control of lights, polygon counts etc). XAML, running in the Windows Presentation Foundation, offered the promise of true realtime 3D in a browser or as an executable, with extensive re-use of code for a Macintosh and Linux solution and was therefore the chosen platform.

The development environment was therefore Visual Studio, Expression Blend, C# and XAML, with the initial desired outputs being a XAML Browser Application (xbap) and an executable.

As we had committed to the Windows Presentation Foundation, we could adopt HD Photo as a file format for bitmap textures. This allows for file sizes comparable to JPEG 2000 (ie 50% of JPEG at equivalent quality), has no licensing implications and was going through ISO approval as JPEG XR. File size was critical to the project as we wanted to load in up to 1000 bitmap textures for each book.

2.4 Generating 3D models in XAML

Armadillo already had some experience of developing 3D books in Lightwave from previous projects and had a number of page and book models built to millimetre accuracy, with page turn shapes derived from video footage of curators turning the pages of the chosen books

There was no production path from Lightwave to XAML at that point however, and XAML, as an emerging platform, was not well supported by third party tools.

As a result Armadillo had to develop a convertor that would convert from Lightwave to XAML, including texture support, specular data, morph data and animation.

Armadillo were indebted to the work done by Mark Hennessy-Barrett and Alex Young in this area who wrote a convertor that supported all the features we needed.

The Lightwave models were sampled at various polygon counts and it was determined that a count of 1500 per page surface would offer a realistic page impression when the page was turning, without incurring too high a CPU overhead in processing the turn.

Each page turn had to deform as it turned hitting a set of 8 morph targets during the turn. This generated a realistic turn (Figure 3) where a page changes from flat to several stages of deformation as it progresses through the turn to resting flat again. One thing observed was that a page shape will change as the page approached the vertical, which is the point of maximum load though the Z axis. Most pages will tend to collapse on themselves at that point, producing recognisable “S” shapes.

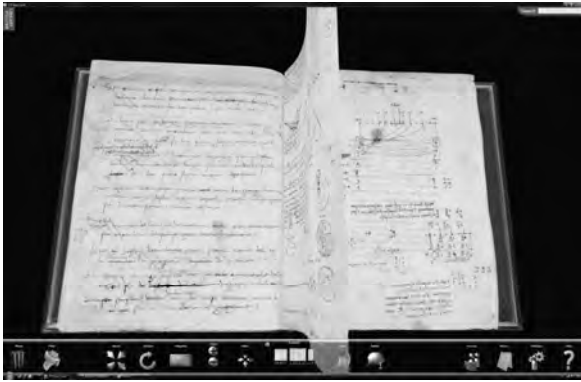

Figure 3: developing a realistic page turn

There were then developed a set of 6 vellum pages shapes derived from the video footage of vellum turning, and 6 paper page shapes from footage of paper turning. The paper turns exhibited a more pronounced collapse as they come under load and as they fall at the end of a turn.

The application would then be able to determine whether a book was paper or vellum and then apply the appropriate 3D models, randomly picking one of the six turn shapes each time.

Modelling the spine and binding structure was simpler, with simple pivots introduced at both planes where the spine met the binding.

The book model was completed by the pages being attached to the inside of the spine in a code-defined manner (evenly spaced, front or back aligned), which then allowed the shear of the pages to be evident when a bound volume was opened.

Specularity mapping was introduced as a separate texture to allow for the realistic portrayal of gilding (Figure 4), and, once identified, we could apply specular highlights with control over the colour and shininess of the gilding. In a true 3D environment we would also then be able to emphasise these aspects by control of lighting.



Figure 4: Specular highlights in the “Sherborne Missal”

2.5 Coding interactivity and optimisation

From the generated XAML there then remained the task of integrating the models into the application, coding the interactivity and toolset as well as optimisation.

The fundamental construct of the application is that it uses a content-agnostic wireframe model, and maps textures to it in real time. We used MS SQL Server to contain the textures and metadata (structured according to Dublin Core standards), and then wrote a control that allowed the user to interact with the book in a realistic way. The control was then embedded inside the application in a modular way, with a view that we may want to embed different (non-book) items inside the application in the future.

The page turn code was written in such a way as to allow easy turning of the page and for the page to have gravity – once past the vertical, it would fall to rest in a natural fashion.

Inside the 3D viewport a number of manipulations of the book are allowed to occur. The first is the ability to move the book in the X and Y axes. By invoking the “Move” tool (or holding down the Control key) the user can move the book in both axes. Positioning the book on screen in this way was felt to be useful when text panels are also visible in the workspace.

The zoom tool allows users to make the book larger or smaller in the viewport. This is essential for comfortable viewing of the volume as well as scrutinising any small details. The texture size of 1200 pixels (Y axis) was determined as a realistic size allowing for fast downloads, minimal stress on the GPU and enough detail to make reasonably close examination of the page possible. The application was tested with texture sizes up to 4000 pixels Y axis, but it was found that even on dual core PCs with 512Mb VRAM, 4GB RAM, performance was sluggish.

For the the Move and Zoom tools, the book is not moving, just the camera position.

The third tool is the pivot tool, which is not exposed via the toolbar. By holding down the Shift key, users can pivot the book around it’s centre point, allowing, in combination with the other tools, completion freedom of movement in the X, Y and Z axes.

For very large books a way was needed to reduce polygon count as well as texture maps in use. One of the launch volumes was to be Leonardo da Vinci’s Codex Arundel, a book of 564 pages. Even with the optimised polygon count model, there would be in the region of 846,000 polygons in the scene, as well as 112Mb of textures (HD Photo files were used with a vertical resolution of 1200 pixels, giving an average file size of 200k at 96 dpi).

The model developed was to have a set of pages “in play”. These comprised the pages on view, their reverse faces as well as the facing pages. These pages would utilise the high-resolution (200k) textures and the high polygon count (1500) models. The remainder of the pages in the book would be downsampled to very low polygon count models (5 polygons) and very low resolution textures (15k). As a page turned the models and textures would be swapped out to the high resolution ones as needed, disposing of the now unused high resolution versions. This had the added benefit of users with slower connections only briefly seeing lower resolution

versions of pages which rapidly resolved to high resolution ones, rather than them being faced with a blank page.

Memory management was still an issue with the Codex Arundel however. With 564 pages memory utilisation would be very high, requiring 2Gb of RAM in the client PC. For launch we therefore reduced the page count to the first 100 pages, but in a subsequent revision we re-coded the page loading to dynamically load only a specified number of pages (normally around 50-70). If a book was under that number of pages, all the pages would be loaded, if it was above that number, the first 50 pages would be loaded, but as the user progressed through the book, pages would be shuffled in and out of the 50 pages “in book” as they were needed. This had the effect of dramatically reducing the memory requirements and effectively reduced the GPU requirement from 128Mb dedicated card to a 64Mb dedicated card or the ability to run well on integrated graphics such as the Intel GMA X3100.

CPU load was much less of an issue, with the processor loads being very low. Windows Presentation Foundation also offloads much of the computational work to the GPU, so the main area in which slow performance was experienced was in the case of very low-end GPUs.

Turning the Pages was also developed to allow the user to have multiple books in the virtual workspace, and it was found that up to 7 books could be in the workspace at any time before memory requirements became a problem.

2.6 Testing and real-world performance

Testing was carried out in three ways: application performance on client PCs; usability testing using focus groups; server load testing.

3D performance on the development PCs was flawless, even when running with oversized bitmaps. Shortcomings in performance were normally exhibited when the page turned as this was more computationally-intensive than (for example) pivoting or moving the book.

Testing on lower specification PCs, a Pentium 4 3.2 GHz with an ATI Radeon 9600 128Mb card exhibited some slowdown of the page-turn, but otherwise performed well. This was a 2003-era PC.

PCs with integrated graphics fared less well, particularly those on laptops with low amounts of memory. The integrated Intel GMA950 graphics chipset offered such a slow framerate that the application became unusable, particularly on older PCs running Windows XP with 512Mb RAM.

The memory issue also came to the fore when testing against Windows Vista installed on both newer and older PCs. On older PCs it was found that performance became sluggish with even 1Gb RAM, and barely usable with 512Mb.

Testing revealed a variety of different GPU/CPU/RAM combinations that would offer good performance, but we settled on adopting Windows Vista Premium Ready standards from Microsoft as a baseline to avoid confusion:

- 1 GHz 32-bit or 64-bit processor.
- 1 GB of system memory.
- Support for DirectX 9 graphics, 128 MB of graphics memory
- 40 GB of hard drive capacity.

One area where there was little control was over drivers. The installation of the most recent video drivers from Intel, ATI or Nvidia was critical to the 3D performance, especially under Windows Vista. Poor performance on ostensibly high-performance PCs was almost always down to older drivers.

Usability testing was carried out in two stages: at the prototype stage and after amends, pre-launch. In both cases it was carried out using three members of the public using the application with a facilitator, being observed by developers and the client (BL) from behind two-way mirrors, with the session screen-recorded and audio recorded. This was done with the Web Usability Partnership.

Users feedback was summarized as follows:

“Overall, testers reacted extremely positively to the new Turning the Pages prototype. They felt that it was incredible to be able to examine literary treasures (in such high quality) in this way. It was not immediately obvious to all testers how to use ‘Turning the Pages’ (i.e. how to turn the pages of the books), but once they realised how it worked they thought that it was a very valuable and interesting facility.

All testers said they would use ‘Turning the Pages’ again and they would recommend it (mostly to friends). The overall ‘ease of use’ ratings of the site indicate that the most recent version of the prototype is easier to use than the earlier version (NB different users were used to test the prototype for each round).”

The final aspect of testing was to see, from a technical viewpoint, how the application would perform under severe load, and what the server requirements would be.

A simulated server infrastructure was built at Microsoft’s UK lab, and we coded the application to automatically request books. Many hundreds of instances of the application were then instantiated and we tested the load on the server infrastructure.

The key finding was that as most of the computation was being done client-side, the server CPUs were scarcely loaded, and the RAM requirements were unexceptional. What was being stressed were the network ports as the servers had to serve out many 200k files per second, per application running.

This led to specifying a final server infrastructure comprising 22 quad core servers, 2 load balancers and a separate disk storage unit. Bandwidth was set to be scaled to 2Gbits/sec.

We specified this level of infrastructure as, during the course of the project it transpired that Bill Gates planned to launch Windows Vista worldwide from the British Library, using Turning the Pages as a showcase of what Windows Vista could do, and what next-generation Rich Internet Applications could look like. The attendant publicity would be likely to generate huge traffic.

2.7 Launch

TTP 2.0 was launched in February 2007 with Leonardo da Vinci's Codex Arundel (owned by the BL) re-united with his Codex Leicester (owned by Bill Gates) for the first time in almost 500 years (Figure 5).

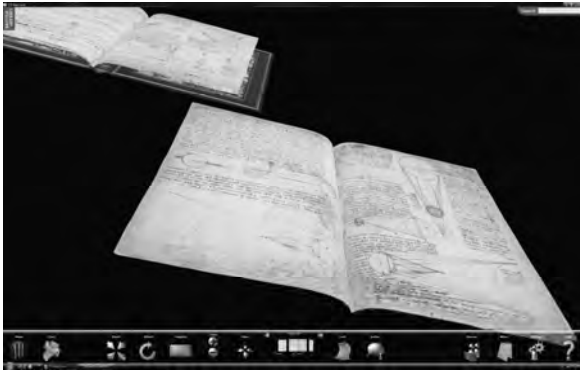

Figure 5: "Codex Arundel" and "Codex Leicester" reunited

The server infrastructure coped with the level of traffic that we experienced and the application was well-received by those who saw it.

The application subsequently won the British Computer Society 2007 award for Best Web Technology.

3. FUTURE DEVELOPMENTS

Having completed the first version, attention was turned to two allied areas of interest: how to depict very high resolution images (particularly maps) in a browser in a 3D environment; and how to display 3D artefact in the same space. The goal was to develop a unified 3D display environment, where a book could co-exist with a map, painting or charter, as well as an artefact such as a microscope or sculpture.

The 3D artefacts were tackled first, and using the Lightwave to XAML convertor, a high resolution 3D model of an astrolabe (Figure 6) was integrated into the TTP 2.0 space:



Figure 6: 16th Century astrolabe, demonstrating specularity

This model was originally built in 3d Studio, with textures captured from high-resolution digital photography. Raw data from laser-scanning was used first, but there was trouble

downsampling a 4 million point cloud data set. The work in this area is ongoing and there is a project in place to integrate a number of 3D objects, with capture techniques including photogrammetry and laser scanning. From a common file format like .3ds or .dxf there is now a clear pathway to XAML and therefore into TTP 2.0. The database has also now been coded to accept these objects and their different characteristics.

Maps became a particular problem in a browser. Large-scale maps captured at high-enough resolution to be meaningful ended up with very large file sizes (300-800mb as TIFFs). Even using HD Photo the file sizes were too large to incorporate in a browser-based application (for both download and memory-utilisation reasons).



Figure 7: 300Mb map of Ireland in 3D

For that reason some software code-named SteveDragon has been developed (Figure 7), inspired by Microsoft software called Seadragon, but developed at Armadillo by Steve Kennett.

It tiles an image and produces multiple surrogates in a completely flexible way and imports them into the TTP workspace.

The end result is a smooth and seamless experience of zooming into the smallest detail on a very large bitmap, all in 3D in a browser. The first implementation of this has been at the National Archives in London.

Additionally a content management system has been developed to allow non-technical staff to add books to their online or offline library and a cross-platform version of TTP 2.0 without true 3D has been developed to run on the Macintosh and Linux platforms, using Silverlight.

4. CONCLUSIONS

Both ourselves and the BL regard the ambitions as being largely met, a conclusion endorsed by the British Computer Society award.

The application certainly demonstrates an outstanding user experience, with many Microsoft staff still using it to demonstrate "the art of the possible". It has been shown to many libraries and institutions around the world as well as heads of state, and has received popular acclaim.

The toolset developed has been mostly successful. The note-taking facility has been very rarely used. That can be attributed

to the fact that many of the users to date have been fascinated by the technology or the books, but not been using the application as a study aid.

Search has only recently been integrated, so it's success has been hard to measure, but that will depend on the quality of the metadata underlying the book.

The ability to rapidly scale has been an undeniable success. If a client wants a book developed, it can be online within 30-40 minutes from final assets supplied. A library of 17 books for the BL was put online in an hour.

There is also consideration being given to developing an API that would allow TTP 2.0 to integrate directly with an institutions Digital Asset Management database, to allow for seamless publishing of books.

Committing to the Microsoft platform, with particular dependencies on Windows Vista and/or Windows XP with .NET 3.0 was the key decision of the whole project.

There is a strong drive to open-source in the academic communities, but, in the "features vs reach" battle to meet the objectives of developing something both compelling and robust in true 3D, there was not an open-source alternative.

This caused some anxiety about potential uptake, but the reponse from clients has been such that their misgivings about vendor-dependency have been outweighed by the quality of the experience.

That being said, the adoption of the application has undoubtedly been hampered by the relatively slow adoption of Windows Vista and the reluctance of organisations (not individuals) to run the Windows update to install .NET 3.0.

The decision to develop a "lite" version of the application in Silverlight to run on Windows 2000, Macintosh and Linux has been important in giving reach, at the expense of features, but the port was relatively straightforward with an increasing amount of code shared between Silverlight and the Windows Presentation Foundation version.

Although developed in 2007, it was always the goal to produce an application that would be viable over the next 5 years. The usefulness of the application will only increase as Windows Vista and then Windows 7 increase their reach to the desktop and the capabilities of the cross-platform Silverlight version increase.

5. REFERENCES

References from Journals:

Thompson, Debora Viana ; HAMILTON Rebecca W. ; Rust, Roland T. , 2005 Feature fatigue : When product capabilities become too much of a good thing *Journal of marketing research*, pp. 431-442

References from Other Literature:

Commission Staff Working Document, Annex to the Communication from the Commission "i2010: Digital Libraries", 30.09.2005

Kelly K, 2006, Scan This Book, *New York Times*, New York,

USA

<http://www.nytimes.com/2006/05/14/magazine/14publishing.html?pagewanted=print>

Wilkinson H, Collections for the Future, Museums Association, 2005

<http://www.museumsassociation.org/collectionsforthefuture>

References from websites:

<http://www.bl.uk/ttp2/ttp2.html>

<http://www.turningthepages.com>

<http://www.ariadne.ac.uk>

<http://hangingtogether.org/>

<http://diglib.org/>

6. ACKNOWLEDGEMENTS

From the British Library the project is deeply indebted to the work of Clive IZARD, Head of Creative Services, and Adrian Arthur, Head of Web Services.

At Microsoft UK the work of Geoff Hughes, Will Coleman and Richard Godfrey was critical, and at Microsoft Corp, Tim Sneath.

Working alongside Armadillo, Alex Young and Mark Hennessy-Barrett contributed vital work in the area of Lightwave to XAML conversion (<http://www.shaxam.com>).

Internally Martha Bramley, Steve Kennett and Jag Rooprai were responsible for designing and building the application.

Assistance for the project was received from Microsoft UK, Microsoft Corp, Dell UK, F5 and Pipex.

Inspiration for the user experience and the role of an application was drawn from all quarters, but presentations at Museum Computer Network and Museums on the Web conferences as well as the Digital Libraries Federation assisted in clarifying thinking.

The astrolabe data was supplied courtesy of the British Museum.

The map integration into TTP 2.0 was for The National Archives, using their assets.

THE HISTORY OF COMMANDARIA: DIGITAL JOURNEYS BACK TO TIME

K. Papadopoulos^a, N. Tsapatsoulis^b, A. Lanitis^c, A. Kounoudes^d

^a Cyprus University of Technology, P.O. Box 50329, 3036, Lemesos, Cyprus,
kyripap@cytanet.com.cy

^b Dept. of Communication and Internet Studies, Cyprus University of Technology, P.O. Box 50329, 3036, Cyprus,
nicolas.tsapatsoulis@cut.ac.cy

^c Dept. of Multimedia and Graphic Arts, Cyprus University of Technology, P.O. Box 50329, 3036, Cyprus,
andreas.lanitis@cut.ac.cy

^d SignalGeneriX Ltd, P.O. Box 51341, 3504, Lemesos, Cyprus,
tasos@signalgenerix.com

KEY WORDS: Interactive Environments, Tools for Education, Documentation and Training in CH, Semantic Processing in CH.

ABSTRACT:

Commandaria is considered one of the oldest types of wines and it has been ranked as one of the best wines of the last millennium. Production of Commandaria in Cyprus is associated with historical and political events that took place at the island, especially during the last millennium, hence studies related to Commandaria are heavily related to the culture and history of Cyprus. Unfortunately up to now the issue of preserving the history and traditions related to the production of Commandaria over the years did not receive adequate attention and as result the danger of losing important aspects of the relevant Cypriot cultural heritage is obvious. With our work we aim to develop an interactive system through which the history of the production of Commandaria at different areas in Cyprus and different time periods will be presented along with historical events that took place in the island and can be related with Commandaria production. As part of the project we will establish a multimedia digital library that will contain items related to the history and production of Commandaria in Cyprus. All multimedia database entries will be sorted according to various criteria, including the chronological period, the geographical location they refer to and the actual contents of the item, and could be searched via semantic-based queries with the aid of an ontology. In addition, an interactive application will be created where users will have the opportunity to explore the history of Commandaria in Cyprus at different geographical locations and different time periods. The final system will operate both as a web application and as a stand alone application in information kiosks. The system we plan to develop will be most useful for preserving traditions related to the production of Commandaria and support efforts of researchers who wish to explore the history of Commandaria and Cypriot culture as well as the great public for educational and entertainment purposes.

1. INTRODUCTION

Commandaria is a sweet liqueur wine, which is manufactured exclusively in Cyprus with the same basic technology, as it was manufactured in Cyprus during the Homeric years. The Commandaria is considered one of the oldest types of wines and it has been ranked as one of the best wines of the last millennium. Traditionally Commandaria in Cyprus was produced in a geographical area that contains 14 villages – the so-called Commandaria region (see Figure 1). Simultaneously, in the course of this wine through the centuries that keeps pace with the history of Cypriot population a big number of heirlooms exists, related to Cyprus wine or even directly to Commandaria, scattered in all over the island and specifically in the region of Commandaria. Ancient amphora, cylices, earthen jars of small and of enormous dimensions, wall paintings, mosaics, poems, books. An enormous cultural, historical and archaeological wealth, that needs to be utilized and exploited for the befalling generations. Commandaria production had caused important socioeconomic influences in the life of people of Commandaria region across the years. We strongly believe that through our research such influence factors will be revealed and made available to researchers of Cyprus history and sociology.

In this paper we describe our preliminary work and plans for future work that will be undertaken in the framework of

Commandaria project, in relation with the development of an interactive system through which the history of the production of Commandaria at different areas in Cyprus and different time periods will be presented. Our work in this area is divided into the data collection, data digitization and annotation, and system design and implementation phases.



Figure 1: The Commandaria Region in Cyprus

During the data collection phase we plan to locate different types of items such as documents, photographs, videos, sound recording and artefacts. Our aim is to collect appropriate items that can be used for synthesizing a complete picture related to the production of Commandaria during a specific time period. An important task to be completed during the data collection process is the scientific evaluation of the items so that the most appropriate items will be used in the system. All items collected will be digitized, pre-processed and annotated using appropriate techniques.

A properly defined ontology along with a multimedia repository will be created so that all items will be stored in such a way that efficient retrieval of information, even in semantic-based terms, and addition of new data is supported. An interactive multimedia system will be designed so that users will be able to retrieve and study information related to Commandaria. The system will be implemented both as a web-based application and stand alone application suitable for use in information kiosks. Special emphasis will be given to the design of the system interface so that the needs and requirements of different categories of users are satisfied.

In the remainder of the paper we provide a brief history of Commandaria, and its relation to the Cyprus history, and describe related work that appeared in the literature. In sections 4 and 5 we describe the data collection and data digitization processes and in section 6 we present our preliminary work on the design of the system. In section 7 we provide concluding comments and plans for future work.

2. HISTORY OF COMMANDARIA

Commandaria is a Controlled Appellation of Origin sweet liqueur wine, which is manufactured exclusively in Cyprus. It is produced from the two indigenous varieties of grapes, Mavro and Xynisteri, by drying of grapes under the sun and fortification of the fermenting juice with wine alcohol, thus sugar, contained in the final wine, is totally natural. Commandaria wine is aged in oak barrels, for a minimum of three years.

As early as 1100 B.C. the great epic poet Homer refers to the wine of Cyprus, indicating that it must have existed long before. The great poet of antiquity Hesiod in his book "Works and Days" written around 800 B.C. describes its production in such detail that there can be no doubt that he had in mind the sweet wine of Cyprus. Furthermore, it is known that the Pharaohs had a preference for Cyprus wine, as did Cleopatra. King Solomon in his famous "Song of Songs" mentions the island frequently, her grapes and her wine.

Traditional Cyprus wine production also continues during the Byzantine and Roman periods, with the latter taking up the baton where the Greeks left off and introducing viticulture to all the countries they conquered. During this period Cyprus wine enjoyed an even greater development, and its trade was carried out on a sounder basis. The Romans took up the technique of wine-making more methodically, writing manuals and guides on wine.

However, the modern history of Commandaria begins after 1192 A.D., when on his way to free Jerusalem from the Arabs, Richard the Lionheart decided to conquer Cyprus first, given that it was an important staging post for the success of the campaign; at the same time, the King of Cyprus, Isaac Comnenos, was hostile to the crusaders. It was then, during his sojourn in Cyprus during the course of the Third Crusade, that Richard the Lionheart married Berengaria, the nuptials taking place on 12 May 1191. Throughout the marriage celebrations the sweet wine of Cyprus was served to the exclusion of all others, without yet having taken on the name of Commandaria. After defeating the King of Cyprus Isaac Comnenos, Richard departed from Cyprus loaded with plunder, selling the island to the Knights Templar and then to the Frank, Guy de Lusignan,

the deposed "King of Jerusalem", who became the founder of a dynasty that was to rule Cyprus for three centuries (1192-1489). Throughout the rule of the Lusignans, settlers that were mainly catholic crusaders in origin established themselves on the island, and were given privileges and land in order to build up the feudal kingdom. Among these were the Knights Hospitallers, the religious and military order of St. John of Jerusalem founded at the end of the 6th century by Pope Gregory. The forty villages situated in the lands given to them formed the feudal territory of the Grand Commandery of Cyprus, whose seat was the castle to be found west of Limassol, known today as "Koulas, or Colossi Castle" (see Figure 3(e)).

Under their government, and in order for them to have better control of the whole of Cyprus, the island was divided into various districts called 'commanderies'. The largest territory was that of Limassol, its centre of administration being Colossi Castle. This area was named 'La Grande Commanderie', to distinguish it from the other two smaller territories: that of Paphos called 'Phoenix', and that of Kyrenia called 'Templos'. Because the Knights of St. John of the Great Commandery loved the wine of Cyprus produced in this area, and further stepped up its production, it was called 'Commandaria'.

After the 12th century, there followed a period when Commandaria was sold in almost all countries of Europe, with Venice as the main importer.

During the course of Turkish rule, the development of viticulture and the production of Commandaria had to a great extent declined due to poverty, oppression and the heavy tax on the wine trade imposed by the Ottoman Empire. Commandaria, however, had by now taken root on Cyprus soil and had been preserved both through tradition and the Christian faith. Already, since Byzantine times, the sweet wine of Cyprus had been designated as the wine of holy communion; thus, despite adverse conditions it survived and was preserved up to the period of British rule, when the first attempts were made to establish the territory of Commandaria and the villages that were entitled to produce this wine, since both its price was far higher than similar wines produced in other areas and the quality of grapes, in terms of natural sugar content, was appropriate for its production.

The systematic, improved production of Commandaria begins with the establishment of the Cyprus Republic in 1960. From then onwards, there is a continuous upgrading of Commandaria and it begins to be known abroad in typically labelled bottles. At the same time, the safeguarding of Commandaria as a national product of Cyprus is promoted, one produced in a well-defined area under controlled conditions, something which is achieved in the year 1990. The accession of the Republic of Cyprus to the European Union in May 2004 prompted the further upgrading of Commandaria. Despite the fact that it is produced with the same technology as that of three thousand years ago (but now using modern machinery), it not only wins gold medals in international wine competitions, but also the hearts of wine lovers everywhere.

3. RELATED WORK

Only few efforts aiming towards the compilation and presentation of the history of Commandaria in Cyprus or the history of wine production in Cyprus, were recorded in the literature. Cobham (Cobham, 1969) assembles the most

important peregrinations that were written during the Middle Ages about Cyprus. Cobham's book includes a huge number of reports, of high importance not only historically but also important from oenological aspect, since all the writers, without exception, deal extensive with Cyprus wine and particularly with Commandaria. Mariti (Mariti, 1984) describes in graphic details and with clarity of expression the Cypriot conditions of those years and describes in every detail the production of Cyprus wine and Commandaria. Papadopoulos (Papadopoulos, 2004) published a unique book that is dedicated at all to the Commandaria wine. It deals with all subjects that relate with Commandaria such as history, viticulture, geology, legislation, production, and marketing and with the art of enjoyment of Commandaria. Another Papadopoulos' work (Papadopoulos, 2008) contains an itemized description of the long-lasting history of Commandaria, beginning from the prehistoric years up to this very day, proving that Commandaria wine is not only the ancienter known appellation of origin wine but also one of a kind in the whole world that is produced precisely in the same way as it was produced in ancient times.

The book "Vines and Wines of Cyprus, 4000 years of tradition" consists of very important articles related to Cypriot geography and history, wineries and wine making in Cyprus, the viticulture of Cyprus, Cyprus vines, Commandaria, and the Limassol Wine Festival. A book published in 2006 by the Limassol Municipality with the title "Limassol Wine Festival" encompasses a wide range of subjects related with wine accompanied by a huge amount of old and new pictures. Some of the articles are closely connected with Commandaria wine as the main wine that has been traded from Limassol port for many years.

Most of the efforts cited above resulted in books and other written reports that are not easily accessible by wide spectrum of perspective readers from different educational backgrounds. Although few web pages dedicated to Commandaria exist (www.commandariawine.com; www.cypruscommandaria.com) none of them provides in depth scientific information related to the history of Commandaria. As an alternative we propose the design of a user-friendly multimedia interactive system that can be used for disseminating information and knowledge related to Commandaria. This is the first time that an effort in generating a comprehensive digital library that aims to preserve traditions related with Commandaria is undertaken.

4. DATA COLLECTION AND EVALUATION

The data collection activity aims to locate and register all types of items related to Commandaria. As part of these efforts all possible sources of information will be explored. Typically we expect to locate significant data items in:

- Private archives such as the archives maintained by the authors of this paper, archives of wineries, and archives of cooperative banks in the Commandaria region.
- Governmental archives such as the archives of the Ministry of Agriculture, Ministry of Trade and Industry, Council of Wine Products and Oenological Department of Ministry of Agriculture.
- Villages of the Commandaria region (see Figure 1). We plan to stage visits at villages of the Commandaria region, in an attempt to locate any type of data items related to

Commandaria. As part of this effort we expect to locate tools, old type machinery, vessels, mosaics, instruments, photographs and record evidences about Commandaria production.

- National and International Literature.
- Museums such as the Cyprus Wine Museum (www.cypruswinemuseum.com).

A valuable source of information will also be people who were involved in any way with Commandaria. We expect that we will be able to locate mainly elderly people who will be able to provide other information about Commandaria such as traditions, fables and histories of the past and of the present times that are not yet recorded.

The data location process will run in parallel with the process of scientific evaluation so that all findings will be rated according to the scientific value and according to the target audience they refer to. For each item located a data register will be completed, where all relevant information about data items will be recorded. In particular the register will contain the following information: (1) Type of data (document, artefact, buildings, stories), (2) Location of data, (3) Contact Person / Owner, (3) Time period that the data item belongs to, (4) Theme (i.e to which stage of the Commandaria production cycle the data item refers to), (5) Scientific Value, (6) Uniqueness of data item, (7) Target audience (i.e primary school children, secondary school students, University students, tourists, researchers).

5. DATA PROCESSING

During the data processing phase all data items located during the data collection and evaluation process will be digitized and pre-processed using appropriate techniques. Also metadata that summarize basic information about each item will be defined so as to allow efficient and semantically-based retrieval (e.g. "give me all photographs of Commandaria production in the village of Silikou"). For this purpose, and given the diversity of data items, a user-centred approach of requirement (as far as the metadata types are concerned) will be applied. In particular, several categories of users, i.e., students, tourists, researchers, winery employees, government officials, etc., will be asked to submit free text queries to the system in order to get the required information. These queries will be studied, keywords will be extracted and based on these keywords various taxonomies will be defined (e.g "Silikou is a part of Commandaria Region"). These taxonomies of keywords will be formed as an XML schema and will be used for data item annotation through a, properly, developed annotation software. The annotators will be experts in the areas of Cyprus history, sociology and wine production. The results of annotation will be saved in the form of ontology so as to allow reasoning services to be used for data retrieval. That is, a query like "Give me all photographs of Commandaria production items found in the Commandaria region" will return, among others, the linos (i.e., old workshop for producing Commandaria) photographs in Silikou village since linos is a Commandaria production item and Silikou village belongs to the Commandaria region (note, however, that neither linos nor Silikou village were used as keywords in the original query). It is obvious that the metadata taxonomies and other non-hierarchical metadata relations will define ontology's T-Box while the actual annotation metadata will form ontology's A-Box. The Commandaria ontology will be linked with a multimedia repository in order to facilitate

efficient data indexing and data storage of new items. In order to conform to well-defined and publicly used electronic items cataloguing metadata the Commandaria ontology will be based on the Dublin Core metadata elements (<http://dublincore.org/>).

5.1 Digitization and Preprocessing

According to the data type different digitization and processing techniques will be employed. We expect that for the needs of the project the following types of data will be digitized.

Documents: Documents will be digitized using appropriate scanners. Since in various occasions we expect to deal with damaged documents we plan to use dedicated image processing for restoring the appearance of the papers. Examples of damaged documents we expect to encounter in our work are shown in Figure 2. For each document we will need to provide a text-based description that will describe the main contents, so that it will be possible to retrieve documents stored in the repository. OCR methods will be involved whenever possible to retrieve the actual text of the scanned documents. In addition keyword searching will be also performed in the textual-form of the documents to allow for automatic metadata collection. The list of keywords that will be used for this purpose will be retrieved from the ontology.



Figure 2: Examples of damaged documents

Photographs: Old photographs displaying scenes related to Commandaria will be collected and scanned. Where possible the collection of old photographs will be enriched with photographs captured recently. We expect that photographs collected will cover different aspects of the production process, including photographs of vineyards, grape collection, grape drying, production, storage and consumption of Commandaria. As in the case of damaged documents, image processing techniques will be employed for improving the quality of old photographs. Figure 3 shows typical photographs that will be stored in the multimedia repository.

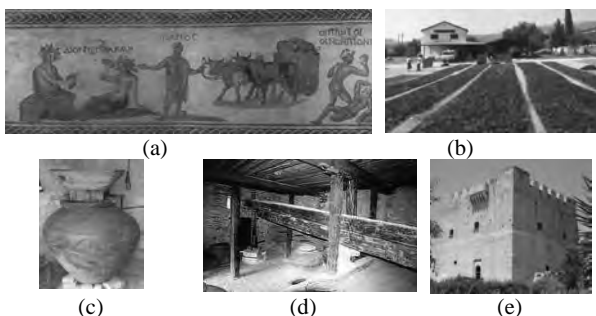

Figure 3: Examples of photographs from the database. (a) 300 bc mosaic found in Paphos, (b) grape drying, (c) traditional wine making tools (d) linos – old workshop for producing Commandaria, (e) Kolossi Castle – a castle related with Commandaria trading during the 13th century

Audio and Video: Audio and video data items will be also collected and stored in the repository. Such data items will come from existing recordings or new recordings. In the case of existing recordings (which most probably are in analogue format) we plan to use audio and video restoration and digitization equipment to preserve the original item and obtain a digital representation of the data.

New recordings will be based on stories and demonstrations provided by Commandaria experts who are willing to share their experiences and stories related with Commandaria.

Artefacts: We plan to use laser scanners for digitizing artefacts and other items associated with the production of Commandaria. Such artefacts will include dedicated tools used (both small size and large size), and whole buildings. Typical items that we plan to digitize are shown in Figure 4. The 3D digitization process will involve the use of a 3D laser scanner for obtaining multiple 3D scans of an object and then all scans will be joined together in an attempt to generate an integrated 3D model of the objects. The pre-processing stage in this case will involve the elimination of holes and noise in 3D models and the application of optimized texture maps. Where appropriate we plan to apply animation techniques in order to demonstrate the operation of various tools associated with the production of Commandaria. For example we plan to generate a 3D model of the wine workshop shown in Figure 3(d) and Figure 5 and demonstrate the operation of the machinery using 3D animations.

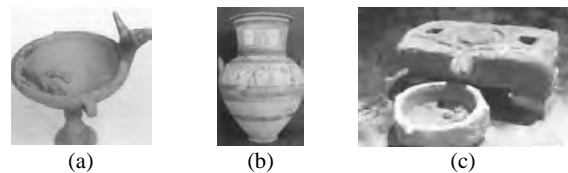

Figure 4: Examples of artefacts we plan to digitize using a 3D laser scanner. (a) wine glass (10th century bc), (b, c) wine vessels



Figure 5: Sketch of the wine workshop for which we plan to generate a 3D animation demonstrating its operation

5.2 Digital Library

The digital form of all data items described earlier will be stored in a digital library consisting of an ontology and a multimedia repository. The former will hold data taxonomies and relations along with metadata while the latter will contain the raw archives (scanned documents, photographs, animations etc.) Obviously links between ontology terms and repository documents will be always present in order to allow access to them through queries. The combination of ontology and multimedia repository will be used instead of a traditional database to allow semantic-based queries, through ontology reasoning, to be executed. The use of ontology will allow prior knowledge about the Commandaria domain to be formally

defined (Staab, 2004). It was stated earlier that the T-Box of the Commandaria ontology will consist of the data taxonomy. This taxonomy will be build based upon a properly designed user-requirement analysis process along with suggestion of experts in the fields of Cyprus history, sociology, and education. In order to conform to open source metadata structures the Dublin Core metadata element set (<http://dublincore.org/>) will be used for the data taxonomy. An indicative set of taxonomies include the user taxonomy, the area taxonomy, the time taxonomy, the production cycle taxonomy, the item type taxonomy, and multimedia content taxonomy. The first four taxonomies can be

more or less predefined while the item type taxonomy and multimedia content taxonomy will result from the user-requirement analysis. With the exception of multimedia content taxonomy the taxonomies mentioned above can be considered domain specific taxonomies (e.g., taxonomies related with Commandaria). Indicative domain taxonomy of Commandaria is shown in Figure 6. For the multimedia content taxonomy a modification of the multimedia hierarchy defined in MPEG-7 (ISO-2001a; ISO-2001b) may be adopted (see also Figure 7).

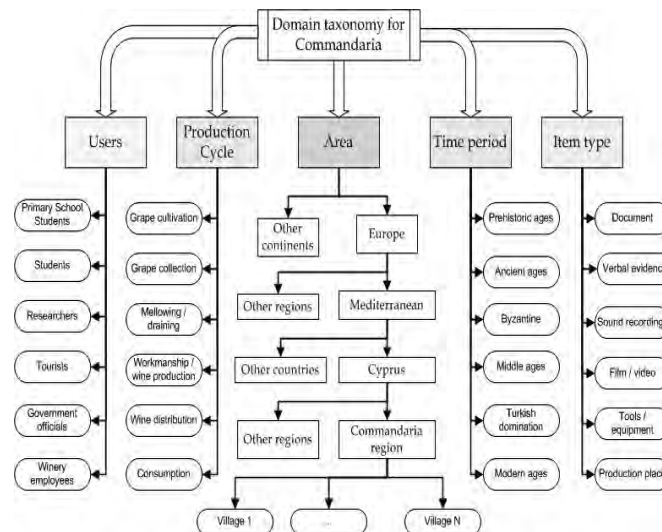

Figure 6: Indicative Commandaria Domain Taxonomy

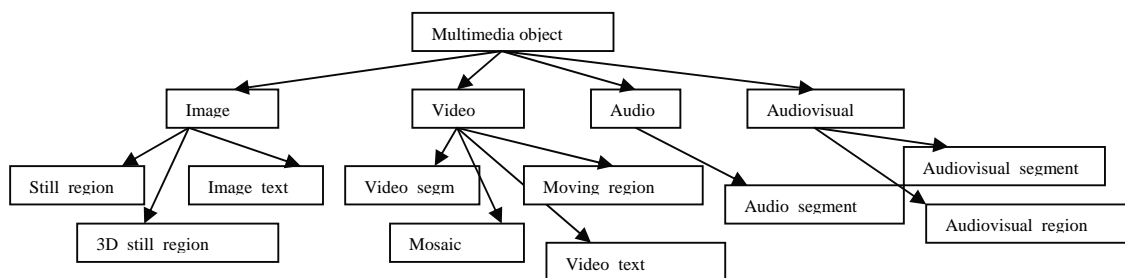

Figure 7: Multimedia Content Taxonomy

6. SYSTEM DESIGN AND EVALUATION

6.1 Interface

An important aspect of the system design is the interface. The interface will take the form of a GIS system, where the map of Cyprus will be presented. Sites related to Commandaria will be marked on the map, so that users will be able to navigate and view data items associated with a certain location. In order to cover the needs of different users, the need of displaying items from a certain time period, the need for displaying items of different type and different thematic content, the user will have the ability to set his/her preferences so that only data items consistent with the user preferences will be displayed on the map. A screenshot of a typical system interface that we are currently experimenting with is shown in Figure 8.



Figure 8: Example of the GIS-based interface

On the map places containing data items related to the user references are shown with spots. By moving the cursor on a

spot the appropriate data is displayed as a thumbnail and if the user decides to explore the highlighted data item he/she clicks on the icon. Clicks on thumbnails activate pop up windows where further information related to the item is displayed. Such information includes text-based descriptions, links to relevant publications, links to sites with relevant information, images, video, recordings and 3D animations.

6.2 System Design

The multimedia content of the Commandaria project will be accessed via a specialized designed interactive graphical user interface. through any computer connected to the internet or through dedicated information kiosks, PDA's, or workstations at the Commandaria museum devoted to the research of the history and culture of the wine.

Figure 9 illustrates the architecture of the proposed system whose main blocks are:

- User interface: friendly GUI that allows the user to interactively use the system.
- Secure Communication and Interaction. Query / Search engine responsible for searching the database according to the parameters provided by the user and securely accessing the data.
- Digitized Content: repository of digitized, compressed images, video clips and documents
- Visual summaries: representation of image and video contents in a concise way, such as thumbnails for images or keyframes for video sequences.
- Indexes: pointers to images or video segments.

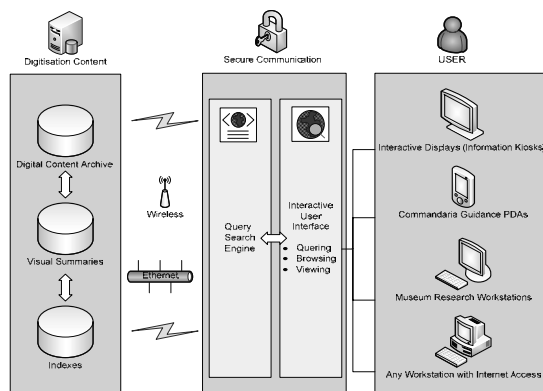

Figure 9: System Architecture

Textual information (metadata) is added to the audiovisual files during the cataloguing stage, with the aid of the ontology, and is used to guide conventional, text-based, query and search engines to find the desired data. Digitization, compression, and cataloguing typically happen off-line. Once these three steps have been performed, the database will contain the image and video files themselves, possible simplified representations of each file or segment, and a collection of indexes that act as pointers to the corresponding images or video segments. The online interaction between a user and the system is represented in the diagram in Figure 8. Users express their query using a GUI. That query is parsed through the ontology's reasoning service and a search engine looks for the link to multimedia repository that corresponds to the desired image or video. The results are sent back to the user via a secure communication link

and in a way that allows easy browsing, viewing, and possible refinement of the query based on the partial results.

6.3 System Evaluation

System evaluation will be performed in three different perspectives: (a) data validity, (b) design, and (c) semantic retrieval performance. Data validity refers to importance evaluation of the collected and digitized items as well as to the integrity and accuracy of metadata. It will be performed by experts in the fields Cyprus history, sociology and wine production. Design evaluation will be performed in terms of usability tests. Usage scenarios will be defined for every user category and users will be asked to implement these scenarios in a scenario walkthrough approach (Rosson, 2001). Particular interest in this evaluation will be given to the educational nature of the system. For this purpose primary school teachers and other educators will be participate in the evaluation. Finally, semantic-based retrieval evaluation will be performed in terms of precision and recall through a relevance feedback (MacArthur, 2002). In particular, users will be asked to perform a number of semantic-based queries and then select the relevant (to their intention) retrieved results.

7. CONCLUSIONS

The history of Commandaria is heavily linked with the Cypriot history and cultural heritage. With our work we aim to design and implement an interactive multimedia system that aims to preserve and disseminate information related to Commandaria. Since this is the first comprehensive approach to generate and make available a digital information dissemination tool for Commandaria, our effort will constitute a major contribution towards national and international efforts of preserving cultural heritage.

So far our work was concentrated on the definition of the methodologies and techniques that we plan to utilize as part of the project. We also completed the draft design of the system including the interface, database schema and mode of operation. In the near future we plan to start the development phase where the data collection and evaluation phase will be completed followed by the data digitization, pre-processing and annotation stage. All data will be organized in a suitable multimedia repository based on the schema presented in section 5.2.

An important aspect of the proposed framework will be the provision of tools that will allow users to add new data items to the database. As a result the proposed system will be turned into an ever expanding and up-to-date data depository that will constitute a major source of information for Cyprus wine and most importantly it will contribute towards the conversation of Cypriot cultural heritage.

8. REFERENCES

References from Journals:

- S. D. MacArthur, C. E. Brodley, A. C. Kak, and L. S. Broderick, 2002. "Interactive content-based image retrieval using relevance feedback", *Computer Vision & Image Understanding*. vol. 88(2).

References from Books:

Cobham CD. 1969. Excerpta Cypria, Publications "The Library", Nicosia.

Mariti G 1984, Wines of Cyprus, Published by NICOLAS Books, Athens.

Papadopoulos K.D. 2004, Commandaria, the legendary wine of Cyprus, Kyproepeia Press.

Papadopoulos K.D. 2008, History of Commandaria, Publisher: Arktinos Ltd, Nicosia.

M. B. Rosson, JM Carroll. 2001. Usability engineering: scenario-based development of human-computer interaction, Morgan Kaufmann Series In Interactive Technologies.

S. Staab, R. Studer, 2004. "Handbook on Ontologies", *International Handbooks on Information Systems*, Springer-Verlag, Heidelberg.

Limassol Municipality Publication, 2006, Limassol Wine Festival.

References from Other Literature:

ISO/IEC 15938-5. (2001, March). FCD information technology-Multimedia content description interface-Part 5: Multimedia description schemes.

ISO/IEC 15938-3. (2001, March). FCD information technology-Multimedia content description interface-Part 3: Visual.

Vines Products Commission, 1993, Vines and Wines of Cyprus.

FROM THE ICE AGE TO THE PRESENT – AN AUDIOVISUAL AND TACTILE MODEL OF THE SWEDISH REGION GÖTA RIVER VALLEY

L. Thuvander^{a,*}, P. Stenborg^b, J. Ling^b, C. Sevara^b, M. Söderström^c, J. Tornberg^a

^a Dept. of Architecture, Chalmers University of Technology, 41296 Gothenburg, Sweden -
(liane.thuvander, jonas)@chalmers.se

^b Dept. of Archaeology and ancient history, University of Gothenburg, 40530 Gothenburg, Sweden -
(p.stenborg, johan.ling)@archaeology.gu.se, csevara@yahoo.com

^c Dept. of Soil Sciences, Swedish University of Agricultural Sciences, Skara, Sweden - Mats.Soderstrom@mv.slu.se

KEY WORDS: animation, audiovisual model, mediation, museum, tactile model, virtual model, visualization

ABSTRACT:

This paper describes a project in progress dealing with visualization and mediation of archaeological and cultural heritage information by integrating digital tools in a museum exhibition. In the project an interactive, combined digital and physical model representing the Göta river valley in south-western Sweden is developed. The objective is to utilize audiovisual and tactile information to illustrate the historical development of the region and to communicate historical knowledge in a museum environment in an innovative manner. Although the project is directed to all museum visitors, the focus audience consists of young students and visually impaired. The model comprises three parts: an animation, an audio track, and a tactile model. The animation, together with the audio track, illustrates the landscape development of the valley from the ice age until present. The animations are based on spatial data and calculations for land uplift and shoreline-displacement. The tactile model functions as a background for the projection of the audiovisual component and as communication interface to the visually impaired through a number of unique surface finishes. A first version of the digital model was installed at Lödöse Museum at the end of 2007. In November 2008 the combined model will be inaugurated and an evaluation of the visitors' perception of the model initiated. Feedback has been gained continuously from museum staff and visually impaired, which has influenced the production of the final model. The results of the study will improve knowledge about the impact of digital applications within archaeology and the cultural heritage sector.

1. INTRODUCTION

1.1 Background and aims

Technical developments over the latest decade have had significant influence in the field of archaeology and cultural heritage management. Digital applications have had a considerable impact, particularly on data collection and field documentation methods (e.g Conolly & Lake, 2006; Stenborg, 2007; Wheatley & Gillings, 2002). However, the dissemination of this kind of information to the public by means of digital methods and data is still comparably uncommon.

The paper describes and discusses a project in progress which deals with digital visualization and mediation of archaeological and cultural heritage information by integrating digital tools in an ongoing museum exhibition. In the project an interactive, combined digital and physical model representing the Göta river valley in south-western Sweden is being developed for museum visitors. The objective is to utilize both audiovisual and tactile information to illustrate the historical development of the region and by that to mediate historical knowledge in a museum environment in an innovative and unique manner. Although the project is designed to communicate information to all museum visitors, the main focus audience within that sphere consists of young students and the visually impaired. Visualizations and models must hold a certain design quality in order to generate relevant response (Neto, 2003) at the same time it is important to emphasize the content, i.e. the empirical information which is communicated. An overall question is how

empirical objectivity and authenticity can be combined with and balance visually convincing representations.

1.2 Overview and reference to related work

During the last years 3D techniques, Virtual Reality (VR) and Augmented Reality (AR) have been increasingly implemented as a pedagogical tool for visualization and mediation of archaeological and cultural heritage management information (Lock, 2003; Tringham, 2004; van Raalte et al., 2004). Examples include: Time based information and communication of historical maps online in the form of map animations, e.g. the Australian TimeMap Project (www.timemap.net/, Johnson and Wilson, 2003; Johnson 2004), and the possibility to fly around in virtual environments based on historical maps draped over a digital elevation model, e.g. the Swedish Djurgården landscape project (www.djurgarden.se/landskapet/). These examples include a time perspective, but communicate historical information only digitally and do not address target groups such as visually impaired.

The use of relief models and tactile surfaces for information mediation together with an audio track to visually impaired (Almeida/Vasconcellos & Tsuji, 2005) and in museum environments is not new. However, usually historical landscapes or sites represent one specific time period and rarely include changes through time. It is even rarer that they include time series directed to communicate with the visually impaired. In the project Västsvenska Handelskammaren (2003) different types of geographic data were projected on a physical model to

* Corresponding author.

visualize population structures, occupations, transport systems, etc. and were able to be selected interactively. In the project a digital and physical model is combined, however, only one time frame is illustrated and the physical model is only explored in a visual way.

The Göta river valley project “From the ice age to the present” intends to fill some of the above mentioned gaps. A digital and tactile model is combined to illustrate and communicate the historical development of a region, implemented into a museum environment and with focus on the accessibility for visually impaired. The concept is being tested in cooperation with an archaeological museum in south-western Sweden, Lödöse museum (www.lodosemuseum.se), where the combined model will be integrated in an ongoing exhibition about the history of archaeology: “Images of our ancestors”. This exhibition focuses on the history of archaeology and how differently the traces of our ancestors have been interpreted during time. This exhibition also incorporates a number of learning stations for school classes. The Göta river valley model is thus a component of one station.

In the following text, the digital and tactile models are described in detail; how they are constructed, what data they are based on and what content they will house.

2. DIGITAL MODEL

2.1 Animation

An animation of the historical development of the Göta river valley has been created with the objective to compile and communicate existing knowledge from different sources in a new, visual and pedagogical way. The animation illustrates the development of the cultural and natural landscape of the valley area from the end of the last ice age (12500 B.P.) to the present day, and will cover an area of roughly 3000 km² illustrating the following themes: shoreline-displacement (due to sea-level fluctuations and glacial isostatic adjustment), vegetation development, land-use and agriculture, human occupation and settlement, routes of communication, and archaeological sites. To take into account the needs of visually impaired, the choice of distinct colors, contrasts, and light quality is essential.

A first version of the animation was based on a geographic information system (GIS) model generated using ArcGis 9.2 (www.esri.com) and XTools Pro 5.0 (Figure 1). In order to produce a smoother animation, the final version will be key-framed in a professional animation program.

A 25m interval grid digital elevation model (DEM) was interpolated from a 50m interval point lattice obtained from the GSD-Terrain Elevation Databank (National Land Survey of Sweden, www.lantmateriet.se) for use as the main elevational base-dataset in the model.

Simulation of the past sea level was implemented through a mathematical algorithm, developed by professor Tore Pässe (Klingberg et al., 2006; Pässe, 2003; Pässe & Andersson, 2005), whereby the prevailing situations at nine points in time were simulated. Additional “time-frames” were generated by several other procedures, including contour functions and tools for buffering. Figure 2 illustrates some of the time slices of the animation.



Figure 1: The exhibition hall at Lödöse Museum. A first version of the digital model, the animation, was installed at the end of 2007 and projected on a vertical screen. Photo: Per Stenborg.

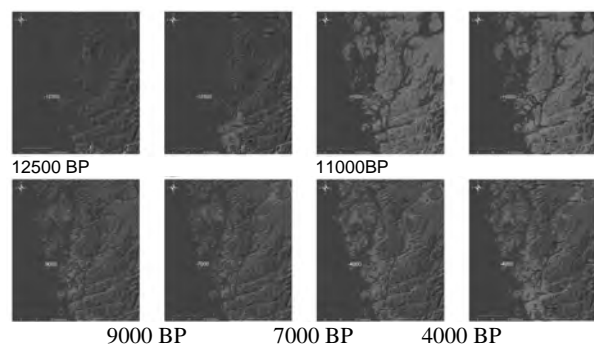

Figure 2: Images from the animation of the Göta river valley landscape: shoreline-displacement for the time periods 12500 B.P./11000 B.P./9000 B.P./7000 B.P./4000 B.P.. Per Stenborg.

Do not use any low contrast photocopying For the illustration of the vegetation development, layers will be built from the results of pollen analyses of samples taken in bogs and lakes in Western Sweden (Persson, 2003; Welinder et al., 1998; Ytterberg, 2006). These layers will simulate the proportional distribution of vegetation types, rather than the precise presence (or absence) of particular species. The present vegetation distribution and land cover is illustrated by data from the GSD-Land and Vegetation Cover database (www.lantmateriet.se). Further, historical maps will be investigated as a source of data to accomplish the description of vegetation development in the Göta river valley. The animation will not only show the proportional distribution of the vegetation but also contain pollen-diagrams to illustrate what the interpretation in the animation is based upon.

Different categories of archaeological sites derived from the Swedish National Record of Sites and Monuments (FMIS, www.fmis.raa.se/) will also be included in the animation. It is important to communicate that these sites only represent known sites, whereas the “real” number of sites may be considerably greater. This theme will allow discussing the issues of the role of interpretations, empirically gained knowledge, authenticity and visual experience.

Communities are represented by vector polygons which define their area and location. During the animation the outline of the communities are as they are today to give the visitors the

possibility to relate the animated process to known geographic reference features. The origin and growth of these communities will also be animated from a time perspective. Additional information to include in this component of the animation may be communication routes and landmarks.

Another idea is to link the historical development to topics of current interest such as climate and environmental change, or green house gas effects. This will be realized by comparisons between phenomena such as the flooded settlements of the Mesolithic era (as a consequence of transgression periods) and current fears of sea level rise caused by global warming. Thus, two hypothetical future scenarios of the landscape development of the Göta river valley will be added based on these parameters.

2.2 Audio track

The animation is accompanied by an audio track which aims to explain the themes of the model in a pedagogical manner. As the overall exhibition is mainly directed towards school classes and younger teen-agers, a 15 year old girl was chosen as speaker. The audio track has also been adapted to suit the visually impaired. For example, explanations of the animation content are balanced with descriptions of the underlying model and events of the animation, i.e. what you can see right now in the animation. In the first version, the audio track will consist of a spoken monologue in Swedish and English. In a later, revised version of the audio-visual animation sounds representing different time periods may be included. These sounds may represent the natural environment or the sound related to humans activities.

The audio track starts with an overview of the composition of the exhibition room, the course of events about to be shown and an introduction to the main feature of the room (i.e. the digital-tactile model). The objectives of the model are mentioned, the principals of the seven tactile surfaces and their information content introduced (see Chapter 3), as well as how to use the tactile model. Next, the screenplay of the animation is described and the possibilities of interaction are explained. Thereafter, the overall composition of the model is described. The animation then runs and halts according to the story; e.g. to describe and explain dramatic changes of the shore-lines, or when areas or places of particular interest become visible. A description of the depictions of the landscape's composition at particular moments in time is provided along with an account of the processes of change illustrated by the animation. Also, scientific backgrounds are given concerning the interpretations of historical situations (e.g. researchers may have found pollen of birch trees and may allocate it to a particular time period).

The introduction part of the animation audio track may also be combined with the DAISY digital guide (www.daisy.org) the museum uses for the related exhibition "Images of our ancestors". The audio track is produced by a professional sound technician. The animation (inclusive audio track) will not only be presented at Lödöse Museum but also online via the homepage of the Digital Time Travels project; <http://www.time-travels.org>.

3. TACTILE MODEL

As mentioned above, the development of the Göta river valley from the Ice Age to present is not only modeled digitally but

also physically. A tactile model of the valley at a size of 1,20m x 4,27m (fits 2 x 16:9 widescreens) has been constructed with the objectives a) to function as a background for the projection of the audiovisual model, and b) to communicate historical information to the visually impaired. For that, the relief of the Göta river valley topography is combined with a number of different surface treatments. Therefore, the most challenging part is the design of the time perspective and the balance of the information load.

The tactile model represents present day topography of the landscape on which three time periods after the ice age are illustrated. The topography of the model is constructed based on contour lines calculated from DEM and printed on a paper map covering the entirety of the tactile model.

Altogether, the model contains seven different tactile surface structures with the following information content: a) a glossy surface representing water surfaces, b) a convex raster surface representing land area at the time 12500 B.P., c) a smooth surface representing the time period 12500-7000 B.P., d) a sandpaper-like surface representing the time period 7000 B.P. until present, e) a waffle-shaped surface representing the area of distribution of present day population centers, f) pin-points marking the eight archaeological sites which are presented in more detail in the museum exhibition, and finally g) Braille of the names of the settlements and archaeological sites. The transposition from one time period to another and the borders of the settlements are very clearly marked by convex lines. A further measure to improve the tactile properties of the model is the exaggeration of the height by a factor of approximately ten.

The physical model is one solid model, manufactured by the Academy of Shaped Design in Lidköping, Sweden (Figure 3, Formakademin, www.formakademin.se) and constructed in three steps

- A positive model in clay, constructed over the isoline map on a base of 5 mm foam boards. The step-like differences in height are leveled out with clay and water surfaces are modeled by a window pane (Figure 4).
- A negative model in gypsum. The clay model functions as mould for the gypsum cast.
- A final model in epoxy. After drying of the gypsum model and treatment with linseed oil, the tactile model is produced in the plastic material epoxy, and will have a weight of about 70-80kg.

The final surface treatment is a spray paint in a grey color nuance (Natural Colour System®: NCS S-4500-N) to provide the best conditions for the animation with regard to contrast and color projections. The tactile model, then, is placed on a stand which is mounted on the floor in the exhibition hall at Lödöse Museum to avoid unwanted displacement, though this will allow the model to be moved temporarily, as the exhibition hall is also used as auditorium. Once on the stand, the model has a similar shape to a table and has a free height of about 70cm to enable wheel-chairs access to at least a half of the model and to offer a comfortable height for people to easily interact with it.



Figure 3: Towards a tactile model. Students at the Academy of Shaped Design in Lidköping manufacture the positive clay model (1,20m x 4,27m). Scale 1:20000. Photo: Liane Thuvander.



Figure 4: Step one, a positive clay model based on foam boards. The white lines mark the crossing of time periods. Photo: Liane Thuvander.

4. A COMBINED DIGITAL AND TACTILE MODEL

Finally, the audiovisual and the tactile model are combined with the purpose to increase the experience and accessibility of historical information to a broader segment of the public. The animation is projected by two high resolution (HDMI) projectors installed above the tactile model (Figure 5). A crucial part is the synchronization of the tactile model and the projection of the animation to get an as good as possible correspondence between the information content of the digital and tactile model.

The animation will occasionally halt to explain the course of events. Interaction related to the animation is realized via a touch-screen enabled computer station next to the tactile model table. One can start or stop the animation whenever wanted, select parts of the animation, change the language and finally choose between two different future scenarios related to the rise of the sea level.

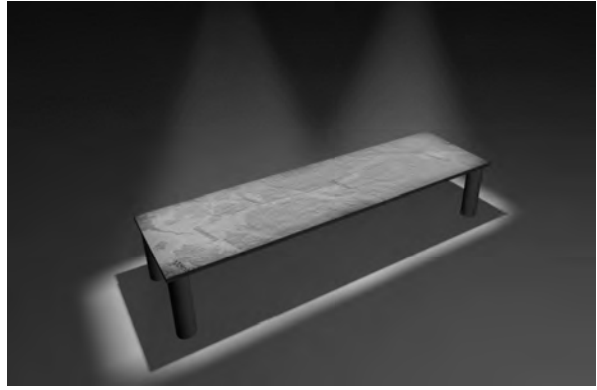

Figure 5: Animation projected on a tactile model specimen. A virtual mock-up of the Göta river valley.

5. DISCUSSION - FEEDBACK AND EVALUATION

The whole modeling work is based on formative feedback and evaluation processes and is carried out iteratively. New competences and cooperation partners are linked to the project as needed. For the audiovisual and tactile model, the continual feedback from museum staff and a representative of the Swedish Association of the Visually Impaired has been used as guideline for the modeling work. Various methods for feedback and evaluation have been and will be applied, such as meetings with different actors, focus group interviews, surveys, video filming, and feedback from a scientific reference group.

The overall design of the audiovisual and tactile model is the result of the cooperation of the project group and staff from Lödöse Museum and the representative from the Swedish Association of the Visually Impaired. After installing a first version of the animation (Figure 1) the scenario idea came up by the museum staff to improve the pedagogical and interactive part of the model. Another idea was to integrate the model with the ongoing exhibition "Images of our ancestors", something which did not form part of our initial plans. In this exhibition, Lödöse Museum focuses on accessibility for the visually impaired and an integration of this into the digital model was needed, which was a real challenge. Thus, the idea of the combined digital and tactile model was born. This part is mainly based on internal feedback and evaluation (project group, museum staff, representative for the visually impaired).

5.1 Creation of the digital model

The animation is commented by the museum staff from a pedagogical point of view. The scientific reference group has provided feedback on the content and technical issues such as choice of software. For discussion and improvement of contrast and color settings and finding an appropriate speed for the illustration of changes, an informal group interview/focus group interview will be carried out with two to three persons having different levels of impaired vision.

The manuscript for the audio track is written and revised continuously by the project group after being commented by the museum staff from a pedagogical point of view and by the representative from the visually impaired perspective. A speaker voice test has been evaluated by the project group members, the museum staff and the visually impaired.

5.2 Production of the tactile model

Several model prototypes have been manufactured in order that a representative of the Swedish Association of the Visually Impaired would be able to test different tactile surfaces and structures of the physical model (Figure 6). From the test results, decisions are taken regarding what kind of structures to include, the sequence of the structures, etc. One lesson learnt is, for example, that convex structures work much better than concave structures and information overload must be avoided as visually impaired persons only can manage a limited number of different information content. The tactile model can be revised during the production phase, however once it is produced, options for modifying the surface become limited. Therefore feedback such as this at early stages is critical to the production of a useful tactile surface for the model.

Another discussion has dealt with the question of how many pieces the model should consist of. One piece is preferable considering the projection and from an esthetic point of view. From a more practical point of view, the idea of dividing up the model into four pieces was initially discussed. This would allow the museum staff to be more easily able to move the model as needed. However, this solution raised problems regarding how to secure stability, fitting joints and correct projection of the animation. In the end, the museum was able to come up with a solution for handling a one piece model on a removable stand.



Figure 6: Visually impaired test of different tactile surfaces for the physical model. Photo: Liane Thuvander.

The design of the model is based on the feedback from various sources, including: members of the project group, staff and students from the Academy of Shaped Design, the representative of the Swedish Association of the Visually Impaired, and the museum staff at Lödöse Museum.

5.3 Combination of the models

A first evaluation of the combined audiovisual and tactile model by external groups will be carried out in connection with its installation at Lödöse Museum. About 2-3 pilot classes will be invited from schools nearby the museum and from the visually impaired community. The evaluation will be based on video filming of the pilot classes to study how the people move around the model, how they explore the tactile properties of the model, and to monitor their reactions. In addition, half structured interviews with visitors will be carried out to study how the model is perceived in general, how the information mediation works, how the audio track is working together with

animation and the tactile model, what the positive and negative impressions are and what to improve.

The model will be revised after evaluation of the comments from the pilot classes. The model will subsequently be presented to the public as an official part of the ongoing exhibition "Images of our ancestors" and will be used for educational purposes.

In the public part of the evaluation, both the model itself and communication aspects are to be studied. This evaluation focuses on external peoples' viewpoints, i.e. persons who have not been involved in the modeling work. The evaluation will be based on an internet survey, using tools provided by SurveyMonkey.com. The internet based questionnaire survey will be available at Lödöse Museum. Another opportunity to gain feedback from the public is via the web forum of the project, <http://forum.time-travels.org>. This forum can also be used by web domain visitors to comment on the audiovisual part of the model. Finally, everyone involved with the design and production of the model will be interviewed to reflect on the overall process.

6. CONCLUSION

A first version of the digital model was installed at Lödöse Museum at the end of 2007 (Figure 1) and made available on the internet domain of the Digital Time Travels project (www.time-travels.org/stud1_2.html). In November 2008 the combined model will be inaugurated at Lödöse Museum (Figure 7) and an evaluation of the visitors' perception of the model initiated. The tactile model is almost finished and the digital model is gradually elaborated. The feedback process is ongoing.



Figure 7: Exhibition hall at Lödöse museum where the model will be placed in addition to the ongoing exhibition "Images of our ancestors". Photo: Per Stenborg

The formative feedback from all partners has been very valuable. It is an important part of the research process and influences the results to a large extent. This feedback process will be continued. Even after presenting the model to the public, development of the model will continue. Thus, the first model is a basic version which will be improved and extended step by step, e.g., by adding new themes to the animation.

The model utilizes both audiovisual and tactile information to illustrate the historical development of the region, having visually impaired people and young students as two particular target groups. Results from the study will improve our knowledge about the applicability and effect of digital

applications as instruments for mediation and communication in archaeology and cultural heritage management.

7. REFERENCES

References from Journals:

Johnson, I. and Wilson, A., 2003. The TimeMap Project: Developing Time-Based GIS display for cultural data. *Journal of GIS in Archaeology*, Vol I, pp. 123-135.

Johnson, I., 2004. Putting Time on the Map. Using Time Map™ for Map animations and Web Delivery. *GEOInformatics*, July/Augusti 2004, pp. 26-29.

Neto, P. L., 2003. Design Communication: Traditional Representation Methods and Computer Visualization. *Visual Resources*, Vol 19 (3), pp. 195-213.

Påsse, T. and Andresson, L., 2005. Shore-level displacement in Fennoscandia calculated from empirical data. *GFF*, vol 127, pp. 253–268.

References from Books:

Almeida/Vasconcellos, R. and Tsuji, B., 2005. Interactive Mapping for People Who are Blind or Visually Impaired. In *Cybercartography*, Theory and Practice, ed. By Taylor, F.D.R., Elsevier, Amsterdam, pp. 411-431.

Conolly, J. and Lake, M., 2006 *Geographical Information Systems in Archaeology*. Cambridge Manuals in Archaeology, Cambridge University Press, Cambridge.

Lock, G., 2003 *Using Computers in Archaeology: Towards virtual pasts*. Routledge, London.

Welinder, S., Pedersen, E. A., and Widgren, M., 1998. *Jordbrukets första femtusen år 4000fKr-1000eKr*. Natur och Kultur.

Wheatley, D. and Gillings, M., 2002. *Spatial technology and archaeology. The archaeological applications of GIS*. Taylor & Francis, London & New York.

References from Other Literature:

Klingberg, F., Påsse, T. and Levander, J., 2006. Bottenförhållanden och Geologisk Utveckling i Göta älv. Sveriges Geologiska Undersökning, K43, Sweden.

Persson, P., (ed.) 2003. Strandlinjer och vegetationshistoria. GOTARC serie C, No 48, Arkeologiskt Naturvetenskapliga Laboratoriet, Sweden.

Påsse, Tore 2003 Strandlinjeförskjutning i norra Bohuslän under Holocen. In *Strandlinjer och Vegetationshistoria*, ed. by Persson, P., GOTARC Series C., No 48, pp. 31–88.

Stenborg, P. 2007. Digital Stenålder: Datorålderns kulturmiljövård, ULI-aktuellt Nr 2, 2007, s. 4–5. Utvecklingsrådet för Landskapsinformation (ULI), Gävle.

Tringham, R., 2004. Interweaving Digital Narratives with Dynamic Archaeological Databases for the Public Presentation of Cultural Heritage. Proceedings of the 31st Conference *Enter the Past: The E-way into the Four Dimensions of Cultural Heritage*, CAA 2003, Computer Applications and Quantitative Methods in Archaeology. Vienna, Austria., 2003, pp. 196–199.

v. Raalte, S., Källman, R. and Wikström, T., 2004. A Cultural Heritage Dialogue: IT Support for Reflections on the Present and Future. Proceedings of the 31st Conference *Enter the Past: The E-way into the Four Dimensions of Cultural Heritage*, CAA 2003, Computer Applications and Quantitative Methods in Archaeology. Vienna, Austria, Apr. 2003, pp. 518–520.

Västsvenska Handelskammaren, 2003. Bygg färdigt Västsvensk Väg och Järnväg, Rapport 2003:1.

Ytterberg, N. (red.), 2006. Flyktiga förbindelser. Arkeologiska undersökningar inför den nya gasledningen Göteborg - Stenungsund. Bohusläns museum.

References from websites:

(all accessed 23 June 2008)

DAISY digital guide: <http://www.daisy.org>

Digital time-travels: <http://time-travels.org/>

Djurgården: <http://www.djurgarden.se/landskapet/default.aspx>

Esri: <http://www.esri.com>

FMIS: <http://www.fmis.raa.se/>

Formakademin: <http://www.formakademin.se>

Lödöse Museum: <http://www.lodosemuseum.se/>

National Land Survey of Sweden: <http://www.lantmateriet.se>

TimeMap: <http://www.timemap.net/>

8. ACKNOWLEDGEMENTS

The Göta river valley case is a part of the research project “Digital Time-travels: New strategies for archaeology and cultural heritage management?” funded by the Swedish National Heritage Board and the Friends of the Blinds and is organized as a joint venture between the Dept. of Archaeology and Ancient History at Gothenburg University, the Dept. of Architecture at Chalmers University of Technology, and the Dept. of Soil Sciences at the Swedish University of Agricultural Sciences. The project is carried out in co-operation with archaeological museum in Lödöse and the Swedish Association of the Visually Impaired. Special thanks go to Lena Stammarnäs, Jenny Ekelin Ekberg, Sonia Jeffery at Lödöse Museum, Anders Josby, the Swedish Association of the Visually Impaired, Johan Malmström, Nina Bergqvist, Bengt Broberg, Corina Akner, Louise Börjesson, Albin Löfqvist, Mikael Jansson, at Academy of Shaped Design in Lidköping and finally to Magnus Axelsson, sound.

RESTORATION OF AGED PHOTOS BY COLOR TRANSPLANT

A. Del Mastio, F. Uccheddu, V. Cappellini

DET - Department of Electronics and Telecommunications
University of Florence, Via Santa Marta 3, Florence, Italy;
(delmastio, uccheddu, cappellini)@lci.det.unifi.it

KEY WORDS: color transplant, color restoration, image processing, Cultural Heritage

ABSTRACT:

Starting from XVIII century, images have been used to testify the historical memories of the society. Among others, they are used for the representation of ancient documents, art objects, and similar. Even if the photographic technique has got several improvements since its origin, photos are still liable for several damages, both concerning the physical support and the colors and figures which are depicted in it: scratches or rips are examples of common physical injuries, while the fading or red (or yellow) toning of its colors are representative of “chemical” damages. In this paper, a novel method able to infer the original beauty of digital reproductions of aged photos is presented. It is based on the comparison between the degraded image and a not-degraded one, showing similar contents; that is, it is possible to transplant the colors coming from the not-degraded image in the degraded one. Similarly, the method can be also applied to digital reproductions of faded goods. The key point is a dualism between analytical mechanics and color theory; that is, the scatter plot diagrams of x and y normalized coordinates of the colors of both the images are computed, and each of them are accounted as a system of point masses, thus provided of an inertia ellipsoid and inertia axes. To perform the color correction of the degraded image, the inertia ellipsoid of it is moved up to overlap the not-degraded one, thus performing a transplant of colors.

1. INTRODUCTION

In 1935, the marketing of the first slide film, the Kodak Kodachrome which is still on the market, started; this was just before of the Agfacolor by Agfa, in 1936: the age of the modern color photography was begun. Three layers of film are joined together; separately, they are sensitive to blue, green-blue and red-blue: by the use of suitable filters, the lower layers are forbidden to blue component of light, thus being sensitive only to green and red. (Bellone, 1981)

Starting from its origin, photography is based on some requirements: a plate of light-sensitive material, an exposure of variable duration, a post treatment of the plate for the development and/or the stabilization of it. The photo-types was firstly composed by organic materials, which was very feeble and could be easily damaged by chemical, physical and biological agents, both concerning the support and the light-sensitive emulsion. For example, below is reported a non-exhaustive list of possible damaging agents:

- **Light sources:** light bleaches the red, green and blue image coloring in different ways; as a consequence, light implies to photos a general fading and a change in colors;
- **Humidity, temperature:** their actions are strictly related, varying the percentage of relative humidity of the air, whose high level entails the emulsion to swell, colors to fade, moulds to proliferate; on the contrary, if relative humidity is too low, cracks can appear on the surface;
- **Smog, pollution:** polluted air contains a mix of strongly aggressive oxidative elements, which are strongly affect the conservation of photos;
- **Bad conservation:** a long time conservation is based on an effective protection, involving requirements on photo holders which are often hard to satisfy.

Digital images of Cultural Heritage goods have been used for a long time for documentation purposes, reducing the conservation tasks just to the preservation of the digital support. In recent years, image processing tools have proven that they can be profitably used with study and research aims,

for example producing new versions recovering the original appearance of the good (Martinez, 2002 – Bonacchi, 2001).

In this paper, we present an algorithm able to infer the original aspect of a photo after the ageing process it has suffered, estimating a digital reproduction of the degraded content as it probably was in the original aspect. The method is based on the comparison of the degraded image with a not-degraded one, showing similar contents and, if possible, similar lighting conditions; the transplant is computed exploiting a dualism between the analytical mechanics and the color theory, in particular between the point masses systems and the scatter plot diagrams of the x and y normalized coordinates of colors in the images. On the basis of this dualism, we consider the scatter diagram as a system of point masses, thus provided of a “center of mass”, an “inertia ellipsoid” and “inertia axes”. The algorithm “moves” then the degraded inertia ellipsoid up to superimpose the not-degraded one, thus correcting the degraded colors.

In the following, some notes concerning the Colorimetry are given in section 2; in section 3, the algorithm is depicted; some experimental results are shown in section 4, to validate the process itself. Conclusions ends the paper.

2. NOTES ABOUT COLORIMETRY

Colorimetry is a field of Color Science; it concerns, among others, the specification of colors of a visual stimulus, from a numerical point of view, linking up some physical unambiguous measurements.

A color is a characteristic of a radiant light impressing the visual system of an observer; it varies depending on the emitted and perceived wavelengths reaching the human eye, as well as a light-sensitive material or device.

The main organization dealing with colorimetry items is the CIE (Commission Internationale de l'Eclairage); CIE issues standards and measurement procedures for the use of colorimetry in scientific and technological fields, by drafting

recommendations and reports which are an important focus for all the scientific community. (MacAdam, 1993)

2.1. RGB and XYZ color spaces

The first colorimetric coordinate system defined by CIE is the *CIE-RGB*. Each color is defined by mixing three primary colors, Red, Green and Blue (RGB), whose wavelengths are 700 nm. (Red), 546.1 nm. (Green) and 435.8 nm. (Blue). The CIE-RGB is the standard for all the rendering systems (monitor, displays, ...) and for all the acquisition systems (scanners, digital cameras, ...). A great portion of the visible spectrum can be represented mixing with different proportions the three primary colors. Usually, each one of the RGB coordinates is represented by means of 8 bits, thus allowing 16,777,216 different combinations (and thus different colors).

One of the limits of the RGB color space is that it is not able to represent all the existing colors; thus, another color space has been defined: the CIE-XYZ. This is based on three different primary colors, the X, Y and Z, which are not physically available and thus called imaginary. The Y is related to the luminance of the radiant spectrum, as perceived by the human eye; the relations between the RGB and XYZ color spaces can be expressed through known equations. (Wyszecki, 1982)

2.2. The xy Chromaticity diagram

In order to simplify the representation of the XYZ color space, usually a normalized chromaticity coordinates space *x*, *y* and *z* is computed, starting from each set X, Y and Z, such as:

$$\begin{aligned} x &= \frac{X}{X + Y + Z} \\ y &= \frac{Y}{X + Y + Z} \\ z &= \frac{Z}{X + Y + Z} \end{aligned} \tag{1}$$

where *x*, *y* and *z* are dependant among each other, i.e. by means of equation (1), a color can be identified by only 2 coordinates, usually *x* and *y*. Since for an absolute representation of colors it arises the need of 3 independent values, the luminance information Y is also counted.

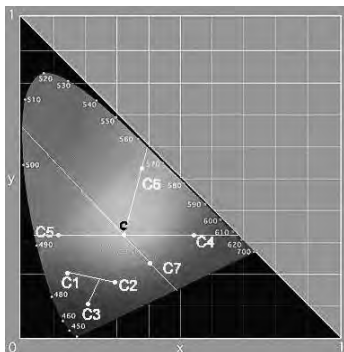

Figure 1: The normalized chromaticity diagram *xy*

Figure 1 represents the normalized chromaticity diagram *xy*; in it, all the possible colors for which the total intensity is

constant and equal to 1 are shown; the other hues that can be represented need to specify the luminance value Y as well as the *x* and *y* coordinates. All the colors that can be represented in the *xy* chromaticity diagram lay on the black triangle depicted in Figure 1, while the CIE area of real colors is the bell shaped area depicted inside.

Referring to Figure 1, some notes can be stated: (Field, 1988)

- the point C represents the CIE Enlightener, that is the point corresponding to the radiation emitted by a white surface enlightened by an average daily light;
- over the curved perimeter of the bell-shaped diagram are located all the spectral colors at their maximum saturation;
- over the straight segment on the basis of the diagram are located all the not-spectral colors, called crimsons, at their maximum saturation;
- keeping into account two different colors (for example C1 and C2 in figure), the segment joining them represents all the possible additive mixtures for them; if C belongs to this segment, as for C4 and C5 in figure, C4 and C5 are complementary between each other, i.e. their mixture can give the reference white.

3. CORRECTION OF DEGRADED COLORS

The proposed method deals with digital versions of photos subjected to chemical damages, in particular with fading and/or yellow or red toning. The algorithm infers the original appearance of a degraded photo, thus reverting the ageing process it has suffered.

The basic idea is a comparison between the degraded image (the original image) and a not-degraded one, the reference image; the only requirements the reference image has to satisfy is to show contents similar to the original image, and if possible under similar enlightening conditions, also.

Note that the comparison is global, i.e. it involves the whole images; a point to point comparison wouldn't be suitable, since the reference and original images represent similar contents but not exactly the same ones.

The global comparison is performed by computing first the scatter-plot diagram of the *x-y* normalized coordinates of the two images. On the basis of the dualism between analytical mechanics and color theory, each one of the diagrams is considered as a point masses system, thus provided of moments of inertia, in turn defining an inertia ellipsoid and two inertia axes (see Figure 2 on the left).

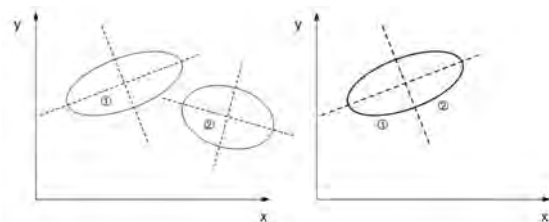

Figure 2: Inertia ellipsoids and axes: on the left, the two inertia ellipsoids of the reference (1) and original (2) images; on the right, the two ellipsoids after the correction.

The correction is performed by moving (translating, rotating and scaling) the inertia ellipsoid coming from the original

image up to overlapping the inertia ellipsoid associated to the reference image (see Figure 2, on the right). The effect of this combination of geometrical transformations is the transplanting of the colors belonging to the reference image in the original image, thus simulating a reverse ageing of the photo itself. Note that the more the scatter-plots are similar to ellipses, the better results are achieved.

3.1. From the image to the scatter-plot diagram

The scatter-plot diagram is a three-dimensional graph, depicting the correlation of two sets of data; the two sets are represented on the x and y-axis of the diagram, while the occurrences of each pair are represented as a gray level at their intersection: the more occurrences the pair has the higher is the gray level of the intersection point (thus the more lighter is the color; remember that black correspond to the minimum value, i.e. 0, while white corresponds to the maximum value, usually 255 if the gray-levels are represented with 8 bit).

In our algorithm, the two data sets are represented by the x and the y normalized chromatic coordinates of the image points, while the occurrences are the number of pixels assuming that particular pair of chromatic coordinates (see Figure 3).

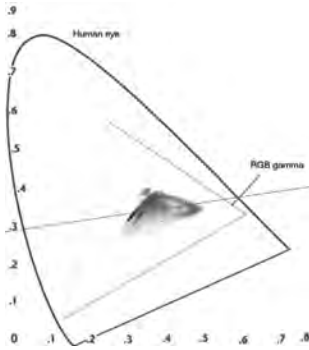

Figure 3: Negative representation of the scatter-plot diagram of an image.

A null value of a point in the diagram means that no pixels assume the corresponding pair of coordinates; this is associated to the black color. The diagram is also stretched to the maximum number of occurrences, so that the maximum is associated to the white. Note that in Figure 3 a negative version of the scatter-plot is depicted, to improve the readability of the diagram. The triangle shown in figure represents all the colors which can be represented in the RGB color space.

3.2. Point mass systems and the xy Chromaticity diagram

Once the scatter plot has been computed, it can be regarded as a system of point masses. From analytical mechanics, the total mass of such a system is the sum of the single point masses:

$$m = \sum_{P_i} m_i \quad (2)$$

where P_i represents the whole set of point masses.

Concerning the scatter plot, the masses of the system are related to the occurrences of the coordinate pair; as a

consequence, the total mass of the scatter-plot diagram is the total number of pixels belonging to the image.

Again, similarly to each point masses system, on the scatter-plot it is possible to identify its own “mass center”, together with other features belonging to the mass geometry, some of which are mentioned in the following. (Fasano, 1986)

The mass center of point masses systems is the point where it is assumed the total mass is located. If x_i and y_i are the geometrical coordinates of each point of the mass system, whose mass is m_i , and x_G and y_G are the geometrical coordinates of the mass center:

$$\begin{cases} x_G = \frac{1}{m} \sum_{i=1}^N m_i x_i \\ y_G = \frac{1}{m} \sum_{i=1}^N m_i y_i \end{cases} \quad (3)$$

where m is the total mass of the system as in equation (2).

Concerning the scatter-plot diagram, and assuming that x_i and y_i are the chromatic coordinates of the image pixels, while the total mass is represented by the total pixel number of the image, the above equation (3) can be rewritten as:

$$\begin{cases} x_G = \frac{1}{\text{pixtot}} \sum_{i=1}^{\text{pixtot}} x_i \\ y_G = \frac{1}{\text{pixtot}} \sum_{i=1}^{\text{pixtot}} y_i \end{cases} \quad (4)$$

Together with the center of mass, great relevance cover the moments of inertia. They keep into account the distribution of the masses around a rotational axis, giving a measurement of the inertia of the system with respect to changes in its rotational motion; moments of inertia are always referred to a point or an axis. When computed with respect to a point, the moment of inertia takes the name of polar moment of inertia, and it is computed such as:

$$I_0 = \frac{1}{m} \sum_{i=1}^N m_i \left\| (x_i - x_0)\hat{i} + (y_i - y_0)\hat{j} \right\|^2 \quad (5)$$

where $O = (x_0; y_0)$ is the point with respect to which the moment is computed; \hat{i} and \hat{j} are the unit vectors of the x and y axes, respectively. When computed with respect to an axis passing through $O = (x_0; y_0)$, the moment of inertia takes the name of axial moment of inertia:

$$I_0 = \frac{1}{m} \sum_{i=1}^N m_i \left\| \left[(x_i - x_0)\hat{i} + (y_i - y_0)\hat{j} \right] \times \hat{e} \right\|^2 \quad (6)$$

where \hat{e} is a unit vector parallel to the axis and the symbol \times stands for the vector product; the other symbols take the meaning as stated in equation (5).

Last, for point masses systems, a deviational moment is also defined, which is computed with respect to a couple of not-parallel planes (α and α'), whose normal unit vectors are \hat{n} and \hat{n}_0 , respectively:

$$I_{\alpha\alpha'} = -\frac{1}{m} \sum_{i=1}^N m_i \left\{ \left[(x_i - x_0)\hat{i} + (y_i - y_0)\hat{j} \right] \cdot \hat{n} \right\} \left\{ \left[(x_i - x_0)\hat{i} + (y_i - y_0)\hat{j} \right] \cdot \hat{n}_0 \right\} \quad (7)$$

Concerning the scatter plot diagram and the method we are proposing, particular interest is given to the *polar moments of inertia*, computed with respect to the center of mass; they are called *central moments* and can be computed such as in the following equation:

$$\begin{aligned} 1) \quad I_{11} &= \frac{1}{pixtot} \sum_{i=1}^{pixtot} m_i (y_i - y_G)^2 \\ 2) \quad I_{22} &= \frac{1}{pixtot} \sum_{i=1}^{pixtot} m_i (x_i - x_G)^2 \\ 3) \quad I_{12} = I_{21} &= -\frac{1}{pixtot} \sum_{i=1}^{pixtot} m_i (x_i - x_G) \cdot (y_i - y_G) \end{aligned} \quad (8)$$

where 1) and 2) represent the central moments with respect to x and y-axis, respectively, and 3) represents the deviational moment.

Once the inertia elements are known, the moments of inertia with respect to each straight line passing by O can be determined. Be \hat{e} a unit vector, whose director cosines are α and β , and r the straight line, parallel to \hat{e} and passing by O ; equation (6) can be rewritten as:

$$I_r = I'_{11} \alpha^2 + I'_{22} \beta^2 + 2I'_{12} \alpha\beta \quad (9)$$

where I'_{11} , I'_{22} and I'_{12} are the not-central moments with respect to x-axis, to y-axis and the deviational not-central moment, respectively. It is possible to find the locus of points for which I_r , the moment with respect to r , assumes the same value; this locus assumes the shape of an ellipse, which is called inertia ellipsoid with respect to point O . If substituting the not-central moments with the central moments, we obtain the equation for the central inertia ellipsoid, which is the inertia ellipsoid whose center corresponds with the mass center of the system:

$$I_{11} \alpha^2 + I_{22} \beta^2 + 2I_{12} \alpha\beta = \lambda^2 \quad (10)$$

Since

$$\hat{e} = x \cdot \hat{i} + y \cdot \hat{j} \quad (11)$$

equation (10) can be rewritten as:

$$I_{11} x^2 + I_{22} y^2 + 2I_{12} xy = \lambda^2 \quad (12)$$

The maximum axis of the inertia ellipsoid is the straight line for which the moment of inertia is minimum, while the minimum axis is the straight line for which the moment is maximum: they are called the principal axes of inertia with respect to the point O . When the inertia ellipsoid is also the central inertia ellipsoid, the minimum and maximum axes are the principal central axes of inertia, and the point O overlaps the center of mass; see Figure 4.

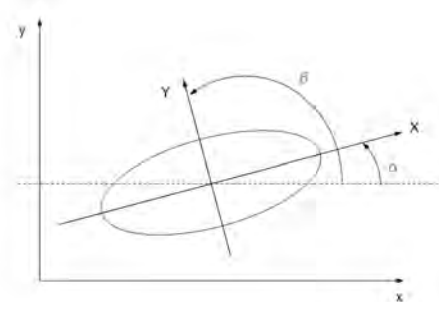

Figure 4: Inertia ellipsoid and its principal central axes of inertia X and Y.

Referring to equation (12) and to Figure 4, it is possible to infer that the inertia ellipsoid can be modelled as:

$$Y_{11} X^2 + Y_{22} Y^2 = \lambda^2 \quad (13)$$

where Y_{11} and Y_{22} are the moments of inertia referred to the axes of symmetry X and Y of the ellipse (the principal central axes of inertia).

Consider now the following symmetric matrix:

$$\sigma_G = \begin{pmatrix} I_{11} & I_{12} \\ I_{12} & I_{22} \end{pmatrix} \quad (14)$$

it is related to the Cartesian coordinate system axes for a generic point masses system. Since σ_G is symmetric, there are two eigenvalues, thus two eigenvectors corresponding to the principal central axes of inertia. Thus, in turn, the estimation of the principal central axes is reduced to the diagonalization of the matrix in (14):

$$\sigma'_G = \begin{pmatrix} Y_{11} & 0 \\ 0 & Y_{22} \end{pmatrix} = \begin{pmatrix} \lambda_1 & 0 \\ 0 & \lambda_2 \end{pmatrix} \quad (15)$$

3.3. Transplantation of colors

The method performs an automatic correction of the degraded image, on the basis of the information related to the reference image; in particular, as said, the computed inertia

ellipsoid of the original image is transformed up to overlap the inertia ellipsoid of the reference image.

First, a translation is accomplished, by referring to the center of mass of the inertia ellipsoid of the original image which is translated in the position of the one associated to the reference image; thus, being $G_D = (x_D, y_D)$ the mass center of the degraded image and $G_R = (x_R, y_R)$ the mass center of the reference one, each point of the scatter plot of the original image $P_i = (x_i, y_i)$ is moved in the position $P'_i = (x'_i, y'_i)$ such as:

$$\begin{cases} x'_i = x_i - (x_D - x_R) \\ y'_i = y_i - (y_D - y_R) \end{cases} \quad (16)$$

The second step of the correction is a rotation of the scatter plot diagram, up to the overlapping of the principal axes of inertia of the original and reference images, centred in the center of mass: being α and β the angles between the maximum and minimum principal axes with respect to the parallel of the x -axis (see Figure 4), and called γ their difference, each translated point of the scatter plot of the original image $P'_i = (x'_i, y'_i)$ is rotated up to the position $P''_i = (x''_i, y''_i)$ given by:

$$\begin{cases} \delta_i = a \tan\left(\frac{y'_i - y_R}{x'_i - x_R}\right) \\ x''_i = x_R + \left(\frac{y'_i - y_R}{\sin \delta_i}\right) \cos(\delta_i - \gamma) \\ y''_i = y_R + \left(\frac{y'_i - y_R}{\sin \delta_i}\right) \sin(\delta_i - \gamma) \end{cases} \quad (17)$$

In this way, the inertia ellipsoid of the reference and degraded image have now the same center of mass and the same directions of the principal axes, but in general they don't have the same eccentricity, i.e. the two ellipsoids have different lengths for their axes. Thus, the third step of the automatic correction aims to make the two eccentricity equal. Consider the eigenvalues of the inertia matrix of equation (15), for both the reference image and the degraded image. Being $\lambda_{\min R}$ and $\lambda_{\max R}$, and $\lambda_{\min D}$ and $\lambda_{\max D}$ the eigenvalues related to the reference and original image, respectively, the scale factors can be computed as:

$$\begin{cases} c_1 = \frac{\lambda_{\max R}}{\lambda_{\max D}} \\ c_2 = \frac{\lambda_{\min R}}{\lambda_{\min D}} \end{cases} \quad (18)$$

for a Cartesian system placed along the principal axes of the reference inertia ellipsoid; thus, the geometrical coordinates

of each translated and rotated point of the original scatter plot diagram are corrected as:

$$\begin{cases} \hat{x}_i''' = (\hat{x}_i - x_R) \cdot \sqrt{c_1} + x_R \\ \hat{y}_i''' = (\hat{y}_i - y_R) \cdot \sqrt{c_2} + y_R \end{cases} \quad (19)$$

where \hat{x}_i and \hat{y}_i are the geometrical point coordinates referred to a system whose axes are parallel to the principal axes of inertia of the inertia ellipsoid, thus resulting in the need of a double conversion, first from $(x''; y'')$ to $(\hat{x}; \hat{y})$ and, after the transformation (19), from $(\hat{x}''; \hat{y}''')$ back to the initial coordinate system $(x'''; y''')$.

Once known the corrected chromatic coordinates $(x'''; y''')$, it is possible to recover the related XYZ coordinates, such as:

$$\begin{cases} \hat{X}_i = \frac{x_i'''}{y_i'''} \cdot Y_i \\ \hat{Y}_i = Y_i \\ \hat{Z}_i = \left(\frac{1 - x_i'''}{y_i'''} - 1\right) \cdot Y_i \end{cases} \quad (20)$$

and subsequently to compute the corresponding RGB coordinates.

4. EXPERIMENTAL RESULTS

The method has been tested on some images, kindly provided by F.lli Alinari s.p.a. and coming from its archive.

Figure 5 shows a couple of images of the statue of San Giorgio, by Donatello, located in Museo Nazionale Bargello in Florence, and the result of the application of the proposed method. The left image presents a strong red toning, which is a very common damage in historical photos; the central image is a similar shot, taken at different time and view angle or position. In the right image it is possible to see how the proposed method is able to recover the original beauty of the red toned image.

In the following Figure 6, images of Ospedale degli Innocenti, SS. Annunziata square in Florence. Again, it is possible to note the strong red toning of the degraded image; it is also possible to note that the central shot has been catch nowadays, since the square has been closed to the traffic some time ago and no more cars are present. Please note the yellow car depicted in original image, whose color has been correctly recovered (as well as some other colors) even if no yellows are present in the reference image.



Figure 5: San Giorgio: in (a), the degraded image; in (b), the reference image; in (c), the result of the chromatic correction.



Figure 6: Hospital in SS. Annunziata square in Florence: in (a), the degraded image; in (b), the reference image; in (c), the result of the chromatic correction.

5. CONCLUSIONS

In this paper, an automatic chromatic correction algorithm for degraded images has been presented.

The proposed method is based on a global comparison between a degraded image and a reference image, as well as on a dualism between analytical mechanics and color theory. The reference image has the only constrain of showing contents whose colors are similar to the original image ones, if possible under similar lighting conditions. Applying some concepts coming from analytical mechanics, the inertia ellipsoid of the chromatic coordinates of the pixels belonging to the degraded images is first computed, and then transformed up to overlap the inertia ellipsoid related to the reference image, thus performing a transplantation of colors from the reference to the degraded image; furthermore, experimental results demonstrate that the correction is correctly performed even if some degraded colors are not present in the reference image.

Further improvements of the method could be in the direction of exploiting different geometrical transformations to be applied to the degraded inertia ellipsoid (see section 3 for details), to compare the performances with the proposed method.

Features of inertia ellipsoids have also to be deeply inquired, to highlight behaviours or dependences which could be profitably used in this kind of approach.

6. REFERENCES

- Martinez, K., J. Cupitt, D. Saunders, and R. Pillay, 2002, January. *Ten years of art imaging research*, Proceedings of the IEEE 90(1), 28–41.
- A. M. Bonacchi, M. Barni, A. De Rosa and V. Cappellini, *Image Segmentation and Region Filling for Virtual Restoration of Artworks*, Proc. Inter. Conf. on Image Processing 2001 1, Thessaloniki, Greece, October 2001, pp. 562-565.
- Bellone, R., 1981. *Histoire mondiale de la photographie en couleur*, Réalités, Hachette.
- Fasano, A., Rienzo, V., and Messina, A., 1986. *Corso di meccanica razionale*, Laterza, Bari.
- Field, G. G., 1988. *Color and its reproduction*, Graphic Arts Technical Foundation.
- MacAdam, D. L., 1993. *Selected papers on colorimetry-fundamentals*, Bellingham.
- Wyszecki, G. and Stiles, W. S., 1982. *Color science, concepts and methods, quantitative data and formulae*, Wiley Interscience Publication, second ed.

7. ACKNOWLEDGMENTS

This work has been supported by the Italian Ministry of Education as a part of the FIRB project no.RBNE039LLC, “A knowledge-based model for digital restoration and enhancement of images concerning archaeological and monumental heritage of the Mediterranean coast”. The authors also thank F.lli Alinari SpA (www.alinari.com) for providing the pictures for the tests.

PHYSICS AND CHEMISTRY APPLIED TO THE VIRTUAL RESTORATION OF PAINTINGS

A. Zymla^a, P. Callet^a, S. Dumazet^a, Z. Sarol^b, B. Moreno Maso^b

^a Ecole Centrale Paris, LGPM, MAS, grande voie des vignes, 92290 Châtenay Malabry, France
(anna.zymla, patrick.callet, sylvain.dumazet)@ecp.fr

^b Centro Nacional de Conservación, Restauración y Museología, La Habana, Republic of Cuba
bienesmuebles@cencrem.cult.cu, contracorriente@cubarte.cult.cu

KEY WORDS: Gilding ; Spectrophotometry ; Chemical analysis; Colorimetry ; Art history ; Virtual restoration ; Painting ; SEM

ABSTRACT:

Physics, chemistry, optics and computer sciences are cooperating for a virtual restoration project concerning a cuban painting, deposited for restoration at the CENCREM in La Habana. The studied painting is a work of José Nicolás de la Escalera y Domínguez (1734-1804) and situated inside the Santa María del Rosario church. The work is important from several points of view and, among all is the symbolic content. The painting "La Rosaleda de Nuestra Señora" probably includes the first representation of a black man converted to christianism. Situated on the four corners of a byzantine church style, the "Pechinas" are triangular lin canvas made of 3 pieces of web. We studied using spectrophotometry for identification of the painting materials (without contact) and made some micro-analyses mainly concerning the gilded peripheral regions of the painting. That last part of the work in progress is presented and gives access to paint layers composition from the canvas to the varnish. The painting was executed on a general brownish now identified underlayer though only a black man is represented among all other ecclesiastical white figures. Thus the artist decided to give a general dominant color to the whole composition. A very high technical mastery is quite evident for the gilding process used by the artist. With many several analyses we will be able to help restorers and art historians by digital, spectral and simulation tools.

1. INTRODUCTION AND HISTORICAL CONTEXT

The presented work is still under scientific and technological developments, placed in the framework of a partnership between two french academic laboratories and the Centro Nacional de Conservación, Restauración y Museología, La Habana, Republic of Cuba. Deposited for a restoration campaign of some major painted works, we participated in spectrophotometric measurements and chemical analyses of some fragments. The studied painting is presented in Figure 1. Among the four paintings placed at the vault corners of the byzantine church Santa María del Rosario, the painting "La Rosaleda de Nuestra Señora" probably includes the first representation of a black man converted to christianism. The symbolic importance of that work leads to specific scientific studies. We describe the processes of materials analysis and give some model elements for a virtual restoration of the gilding ornaments. There are not enough studies on virtual restoration based upon pigments composition. For real time rendering, GPU based algorithms are potentially connected to physical properties of the paint layers (Pitzalis, 2008). Many works mainly concern image analysis for color correction. Varnish restoration has recently been applied to the most famous painting of Leonardo da Vinci (Elias, 2008) and defines a very promising method based upon pigments and paint layers analyses with optical sensors. We have previously led many experiments for characterizing the real influence of the substrate coloured paint, called gold-size, on the global visual appearance of several gilded surfaces (Dumazet, 2007). Many works of art are covered by a gold film deposited by different processes. Among these are mercury gilding and gold-leaf gilding. The substrate colour is generally depending on the material in which the work of art is made. The reasons are found in the mechanical properties needed for fixing the noble metal on the material support. We have studied gilded sculptures or ornaments used in architecture and presented the complete scientific chain of treatment for a virtual or real restoration.

Gilded brasses obtained by mercury gilding and their corrosion influence was shown thanks to scanning electron microscope (SEM). For metallic sculptures when made of gilded brasses for example, a very thin crack in the gold-leaf causes the corrosion process to start and to recover an important part of the object. The optical appearance of such a gilded surface is then deeply modified. Similar ideas have been applied for understanding the visual appearance of the gilded parts of the painted works of José Nicolás de la Escalera y Domínguez. We attempt to render with an original algorithm (Dumazet, 2007) the visual appearance of gildings based upon their composition and the background colored preparation called bole.

2. MATERIALS IDENTIFICATION

The materials identification was approached in two different, but nevertheless classical ways today. A first attempt for characterizing the painting materials was spectrophotometry. That is a non invasive technology using (non-laser) white light. Thanks to a portable spectrophotometer, used in backscattering mode, the diffuse reflectance factors were recorded for several colored regions chosen over the whole surface of the painting. We were interested in comparing the general tone rendering of the work with the specific rendering of the black man skin. Micro analyses by SEM and Optical images identification were also made and gave the elementary composition of the analyzed samples. The greatest attention was brought to gildings and their optical properties useful for rendering.



Figure 1: The painting "La Rosaleta de Nuestra Señora" includes the first most probable representation of a black man converted to christianism. Painted by José Nicolás de la Escalera y Domínguez (1734-1804) and situated inside the Santa María del Rosario church, the work is important from several points of view and, among all is the symbolic content. The image shows the gilded remains studied in the bottom part of the image.

2.1 Spectrophotometric Measurements

Many spectrophotometric measurements were made in several regions of the painting. The chromatic palette used by the artist is however very restricted. Figure 2 exhibits the normalized results of the diffuse reflectance factors concerning the black man skin. The today grey paint could have been a «real» white paint. The general visual impression in viewing the painting is that of a greyness and brownish covered surface. A bluish brown is also observable and correspond to a prussian blue deposited on the brown background. It is probably not a mixing of iron oxide pigments with prussian blue pigments. The discrimination between the two involved phenomena of color appearance: a thin film of paint deposited over a uniform colored background and a mixing of the two kind of pigments, is not possible by spectrophotometric measurements.

Though the spectral curves in figures 2 or 3 are difficult to read, due to the adopted normalization, the differences between the optical properties of the materials are magnified.

2.2 Chemical analyses

SEM images give information about the material structure of the pigments layers. The small scales extracted from the gilded region of the painting are embedded in a resin, according to specific recommendations. Two orthogonal sections were made on these samples for qualitative and quantitative analyses. We summarize the results in the next subsections.

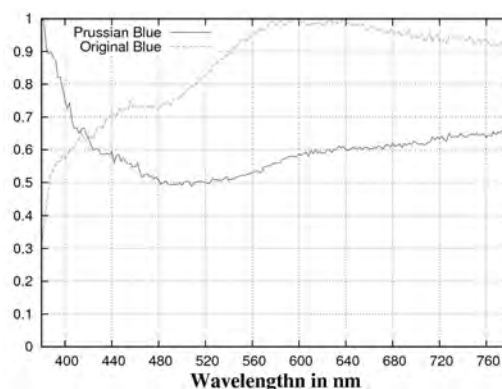

Figure 2 : Spectrophotometric measurements taken on the forehead skin of the black man and compared to the underlayer paint. The top curve shows the grey paint used for clothes.

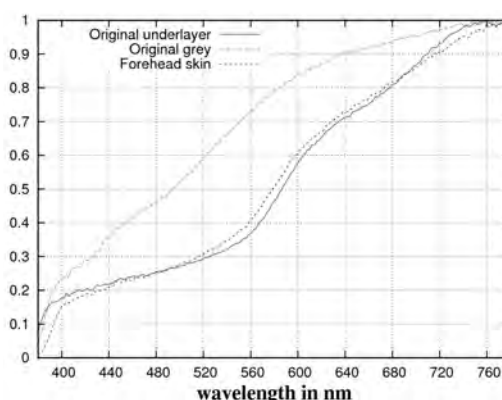

Figure 3: Comparison of two normalized spectrophotometric measurements made on the bluish regions. The normalized diffuse reflectance factors show the background influence on the paint appearance. The blue pigments were deposited on the brownish colored preparation. All the colors of the work are influenced by this colored underlayer. Top curve: original blue.

Colored preparation: The painting under layer seems to be covering the whole surface of the canvas. The general given brownish coloration has a quite visible influence on all the superimposed pigment layers. The painter wanted to render a special atmosphere where warm colors were omnipresent. The white reference that our eyes are looking for in examining such a work is then defined by the lightest region. Though that is a general property of the human visual and cognitive system, it appears here as an artist will.

In the appendix, Figures A1 and A2, one can see the results of the observations made on a physical sample extracted in the peripheral gilded region of the painting. Two layers of materials are observable under the top gold leaf.

Thus one can find from the deeper part to the surface :

- thickness $\sim 50 \mu\text{m}$. Cerusite PbCO_3 , which is the most common white lead, with very small particles of silica SiO_2 and iron oxide aluminosilicates. Some inclusions of gypsum CaSO_4 . Here is probably used the red ochre silica sand and not an extracted ochre pigment.
- Thickness $\sim 200 \mu\text{m}$. Cerusite PbCO_3 mixed with Calcium carbonate CaCO_3 and larger particles of Baryte BaSO_4 , silica SiO_2 , iron oxide aluminosilicates (Fe_2O_3). This is typically a cheaper layer attested by the presence of chalk.

Bole composition: A detailed presentation of the bole composition is given in Figure A4 while the measurements points are given in Figure 3.

Inside the deeper part of the bole, one can summarize, at about 200 - 300 μ m from the gold leaf, the supposed composition:

- Greyish particles of Hematite Fe₂O₃ (Spectra 2, 6 and 9)
- Reddish mixing of baryte BaSO₄ with hematite Fe₂O₃ powder (Spectra 7 and 11) and (Mg,Ca)CO₃ (Spectrum 4)
- Fine reddish mixing of Fe₂O₃, BaSO₄ and cerusite PbCO₃ (Spectra 8 and 10).
- Spectra 3 show 5 indicate the presence of resin penetrating the preparation

Gilding and lighting: It is generally observed that the colored preparation used for gilding is mainly reddish for wood or stone polychrome sculptures. This is particularly true in Europe at least at the medieval epoch and, more obviously, later (Renaissance). Mainly red ochre (iron oxide) is employed and in the specific painting here studied a small amount of blue pigments were introduced. That last addition gives the bole a brownish appearance. This is reinforced by lighting with wax candles or oil lamps having an important emission spectrum in the yellow-red-IR region of the visible spectrum.

In these lighting conditions the painting could appear with a more yellow gold for the peripheral ornaments, than it would appear today. The inter-reflections of light inside the church itself also brought a special ambient coloration. That last observation involves a color appearance model to be used for an enhanced rendering (Fairchild, 2005). Probably the most important works having led for accounting the surrounding influence on color perception (Gilchrist, 1994) in computer simulated images will be included in the future models.

In Table A1 the gold leaf as typical composition of gold with very small amount of copper and silver. It could be considered as a pure gold employed at this time.

We have previously shown (Dumazet, 2007) the influence of small cracks and holes in gold leaf on the visual appearance. A statistical approach used in the analysis of the geometrical profiles of the surface gold leaf led to a physical model hereafter described in Figure 4. See the above reference for more details on the calculations.

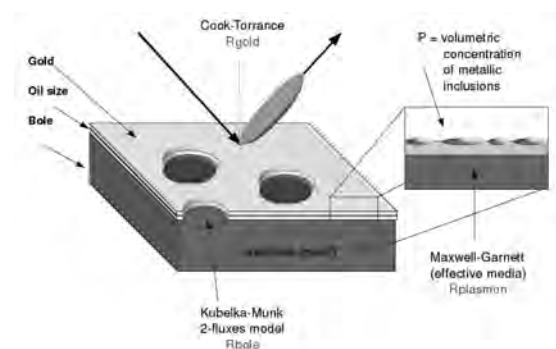

Figure 4: The physical description of the optical interactions accounted for the rendering of a gold leaf deposited on a colored bole. Small cracks due to the application process and the natural holes in thin metallic films are described. Their surfacic density creates a diffuse contribution to the reflected light.

3. RENDERING IN SPECTRAL RAY-TRACING

We used the opensource spectral ray-tracing software Virtuelium to render the images below. The very simple 3D scene in Figure 5 is computed with 2 kinds of illuminants. A normalized CIE D65 and a measured emission spectrum of a wax candle. Obviously the lighting conditions create a very tiny visible difference between the images computed for the wax candle light. In a simulated daylight with CIE D65 illuminant the differences are more visible because the incident light is enriched in the blue region of the spectrum. The colorimetric reference observer is defined as CIE 1964 10°. All the computations are made on the visible spectrum sampled à 5nm in wavelength.

4. CONCLUSION

The study here presented constitutes a second step in making virtual tools formulation for restoration of paintings and gildings. We have still to account for the lighting conditions of the real building where a painting was historically dedicated. Not only the material composition of the paint layers, each of their own thickness are required for a good visual appearance restitution. The symbolic significations and the general ambiance wanted by the artist have to be combined with the knowledge of the lightings either natural or anthropogenic. The work must continue for including parameters depending on historical and architectural reconstructions, physics and chemistry of materials and their lighting. This work is naturally pluridisciplinary.

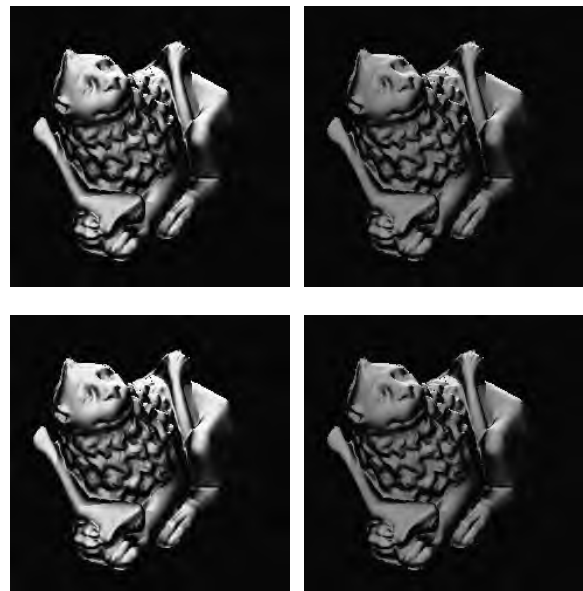

Figure 5: Influence of the colored bole and lighting conditions on the visual appearance of a gilded object. Top images are computed for a cinnabar bole while bottom images are computed for the present studied brownish bole. The illuminants are CIE D65 for column left and a wax candle for column right. For all images there are 12 per cent surfacic holes and cracks in the gold leaf.

5. REFERENCES

- Elias, M., Cotte, P., 2008. Multispectral camera and radiative transfer equation used to depict Leonardo's sfumato in *Mona Lisa*, . *Applied Optics*, 47(12), pp. 2146-2154.
- Pitzalis, D., Colantoni, P., Pillay, R., Aitken, G., 2008. A Tool for Enhanced Colorimetric Perspective of Cultural Heritage, *Proceedings of the 3rd International Conference on Computer Graphics Theory and Applications GRAPP 2008*, Madeira, Portugal, pp. 492-496.
- Dumazet, S., Callet, P., Genty, A., 2008. Virtual restoration of a medieval polychrome sculpture- Experimentation, Modelization, Validation and Visualization in Spectral Ray-tracing, EG-Springer, *Proceedings of the 3rd International Conference on Computer Graphics Theory and Applications GRAPP 2008*, Madeira, Portugal, 2008, pp. 463-470.
- Dumazet, S., Genty, A., Zyma, A., de Contencin, F-X., A. Texier, A., Ruscassier, N., Bonnet, B., Callet, P., 2007. Influence of the substrate colour on the Visual Appearance of Gilded Sculptures --Materials Studies to Spectral Simulation and Restoration--. *Proceedings of the CIPA symposium*, Athens
- Arend, L., 1994. Surface Colors, Illumination, and Surface Geometry: Intrinsic-Image Models of Human Color Perception. In A. Gilchrist (Ed.), *Lightness, Brightness, and Transparency*. Hillsdale:Erlbaum, pp. 159-213.
- Fairchild, M. D., 2005, *Color Appearance Models, 2nd Ed.*, Wiley-IS&T, Chichester, UK
- Gilchrist, A. L., and Cataliotti, J., 1994. Anchoring of surface lightness and multiple illumination levels. *Investigative Ophthalmology and Vision Science* (supplement), 35(4), p. 2165.

APPENDIX A

Results of SEM and Optical images analyses

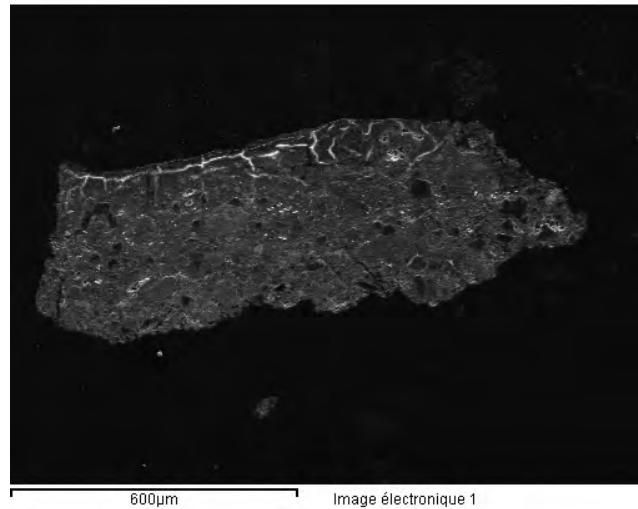

Figure A1: SEM image of a vertical cross section made on a small scale taken in the gilded bottom region.

Bole characteristics from the SEM image red zone in Figure A1.	
Layer 1	Au thickness < 1µm including small amount of Cu and Ag
Layer 2	Cerussite $PbCO_3$ with very small particles of SiO_2 and iron oxide aluminosilicates. Including gypsum $CaSO_4$
Layer 3	Cerussite $PbCO_3$ mixed with Calcium carbonate $CaCO_3$ and larger grains of Baryte $BaSO_4$, silica SiO_2 , iron oxide aluminosilicates (Fe_2O_3)

Table A1: Bole characteristics

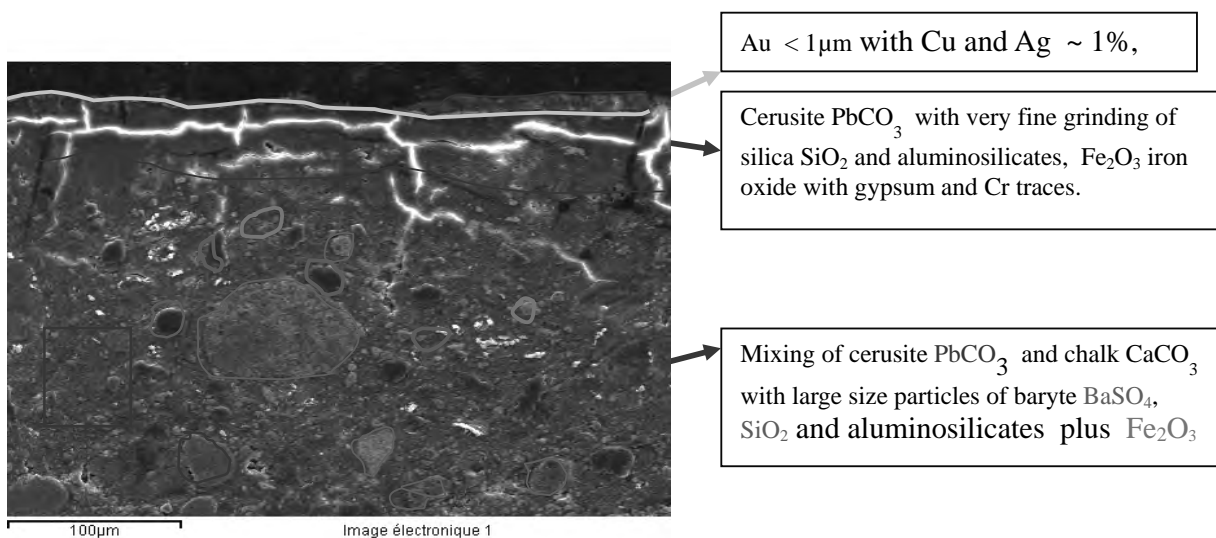

Figure A2: SEM image of a cross section exhibiting the measurements regions studied for identification near the gold leaf. Notice that the elementary composition extracted is not an absolute indication of the real composition, only the most plausible.

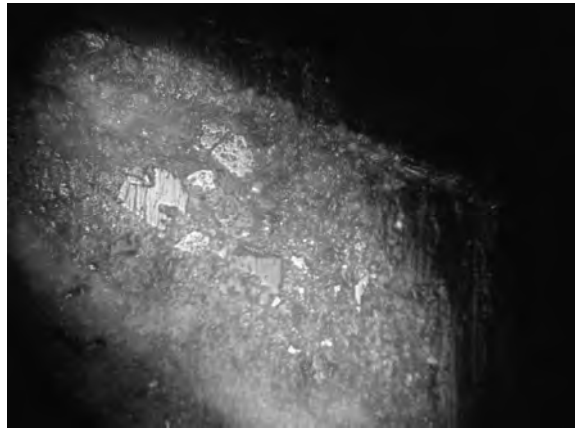

Figure A3: Optical image of a vertical cross section.

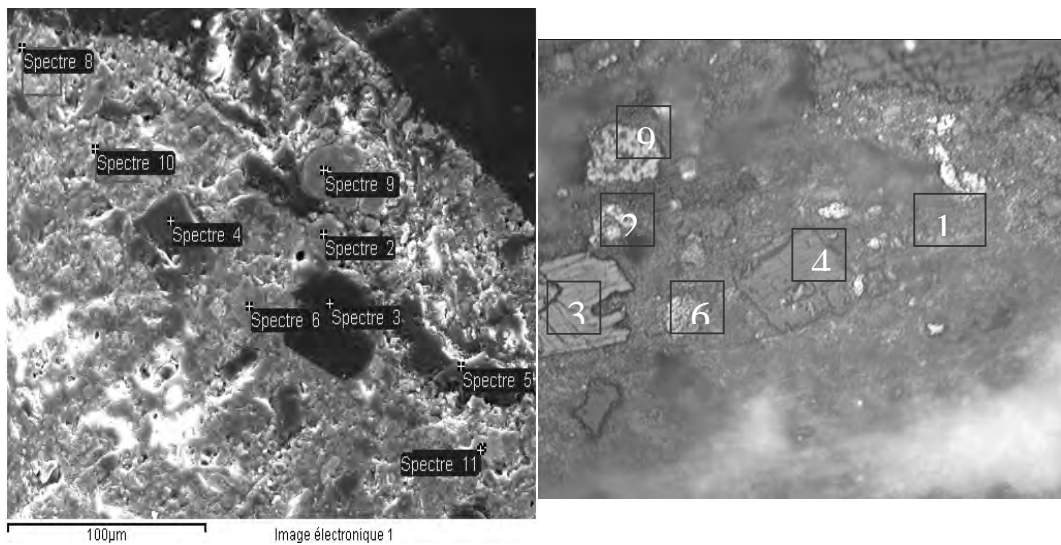

Figure A4: SEM image (left) indicating the identification points where the spectra were recorded. The right optical image is a vertically symmetrical view of the SEM image.

Spectrum	C	O	Mg	Al	Si	S	Cl	Ca	Fe	Ba	Pb
Spectrum 2	8.2	35.07		0.5	1.1				52.21	1.1	2
Spectrum 3	86.2	12.8				0.2		0.2	0.5		
Spectrum 4	11.8	55.7	15.2					17	0.4		
Spectrum 5	68.2	27.1					0.7		0.25		3.8
Spectrum 6	9.7	35.7		0.5	1.2		0.3		49.35		3.3
Spectrum 7	8.6	32.7				12.2			1.14	43	
Spectrum 8	22	33.4		1.0	2.02	3			18.0	13.8	6.9
Spectrum 9	9.7	36.5		0.5	1.4				50.5		1.4
Spectrum 10	25.2	37		1.3	3.8	0.13			21.6	2.9	8.2
Spectrum 11	8.2	34.7		0.4		12			1.6	41.5	

Figure A5: The elementary composition of the 11 regions studied from which a plausible paint composition can be proposed.

PREPARING DARIAH

Panos Constantopoulos^a, Costis Dallas^a, Peter Doorn^d, Dimitris Gavrilis^a, Andreas Gros^c, Georgios Stylianou^d

^a Digital Curation Unit, Athena Research Centre, Greece - (p.constantopoulos, c.dallas, d.gavrilis)@dcu.gr

^b Computer Graphics and Visualization lab, European University, Cyprus – g.stylianou@euc.ac.cy

^c Max Planck Digital Library (MPDL), Munich, Germany – gros@mpdl.mpg.de

^d Data Archiving and Networked Services, The Hague, The Netherlands - Peter.Doorn@dans.knaw.nl

KEY WORDS: Arts, Humanities, e-infrastructure

ABSTRACT:

In this paper, a preparatory project for an integrated European research infrastructure in the humanities is presented. This project, *Preparing for the construction of the Digital Research Infrastructure for the Arts and Humanities - or Preparing DARIAH for short*, is part of the ESFRI e-infrastructures programme and supports the emergence of a new collaborative framework in which researchers are able to maximise the impact of their work on the international stage and aims at providing the foundations for the timely construction of the infrastructure requisite for the arts, humanities and cultural heritage communities in the digital age. DARIAH uses an interdisciplinary approach and involves tackling a number of interrelated issues such as strategic, organisational, financial, technical and conceptual in order to facilitate long-term access to and use of all European humanities and cultural heritage information for the purposes of enhancing and expanding research, thereby increasing our knowledge and understanding of our histories, heritage, languages and cultures. The DARIAH network will act as a place where the incubation of new ideas and ways of working can be facilitated and developed, and then transitioned into established organisations thus ensuring long-term sustainability and stability and the integration of these methods and techniques into everyday research practice. DARIAH will support research practitioners at all stages in the research process, and at differing levels of sophistication, from beginners through to those employing advanced techniques and methodologies.

1. INTRODUCTION

The project, *Preparing for the construction of the Digital Research Infrastructure for the Arts and Humanities - or Preparing DARIAH for short*, aims at providing the foundations for the timely construction of the infrastructure requisite for the arts, humanities and cultural heritage communities in the digital age. The 'grand vision' for the DARIAH Research Infrastructure is to ensure the long-term availability and access to the cultural heritage related information along all European partners followed by its augmentation and expansion. It's long term benefits include the enhancement of existing knowledge, research expansion and the better understanding of our heritage, history, languages and culture. This vision is characterised by innovation: new ideas and ways of working will be incubated, facilitated, developed and turned into established organizations. DARIAH will make the integration of these new ideas and practises into everyday life easier and will also support researchers in all stages in the research process and at different levels of sophistication, from simple to more advanced techniques and methodologies.

The organization structure will consist of a central office based on one or more of the partners. The central office will act as a coordinator of the network. DARIAH intends to be inclusive and will welcome new partners who wish to contribute and learn. The guiding principle behind DARIAH is the bringing together of the different stakeholders into a federated knowledge network: digital archives, libraries, data centres, research practitioners, research groups, technologists, computer and information scientists and other supporting services such as legal and advisory services. This mix of all these stakeholders exists already.

2. VISION AND IMPACT OF DARIAH

Preparing DARIAH aims at preparing for the construction of DARIAH by 2010. This preparatory phase will address coordination, strategic, financial, governance, logistic, legal and technical issues. The project will deliver the following:

1. a business plan for the construction and operation of DARIAH
2. a consortium that will be committed to the construction and operation of DARIAH
3. all legal documents regarding the rights and obligations of DARIAH partners, allowing the inclusion of new partners.
4. financial support capable of sustaining the initial development and operation of DARIAH

DARIAH will make researchers aware of the data available in the EU community and provide them with the means to locate and access this data. Research practice in the arts and humanities is often about meaning, interpretation and re-interpretation. This meaning is usually extracted from the data available from a wide range of primary and secondary sources. DARIAH intends to exploit the widespread broadband connectivity and the power of the web-based tools available for the analysis of digital information in order to provide support for the changing nature of the research practice in the arts and humanities. With the proper knowledge creation and information sharing, scholars will be able to explore vast amounts of information, answer new questions and perform their work more efficiently.

3. DESCRIPTION OF DARIAH

3.1 Strategic work and coordination

In order to ensure project viability, DARIAH must first identify its goals and objectives so that to ensure maximum impact. A clear and comprehensive view of the state of the art must be provided during the strategic work development. This work will provide an insight on the needs (data and tools) from users across Europe with emphasis on the partner countries. Products and services already provided by data organizations situated in partner countries will be identified and be included in the technological architecture. Finally, the subset of standards currently used in the arts and humanities in Europe will be identified.

Although DARIAH starts with a core of partners and data providers, aims to expand to include partners from all Europe thus increasing its power as each partner joins the infrastructure. As a consequence, investigation must be carried out among the various EU member states in order to identify potential partners, organizations, material owners, researchers. A user requirement analysis must also be carried out especially because in DARIAH one can find many user communities (archaeology, history, classics and arts) with possibly different requirements. Based on the above studies, a non-technical standards framework will be created that will encompass the services that should be included in the technical framework. In this phase, a set of policies will also be developed for the following areas:

- Digitization
- Collection development
- Collection ingestion and management
- Preservation
- Compliance as a trusted digital repository

3.2 Financial work

To be able to provide long-term services to the European research community in the humanities, a sustainable business model for DARIAH has to be defined. The business model also has to ensure the project's adaptability to new partners' needs. Furthermore, it has to be based on a cost model that captures fixed costs, e.g. for core personnel, as well as variable costs related to services offered to individual scientists, research communities or wider national and international projects. Based on the cost model a corresponding funding scheme has to be developed. One crucial part of establishing the funding scheme will be to gain support from national funding agencies for services used by national research projects. Therefore, several national funding agencies will be included into the process of formulating a funding model from the very beginning. In addition, participating institutions support DARIAH through their own data centres. Furthermore, as soon as DARIAH can offer services and support to third-party institutions, partnership services can be included into the business model.

A well-designed business model will attract new partners and stakeholders (research institutions, universities, cultural heritage sector, publishers, funding agencies, government agencies and the European Commission).

Related to the financial work is also the preparation of exit strategies for long-term preservation of data in case the DARIAH infrastructure comes to an end. Such strategies have

to be defined in close collaboration with cultural heritage institutions such as national libraries and archives.

3.3 Legal work

The exchange of cultural heritage data among many partners in different countries requires agreements that will lay down the rights and obligations of each partner.

Some of the legal issues that will be addressed by DARIAH are: data depositing, data preservation, data dissemination, and corresponding products and services to be provided.

Legal work is of major importance since DARIAH is inherently heterogeneous. Firstly, the partners are from different countries with different legislations. Secondly, the addressed organizations are different, e.g. universities, companies, public sector, and, thirdly, the distributed repositories hold data with different classification status, e.g. publicly available, partially available, or commercial.

An analysis of EU legislation – mostly regarding intellectual property rights and privacy regulations – must be carried out along with relevant EU directives concerning preservation and access to data. Special attention will be paid to the Open Access Movement on data and publications. Guidelines, like the UNESCO Charter on the Preservation of the Digital Heritage, will also be considered.

Among the deliverables for DARIAH are a consortium agreement, an accession form for future partners, a depositor licence agreement, and a draft user licence agreement for products and services.

3.4 Technological reference and architecture

A robust technological architecture will act as a technical reference and will be used in the proof of concept prototypes. This architecture will take into consideration the distributed and heterogeneous nature of DARIAH. More specifically, it will:

- Embed existing centres
- Leverage the creation of new centres.

Because of the enormous amounts of data that are available, the technological framework will adopt grid-based solutions mainly for the storage of the digital content. The technological architecture will consist of the following layers:

1. Basic infrastructure: This layer will be designed so as to provide virtual infrastructure for data storage, support single sign-on services and manage the distributed repositories within this virtual layer.
2. Virtual repository layer: This layer addresses the highly diverse and complex data in the arts and humanities by allowing for seamless access for users and additional services through the use of repositories.
3. Interoperability layer: This layer implements the standards and guidelines that will act as a “semantic glue” between the different repositories and will allow to link their contents together.
4. Service layer: This layer provides tools that will interface with the DARIAH archive and/or other tools. Users will be able to “plug” their own tools and thus expand DARIAH services by creating new services or by augmenting existing ones through an open and flexible SOA architecture.

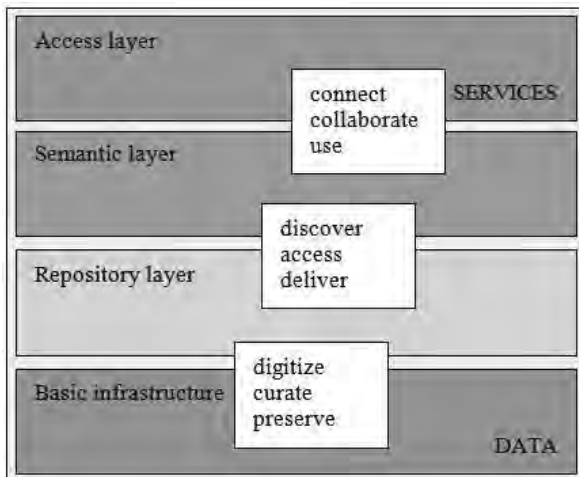

Figure 1: DARIAH technical layers

The technological infrastructure of DARIAH will be a service oriented architecture (SOA) and will be based on the Fedora repository architecture. It will adopt technologies like SOAP and REST, it will make data available for PMH harvesters and ontologies will be employed to make these data interoperable across different data centres. The adoption of an open architecture is imperative since in the virtual repository layer, there exist providers with a plethora of repositories such as Fedora, eSciDoc, EASY and other national repository systems. The proposed architecture must be able to virtually link all these repositories together. The big advantage of a SOA architecture is that users can implement their own services as modules that can be used to expand the available services. This approach will ensure that new partners will be free to implement their own ideas into the DARIAH architecture. Furthermore, one can combine these services by building higher level services on top of existing ones thus expanding the available services exponentially.

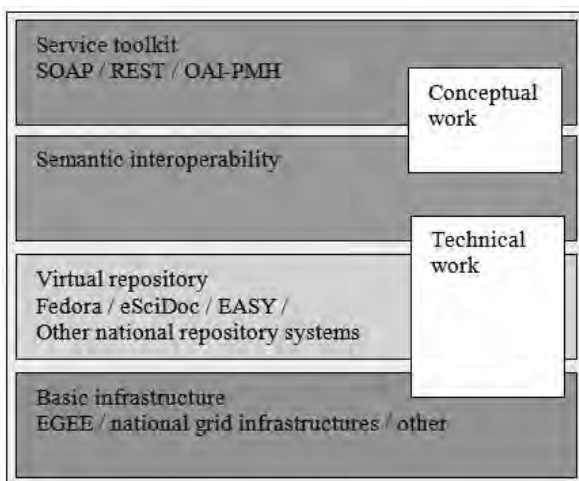

Figure 2: Architecture of the proposed DARIAH prototype

3.5 Conceptual modelling

Research in the arts and humanities is characterized by meaning extraction from often incomplete or “fuzzy” datasets. The

interpretation and re-interpretation of the results constantly changes not only when new data is available but also when hypotheses change. Thus, this research practice is characterized by constant change. In order to design a system that will ease this process, data must be semantically annotated in such a way that researchers can extract knowledge more easily. This requires a mechanism for semantic annotation of the data along with an interoperability layer that will link different datasets together since they are distributed throughout Europe.

In order to provide a high quality interoperability layer that will allow a coherent virtual integration among the various repositories, an interoperability framework must be proposed that will act as a common reference across the various DARIAH members. Because of the diversity of formats and different metadata standards found in the arts and humanities, the need arises for linking those formats together and/or proposing new common standards for newly created data centres.

Conceptual modelling is especially important and complicated in the arts and humanities because knowledge is created through hypotheses that are based on facts and other hypotheses that constantly change. Thus, a proper knowledge representation is required to both preserve knowledge and aid researchers in their work.

The goals of the conceptual modelling will be three-fold:

- identify the different processes among the various scientific domains and map them to the existing data centres;
- assess digital assets at the various data centres and establish recommendations on their representation; and
- evaluate the process and object models bearing in mind the heterogeneous environment and the various user groups / scientific domains.

A robust and well-designed semantic layer will help better connect the different data centres within a common metadata framework. The use of mappings between metadata schemas will also be explored in order to enhance the work of harvesters. Furthermore, semantics will help address the issue of intellectual content preservation in addition to bitstream data preservation - a major problem in the area of the arts and humanities.

4. CONCLUSIONS

In conclusion, DARIAH is building a multinational research infrastructure for the arts and humanities intended to support researchers from all European countries. As more countries join DARIAH, more data and more tools will be available thus increasing its value. According to the current schedule, DARIAH will be ready for construction by 2010 (that is when the preparatory stage ends). By that time, new technology, data and human (partners) infrastructure will be ready.

5. REFERENCES

References from websites:

<http://www.dariah.eu>

THE PALAZZO DELLA RAGIONE IN PADUA: REPRESENTATION AND COMMUNICATION OF ART, ARCHITECTURE AND ASTROLOGY OF A CIVIC MONUMENT

M. Borgherini^{a, *}, E. Garbin^a

^a Università IUAV di Venezia, DPA Dorsoduro 2196, 30123 Venezia borgheri@iuav.it, egarbin@iuav.it

KEY WORDS: 3D Modelling, Interface Design, e-Museums, e-Ehhibitions

ABSTRACT:

Eight centuries of the history of art and of Padua's scientific and technological culture deposited on the stones and frescoes of its Palace of Law (Palazzo della Ragione) make this great work of urban architecture a part of the city's collective identity. This «palimpsest», legible only to a restricted circle of specialists, should be accessible to a vaster public interested in understanding this object symbol of local culture. The project planned for interactive exploration on the web is a series of digital models, employing tomographic-endoscopic visualizations and, in future, multiresolution images. The various models devised allow the visitor to superimpose the Palace's current conditions on the various transformations undergone over the centuries. Similarly, comparisons can be made between the astrological fresco cycle with maps of the heavens, cosmological hypotheses, ancient and contemporary astrological treatises, and the related exchange of knowledge between the Orient and the Occident.

1. INTRODUCTION

1.1 Motivation of the project

The series of modifications that have ensued upon the structure and skin of civic monuments over the course of centuries, often acquire such a stratification of values, meanings, and connections to their context to make large urban architectural works the constituent elements of the collective identity. A «stratified» analysis of these buildings is necessary for both specialists working in the field of building research, protection, and reutilization, as well as for the larger part of occasional visitors who are intent on understanding a symbolic object of local culture.

This work involves a representational and communicative theme for which no real satisfying solutions have yet been found, neither through traditional means, nor with digital technology. A series of thematized graphic elaborations, as detailed and articulated as they are formally and historically complex, can represent, analytically and diachronically, a quantity of data that should also be read, compared, and sighted synthetically.

Today we can imagine more appropriate representational and communicative strategies for presenting in a concise and synchronous manner the complexity of meanings and connections. Strategies that use new forms of inquiry, narration, and exploratory methods capable of dynamically spanning the layers and steps of representation through the use of ever more agile perceptive and interpretive skills – skills which are unfortunately ignored by professionals in the field of communication of the arts and which have been developed in most urban populations by television and other networks.

To activate such strategies, in our opinion, requires a multiplicity of knowledge and know-how spanning the fields of history and criticism (e.g., recognizing and interpreting the different documental «layers» of a building by the use of hierarchical mapping so as to place the building in its cultural context and to understand the antecedent factors that generated it), as well

as matters more strictly representative in nature, and finally cognitive-semantic issues pertaining to the use of the most adequate codes for transmitting complex artistic, scientific, and architectural works.

1.2 Choice of the subject and aim and the project

The work we present (the project team, directed by Malvina Borgherini and Emanuele Garbin, is composed by Luciano Comacchio, Rita El Asmar, Margherita Marrulli, Marco Mason, Eufemia Piizzi and Silvia Spinelli) is a representational and communicative project involving the urban monument of Palazzo della Ragione in Padua. We have elaborated specific solutions in hope that they will be reutilized as prototypes for other buildings and contexts. The reason for choosing a medieval civic structure such as that of Palazzo della Ragione was based on various factors:

- the diversity of works contained within the building (i.e., the cycle of astrological frescoes, the court insignia, the monuments of illustrious city figures, the units of measurement used for commerce and trade);
- the variety of spaces subsequently modified and/or constructed over the course of centuries, in response to the changing needs of the two principle activities – judiciary and commercial – carried out in and around the building;
- the considerable quantity of documents directly or indirectly related to the palace (the astrario, a planetary clock used for compiling horoscopes, built by Giovanni Dondi; various astronomical-astrological manuscripts from the Padua area and their antecedents; the cycles of Paduan frescoes dating from before and after the cycle of astrological frescoes; documents related to judiciary activities conducted in the building until the end of the 18th century);
- and last but not least, the continual maintenance of the ground floor market for the past eight centuries that has kept this urban monument still active today. While the cessation of judiciary activities on the upper floor contributed to the loss of meaning associated with the astrological frescoes.

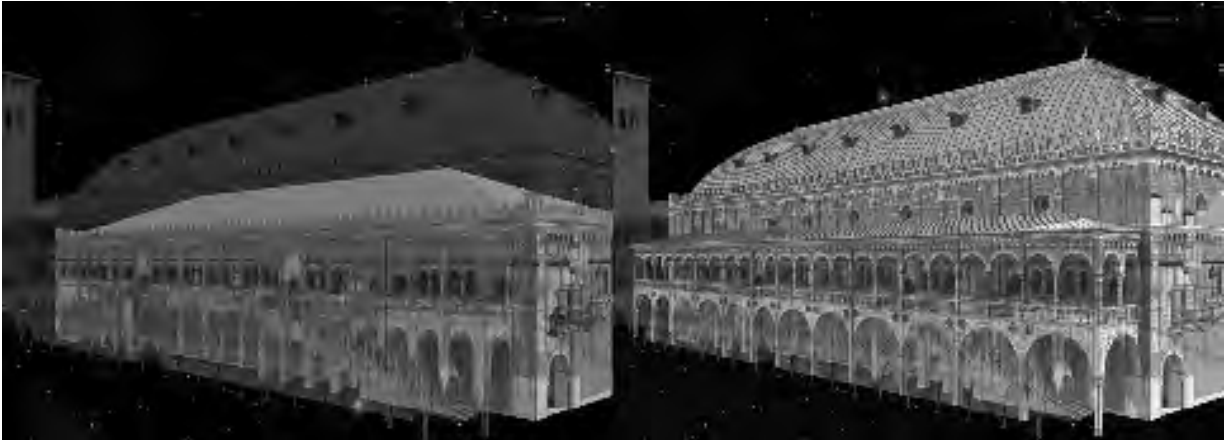

Figure 1: Analysis of the historical phases

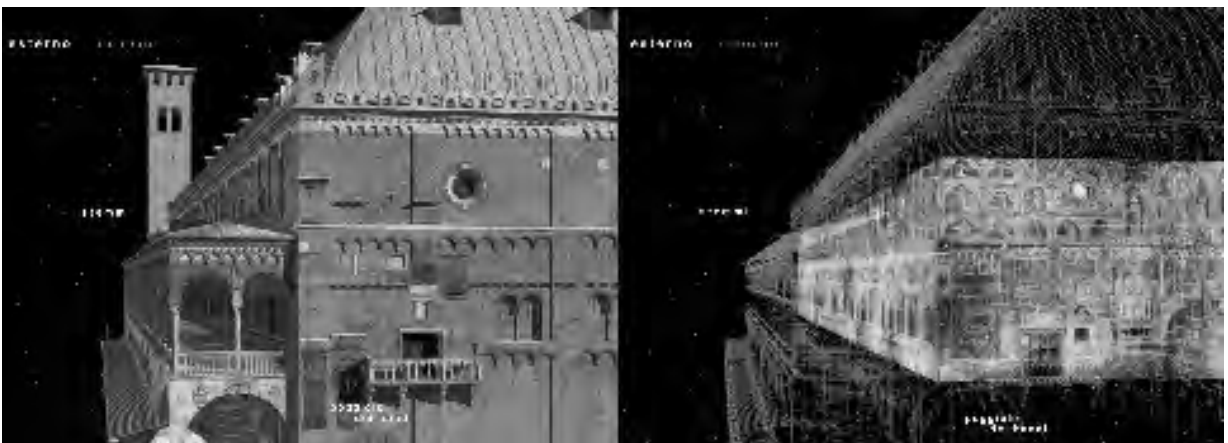

Figure 2: External view of the building in non-transparent mode



Figure 3: Analysis of the historical phases

The driving force for initiating this representational and communicative project has been the idea of making such a significant structure to our cultural identity recognizable to a greater public, as well as the forthcoming conclusion of a long interdisciplinary project of analysis, research, and restoration on the building. The project, together with the scientific publication of the results from the completed work on the palace, addresses a vast public of non-experts via the web.

2. THE PROJECT

2.1 Innovative features

The main novelty of this project consists in the fact that it allows users to select and read figurative and alphanumeric data (the latter in the form of dynamic text containing no more than four or five lines each) that is as free from our customary habits as possible – those habits which are dictated by our daily use of graphic interfaces in computer operating systems. It is the same



Figure 4 Analysis of the historical phases



Figure 5: Astrario model, instrument designed by Giovanni Dondi

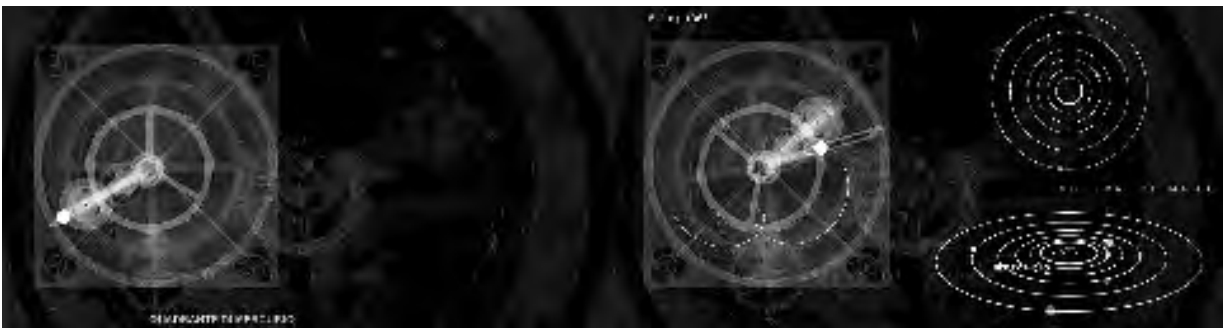

Figure 6: Astrario model, instrument designed by Giovanni Dondi



Figure 7: Saturn section: thematic details regarding the zodiac, the precession of the equinoxes, and the construction of a horoscope

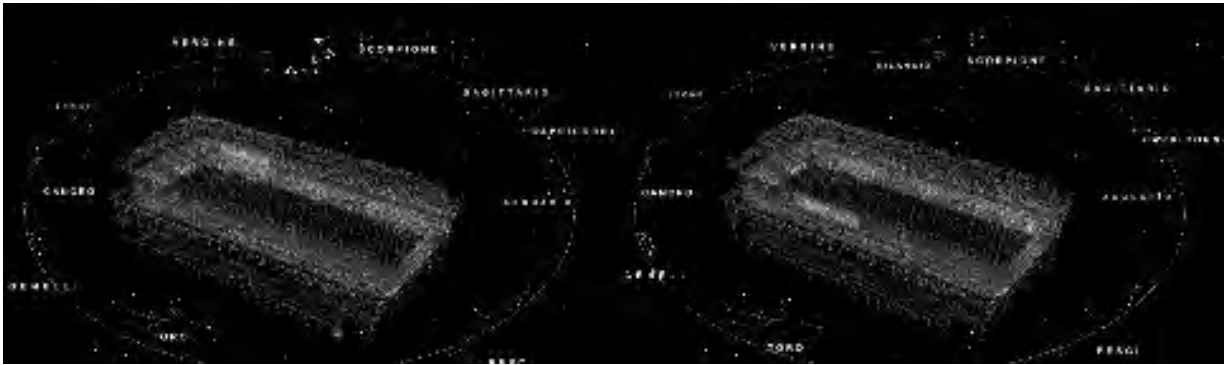

Figure 8: Relationships between the ecliptic and the model of the palace



Figure 9: Relationships between the fresco cycle and three astrological texts



Figure 10: Relationships between the fresco cycle and figurative models from astrological texts

digital model of the palace – or better the various interactive and dynamically explorable models – which guides the visitor through various layers of information; a model that can be seen – in some cases with respect to a user's choice, in others with respect to the layout of the project – as either a non-transparent or transparent structure, either static or dynamic, colored or desaturated, wire-framed or mapped. This important relationship between the building and the sky, today not readily understood largely due to a lack of knowledge about basic astronomy, was a point that we wished to recreate through a series of interactive models expressly created for this purpose.

2.2 Concept of models and interface

The digital model of the Astrarium, an astronomical clock that reproduced the orbits of seven planets based on the Ptolemaic theory of epicycles, seems the best way to introduce the cultural

context which produced the cycle of frescoes in the Palazzo della Ragione. To complete the synoptic-introductory frame, we elaborated a model of the Ptolemaic system that explains the main points of the minimal astronomical assumptions needed for comprehending the complex structure of the astrario (medieval instrument for obtaining the information needed for constructing a horoscope) and that of the astrological fresco cycle. This digital model has been realized like a series of dot-shaped objects – corresponding to the 1,028 stars of Ptolemy's *Almagest* translated by G.J. Toomer and whose positions are expressed in ecliptic longitude and latitude – placed on a spherical surface with earth in the middle. The stars, collected in constellations, have been visualized in axonometrical projection or orthogonal projection on ecliptic plane. Speed and dimension of the planets have been increased to visualize in real time the orbits on the Dondi's Astrarium dials.



Figure 11: Relationships between the fresco cycle and figurative models from astrological texts

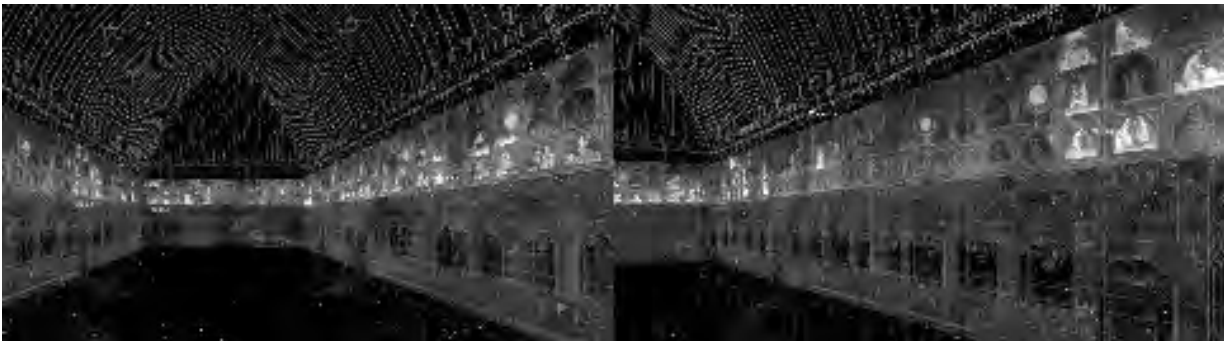

Figure 12: Fresco cycle: the cycle of 1420



Figure 13: Fresco cycle: the restoration of 1763

The creation of a special «astronomical-astrological» initial interface (a menu displaying the names of the planets in the Ptolemaic system, around which keywords move much like satellites and refer to the features of the planets and to the animated descriptions of the project themes) further develops the idea of connecting the Palazzo della Ragione with a «celestial and otherworldly» reality. The lines of the text are made to simulate a universe of galaxies, rather than a simple interactive menu.

Information is structured so that it branches out from seven initial themes: Sun and Justice refer to the architecture of the Palazzo della Ragione; Moon and Nature concern the astrological subject matter of the building; Saturn and Intellect introduce astronomical issues; Mercury and Movement are an introduction to the a-strario; Venus and Beauty apply to the frescoes and decorations in the palace; Jupiter and Power refer to the Paduan patronage and its results in the fresco cycles. In order to return to the initial

interface, one simply needs to click on a cluster of illuminated points found moving about the screen from the second level of information onwards.

2.3 Description of the project

By selecting the first theme, the architecture of the building, you are given two options: an analysis of the building's historical phases, or an exploration of the individual parts of the building's present day structure. The analysis of the historical phases (Figures 1-4) emphasizes the stratified, interactive, and multi-resolution aspects of the building: models which correspond to the different transformations the building has undergone over the course of centuries and, above all, to its present day situation. By touching these models, the planimetric and altimetric information on the building is displayed, as well as by zooming in and out and around such models. If one chooses to explore the



Figure 14: Fresco cycle: the restoration of 1763



Figure 15: Depictions of the zodiac signs from the great hall compared with figurative models taken from Giotto's and Giusto de' Menabuoi's artworks



Figure 16: Depictions of Luna compared with figurative models taken from Liber Introductorius by M. Scoto and the frescoes by Guariento

building's present-day situation, there is the option of exploring either an external or internal view of the building, in a non-transparent or transparent mode (Figure 2). Brief and concise interactive texts are also coupled to particularly significant parts of the model, displaying further details in graphic, photographic, and written form.

For information concerning astronomy (Mercury section), one can analyze, via separate animated and annotated parts of the *astrario* model, the mechanism, structure, function, and connection to the fresco cycle of this complex instrument designed by Giovanni Dondi (Figure 5-6). The Saturn section displays thematic details

regarding the zodiac, the precession of the equinoxes, and the construction of a horoscope (Figure 7).

Astrological themes regarding the fresco cycle, found in the Moon and Nature section, offer a further layering of models: the relationship between the ecliptic – with the twelve constellations forming the zodiac – and the transparent model of the palace where attention is drawn, through the use of color, to the strip of astrological frescoes (Figure 8). The relationship between the ecliptic and the fresco cycle is enhanced further by the fact that the frescos are highlighted as the different constellations of the zodiac are selected. By selecting a zodiac constellation, a

screen appears containing the related frescoes and three different astrological texts (Figure 9). The three texts include a text by Zaparo Fendulo, a text from the court of Alfonso X, and a new edition, published by Johann Engel, of Pietro d' Abano's treatise. In the first section, the cycle's *paranatellonta* (rising constellations, or parts of such, that are extra zodiacal) are compared, based on their proximity, with those found in the three texts mentioned above. In the second section the figurative models from the three texts gradually overlap the cycle's *paranatellonta* when there exists a direct relationship, (Figures 10-11).

The section dedicated to Venus and Beauty, displaying all of the frescoes from the great hall of the Palazzo della Ragione, leads to three further sections containing respectively: the first interventions, the cycle of 1420 (Figure 12) and the restoration of 1763 (Figures 13-14). The first two models of the building – seen from the interior and explorable by zooming in and out of three different points located along the axis of the hall – pertain to different themes and highlight the various positions of the frescoes, which can then be seen separately and in detail by selecting the line of text associated with each. In the section on restoration, by clicking on the individual square panels re-frescoed by Zannoni and visible from the overall model of the hall, the figurative models from Engel's edition of Pietro d' Abano treatise will appear (Figure 14).

Finally, in the section on Jupiter, relative to the astrological cycles and manuscripts from Padua directly or indirectly connected to the building's frescoes, the following information appears: an historical map of the city indicating the places where the fresco cycles are conserved; depictions of the zodiac signs from the great hall compared with likely figurative models taken from Giotto's artwork in the Scrovegni Chapel and from that of Giusto de' Menabuoi in the baptistery of the Duomo (Figure 15); depictions of the planets from the great hall, flanked by likely figurative models taken from *Liber Introductorius* by Michele Scotto and from the frescoes by Guariento in the Church of the Eremitani (Figure 16).

3. CONCLUSIONS

The themes of these sections reflect a preliminary working hypothesis whose principle aim was to realize a communicative system that emphasized the complexity and documental stratifications of an urban monument, but also that was easy to use and understand. The system remains open to closer future examination and hopes to motivate further discussion and proposals concerning new methods for representing and communicating complex works.

4. REFERENCES

- Borgherini, M. - Garbin, E., 2005. *Prototipo di guida interattiva per il palazzo della Ragione di Padova*. In De Rosa, A. (editor), *Orienti e Occidenti della Rappresentazione*, Padova, Il Poligrafo, pp. 73-84.
- Borgherini, M., 2005. *Una «nave per solcare i cieli»: il palazzo della Ragione di Padova e il suo ciclo astrologico*. In *Orienti e Occidenti della Rappresentazione* cit., pp. 85-94.
- Borgherini, M. - Garbin, E., 2007. *Vedere dentro, vedere attraverso, vedere insieme. Per una lettura sintetica di arte, architettura e astrologia nel palazzo della Ragione di Padova*. In e-Arcom 07 Sistemi informativi per l'architettura, Conference proceedings (Ancona 17-19 May 2007), Ancona, pp. 138-43.
- El Asmar, R., 2007-08. *Il museo analogo: un'interfaccia per l'Astrario di Giovanni Dondi*, Università IUAV di Venezia (thesis supervisor: M. Borgherini, co-supervisors: E. Garbin, L. Comacchio, M. Mason).
- Garbin, E., 2005. *Migrazioni delle conoscenze astrologiche tra Oriente e Occidente*. In *Orienti e Occidenti della Rappresentazione* cit., pp. 95-99. Garbin, E., 2005. *Migrazioni delle conoscenze astrologiche tra Oriente e Occidente*. In *Orienti e Occidenti della Rappresentazione* cit., pp. 95-99.

Data Modeling and Measuring Cultural Heritage

CULTURAL HERITAGE, ENHANCED DOCUMENTATION, GEOGRAPHIC WEB, COMMUNITIES AND DATA SHARING. TOWARD THE NEXT STEP IN INFORMATION MANAGEMENT AND ISSEMINATION

Giorgio Verdiani ^a, Massimo Nicolodi ^b

^a Dipartimento di Progettazione dell'Architettura, Facoltà di Architettura, Firenze,

Viale Gramsci, 42, 50100 Italia. info@rilievo.org

^b Giscover.Com, Trento,

Via Lunelli, 62, 38100 Italia. info@giscover.com

KEY WORDS: Laserscan, Cultural Heritage, Modelling 3D, CH, GIS, Interactive, Blog, Geoweb, Geographic, Web Sharing

ABSTRACT:

The present paper proposal will be aimed to focus the main aspect of the next evolution in the wide diffusion of shareable information about Cultural Heritage, trying to underline the issues that can produce a lack of optimization in the process. Considering a workflow starting from the digital survey towards the production of the surface models for managing a monument to the dissemination in the geographic web environments, there will be the need to keep clearly in mind what a process of simplification means, and what kind of steps the gathered data have to take for the production of sharable 3D models more compliant with the usual perceptive human behaviours. Moreover, the building of three dimensional digital models can be considered as a simple game play if not supported by the correct digital space design and by the integration of specific information inside the model in itself. The structure of the information sharing should be correctly suitable to the actual digital community behaviours, creating a real diffusion of the information to all the users and allowing a solid participation thanks to the latest solution of learning and digital relationship. This dissertation will be supported by a series of case studies from the more recent experience in the scientific collaboration between the Dipartimento di Progettazione dell'Architettura and Giscover.com with specific example from the Palladian Villas, some Archaeological monument in Sardinia, some reconstruction and historical evolution in the Tuscany townscape and the combination of outdoor activities, landscape design and geographical web systems.

1. WHERE WE MOVE FROM

This project is about Cultural Heritage, Digital Survey and Geographic Web, it's a project under development, but starting from now, the theories and hypothesis about the use of the geographical web and data treatment in digital survey are mature enough to start some discussion and define some guidelines to orient and enhance the paths to be followed by the high number of operators working worldwide on this important area. In the last years the whole approach to survey and documentation in Cultural Heritage has been under a complete revolution due to the main digital approach.

The great innovation in survey, photography, archives storage, information access, has produced two main effects:

The first is about the way we face the documentation of the monument. Now a day we plan to use these procedures in a completely different way compared to those we used in a past far away from here less then ten years ago; when we meet old style procedures or we found low tech procedures combined to digital survey we can accept them only as an integration and not as something to be compared or as the best suited solution.

The second is about the people expectations in using and accessing the information we have gathered. There is a large desire of knowledge and this knowledge is expected to be easy to access, sharable and to have highly customizable features. A complicated system will stop users from sharing and a too technical approach can limit the range of users even if the level of skills from generic non technical users is now a day raised to a good level.

These double aspects produce a great need to start to enhance the Cultural heritage project to a new level capable to allow a direct sharing of information not only as an occasion to present and create attention over specific cultural events, but to create real occasion where the user can get aware of the cultural environment he is looking at and gain real knowledge from the object of his interest.

At the same time the systems based on the information sharing process can create real benefits from the users, this can happen creating a multiple direction exchange of information, this means that if a main project exist and is under development the users can take an active part in retrieving information add contents and analyze data, it's up to the designer of the project to evaluate and define how the user can participate and how his contribution can became useful.

This part produce an immediate need, the one to coordinate the project not only on the side of the involved technologies but also the one the side to create appropriate interfaces, cognitive systems with a special attention to the relationship with the users and to the relationship the users have each others.

In these terms the communicative world wide system based on the Internet can be still be enhanced and can offer not only passive consultation of contents or resources from users, but can the right base to enhance each single project in its aim to produce knowledge and disseminate it.

2. DIGITAL SURVEY AND HIGH DEFINITION SURVEYS

Now a day there is no doubt that talking about survey methods for architecture, Cultural Heritage, landscape, archaeology and civil engineering, it's the digital survey to be the more important and more interesting group of procedures and that almost any new research in these areas has the part dedicated to the survey based on some solid or innovative digital survey solution. This is true at the research level but is getting more and more the practice at the level of the real operative process, even when the digital survey will be now fully exploited -as it should deserves- by its final users. The laserscan survey solution according to the viewpoint of the researcher is a way to capture a perfect and rich description of a whole monument and easily operate on a high detailed three dimensional representation of the object of the study. Obviously the technology in itself don't guarantee a successful research, nor the fact to use innovative procedures can bring to new discovering by itself, but it greatly helps to face a problem in a research with a very complete and very actual information set, giving sure description of an object removing the problem of its size or of its complexity. Often the main problem is reduced to the choosing the right tool to complete the survey; the scholar need to have the right dataset to work on, and often this problem is reduced to choose the right level of accuracy toward the level of detail required by the aims of the research. The more classical error in this kind of research project is due to the misunderstanding between the level of noise of the tool and the density of the acquired data grid. For example: if a laserscan with an accuracy of six millimetres is used to take a survey of an object with grids where the distance between points is less than this accuracy (for example: four millimetres) the result will be a small disaster with a pointcloud where a lot of points are mixed with others and with the practical impossibility to treat the gathered data without introducing great simplifications. At the same time another common error is the one to over measure an object in front of the real needs and the aims of the research project. This causes an overload on the post production treatment and sometimes creates difficult operative conditions to who works on the production of surface models and drawing representations out of the pointcloud.



Figure 1: During the survey of the so called "Serapeo" in Villa Adriana, Tivoli (near Rome), the double scans for each scanner station done (the first at high and the second at low resolution) allowed to produce a double pointcloud to better fit the different purpose of data treatment.

This common error is due to the fact that sometimes, the researcher or the laserscan operator, fearing not to gather all the needed information during the survey campaign, prefer to gather an high density survey when this is not really needed, the simplest solution to this is simply to double the scans, producing a lower resolution scan before (or after) taking the high resolution one, in this way there will be always the possibility to produce a lower resolution pointcloud immediately, the little more time needed to complete the whole survey in this way is widely rewarded in front of the time the operators will have to dedicate to decimation process and other time consuming operation on the resulted pointclouds.

These considerations about the common errors are done just to focus on the fact that even with a large number of "procedures" experiences the relationships between a completely useful and a common approach to the digital survey technologies from the Cultural Heritage environment is yet to be seen. At the same time, there is the need to define some basic rules about the relationship between the gathered information and their post processing. For "basic rules" is to be intended a common cultural set of shared knowledge based on an accurate understanding on the nature of this kind of survey.



Figure 2: A first definition of the rules between the information as gathered in the digital survey and the post processing procedures.

When those rules will be a common ground the development of research project and practical applications will be much easier and will benefit of an improved approach to any kind of operation planning.

Just for example, one of the rules can be defined to establish the logical process from the gathered pointcloud to the final post process result. When we take the survey using a laserscan solution, we produce a pointcloud as first result of the survey, this digital product represent out of any intention the closest representation of the geometrical model of the surveyed object. The level of accuracy and the density of the pointcloud can depend on the features of the scanner and on certain operative condition, but for that survey the pointcloud will always represent the closest geometrical digitalization of that object. Any post processing operation will bring a better graphical result, but will also bring this result a little far away from the original geometrical correspondence.

At the same time, when we have the pointcloud completed, there is no doubt the result can be very sharp and descriptive,

but is very far from the perceptive model of the original object. Even if we apply real colours to the point cloud or if we create animated video out of the pointcloud, the result is more similar to some medical analysis report than to a real image of the original item. Now this is just an exaggeration, but it gives the idea of the fact that a lot of “old school” operators can have when they see a pointcloud, they see something far from common rules representation and for them is often hard to reach a full use of the gathered information. So at the same time the pointcloud in itself can be considered as the closest to the geometric shape of the object and the more far from the perceptive image of the same object. So any time we introduce a set of operations to move from the original pointcloud toward the a model more near to a realistic perceptive result, we have to keep in mind that we also move away from the better geometrical correspondence to the real object. In facts the point clouds are made of isolated points, so they have a transparency, the first step is often to create a continuous surface from the connection (and interpolation) of the gathered points, the result is always very good, but the result, even if it fit the needs for data analysis is a little bit different from the original pointcloud, it is often not a very important difference, but is a first small difference. Later, when we will add texture, lighting, and other features and tools to create realistic rendering the three dimensional model will need a more strong simplification to allow the operators to work with efficiency on the object. In the end, if we want to add real time access to the three dimensional digital model, we will be in the need to drastically simplify it to allow this kind of operation, so we will obtain a really good perceptive result, but we will be far from the original shape of the gathered points. The same process will happen also if we want to obtain drawing more close to the ones we know from the traditional representation. All the processing needed to create classical horizontal and vertical sections (for example) will produce a gradual simplification starting from the pointcloud, and if, for any reason, we decide to add certain features to create the perception of an handmade drawing the distance from the original accuracy will be enormous. Even if we operate with the best standards and we try to remain as close as possible to the original information, there is no way to avoid this process, we simply have to accept it and include it in the general workflow of our management. This just because it is a rule of this kind of survey.

3. THE PROBLEM OF DATA TREATMENT

Starting from the last considerations it is clear that a very meaningful part of the digital survey is the way the operator plans the survey in itself, but even the best information gathering will be not completely useful if there is not the adequate software and software use choices to bring on the development of the survey.

At the same time there is a really important issue linked to the obsolescence of the file formats and of the software. A problem that don't seem easy to be overcome, while it is linked to the development of the software from a management more interested in copyright and new release selling than in durability of the gathered information.

This is not a small problem, now a day with less than ten years of experiences in the Cultural Heritage survey; all the product developed starting from a laserscan survey are easily accessible and allow having a complete three dimensional image of a monument, but what there will be in the next ten or twenty years? A Cultural Heritage survey should be something durable,

capable to allow a confrontation in time of the evolution of the monument in itself; famous survey from Historical Patrimony taken in the Eighteen century are still today an useful base of confrontation with laserscan survey, allowing to understand in details how the monument is changed in a certain timeline. If in the past the decay of the paper was the main issue to destroy the gathered information, now a day the software obsolescence is the actual enemy to the preservation of the knowledge operated with the day's survey tools.

According to the actual software development state it seem there is no a clear path to try to allow a secure preservation of the digital surveys. It seem clear enough that creating an archive based on the simplest format available can give a good chance to recover information also after a strong change in a specific software, as well the production of 3D and 2D representation can allow a longest life to the information coming from the surveyed monument. This is not a secondary issue, it is quite clear that in the future the survey of a monument will become useful, it can become a fundamental base of knowledge immediately after a damage to the monument, but it can be useful to monitor the transformation in time for any monument, and it is really clear in our days how this can be achieved with laserscan technology better than any other survey solution.

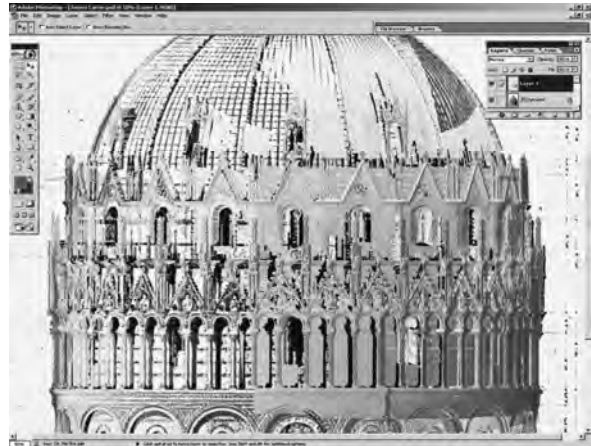

Figure 3: The compare between the digital survey of the Baptistery of Pisa, done in 2002 and the traditional survey done by Crazy and Taylor starting from 1817 (here in a drawing from James Carter). The confrontation allows operating some useful consideration about the changes in the monument and about the characteristic of the survey in itself.

There is also another path to be considered to enhance the preservation of the digital surveys and is the way to share them in certain specific solutions, trying to distribute certain level of information coming from these surveys in a way to allow this data to face better time and obsolescence. But this only an idea at now and the experience organized around the sharing of this kind of data seem more focused on the (right) contents protection than on the real sharing possibilities.

4. BRINGING BACK LOCAL INFORMATION TO A GLOBAL REFERENCE SYSTEM

When a Cultural Heritage monument is surveyed, all the gathered information is registered on a local coordinate system. It is in the nature of these surveys to have a final, single reference system, this can be referred to a global reference

system, using a GPS or connecting the local system to any national one. In this way the single laserscan surveys became “parts” of a digital global representation of the world, and even if they are not directly connected each other, we can image a creation of a digital (and accurate) version of the world which is completed little by little by single, random, survey operation, done in different moment in time.

If this is true for the pointclouds generated by digital survey, it became even more true for the three dimensional models produced out of these surveys.

The production of highly simplified models can find a nice location on the actual web based geographical systems, creating an even more tangible impression about the creation of a digital version of the world accessible almost by anyone.

The fact that these simplified models are capable to act like a collection of links to other resource around the Internet can allow the development of a real three dimensional browsing system starting from the shape of the world as we have modelled it.

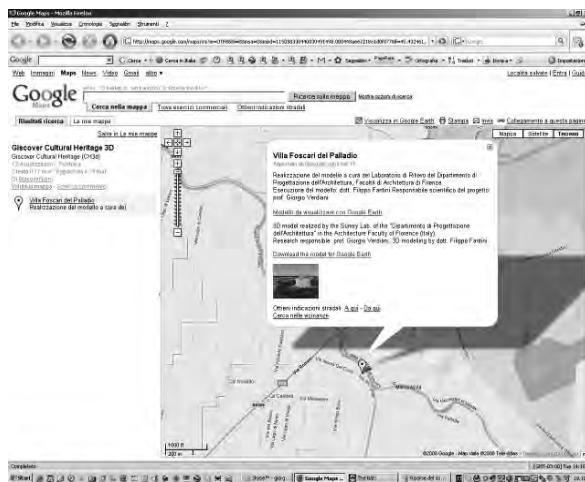

Figure 4

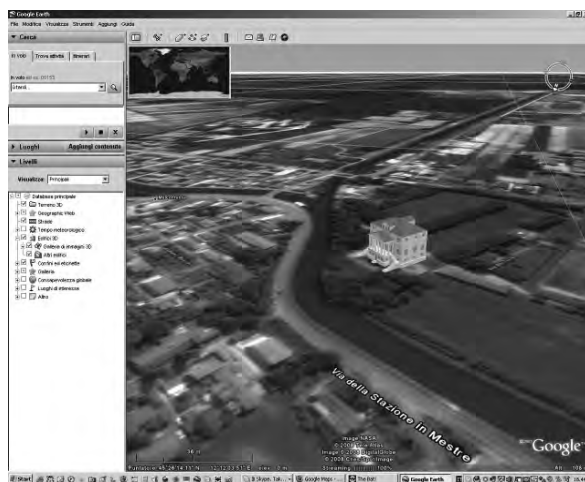

Figure 5



Figure 6

Figures 4, 5, 6: A sample of the location of a highly simplified three dimensional model: the “Villa Malcontenta” from Andrea Palladio, near Vicenza, Italy.

The model can be located as a browsable resource over a classic bidimensional map, and later can be located in the Google Earth environment.

A lot of stunning examples are coming from an interesting ground testing like Google Earth, and the full implementation of GPS navigation system in the next generation of Mobile phones is bringing to the final development level the possibility to access the data directly from the place where it is supposed they are linked to, generating what we can start to call “amplified reality”. This can be a great choice also for the operators in the Cultural Heritage: while they can access this complex system on a double level, one will be the level of the communication of the contents and of the results of a research, mainly based on the use of simplified models to capture the attention and to drive the choices from the users to access the available contents. The other level could be the direct access to all the information coming from the survey in itself, using also for this an access based on low number of polygons models, but allowing the access to authorized operators only, filtering the access and reserving the complete data mining to specific users. This double solution can give an interesting chance to the geographical web system, while it would allow a simple and worldwide access to resource using a very simple process. The fact to refer the information directly to their world location will allow simplifying the information search, while the fact to allow any kind of contents to the links connected to a simple model will allow to fully benefiting from classic web search engine procedures.

The digital surveys are not the ideal items to produce models for real time rendering (even when it is a really simple rendering), but overall they will allow to produce very reliable models, while they will be based on a very good survey. The strong basis on which the building of the three dimensional models for web geographical access will be the right basis to develop this innovative process. The creation of model with sure dimensions, sure proportions and developed by the Cultural Heritage operators around the world are the better way to build this environment or it will be quickly filled with a lot of “trash” models with a serious risk to drop down the interest in this solution of information access.

5. BRINGING PEOPLE TO BENEFIT OF THESE DATA SETS

The great challenge that the digital Cultural Heritage access and the Geographic web offer to the research is a really multi-disciplinary landscape. On one side there is the problem to create really well working environments to allow all the data to work together in a quick and easy way. On the other there is the need to bring the access to all the potential users, and to produce a real enhancement in the access to knowledge. A simple browsing of models or information can not keep the attention of the user for a long time, while it is clear that a serious interaction is needed to allow those environment to be lively and bring high the level of attention from the users.

Large collections of data obtained through digital surveys of monuments and artefacts exist. The gathered information around the world can produce a rich collection of accessible knowledge, but at the same time there is the need to develop a structure capable to justify the effort to share precious data with users from the researcher and have a reasonable return in the overall economy of the process.

6. SHARING IS A MULTIPLE DIRECTION PROCESS

The building of sharable resource about Cultural Heritage can bring benefit to who build the contents and to who access the contents and this doesn't mean to have to pay for access the contents, not necessarily. All the people around the world meet continuously the object they found as a three dimensional model on the web, and they can give useful information and act like an additional monitoring on a monument with the sharing of their experience on that monument. More over a structure based on "levels" of access can offer a better managing of the users and can give a good level of sharing according to the needs of the single users.

Actually there still exist very interesting examples of 3D libraries capable to act as a connection between the model in itself and a collection of classical information is found at www.greatbuildings.com where the huge amount of massive and simplified models of architecture allow focusing the attention of the shape of the monuments.

At the same time large collection of 3D models, like those from www.turbosquid.com or www.the123d.com (just to mention two interesting portals) seem to be aimed mainly to the selling of 3d models, suggesting the access to only virtual 3D models for purchase without giving any possible enhancement of the existing items from the users. Interesting projects based on 3D graphic visualization or aimed to collect and organize 3D models contents, like or www.virtualheritage.net, the 3D Google Warehouse (www.sketchup.google.com/warehouse) or the CyArk High Definition Heritage Network (www.cyark.org) are not directly connected to geographical web. In the archaeological arguments like finds access and reconstruction, the more advanced project like the Digital Forma Urbis Romae Project or the Rome Reborn project (www.romereborn.virginia.edu) are expressly aimed to the visualization on the screen of rich contents, even if, at now, they seem not oriented to include a direct relationship with geographical web solutions.

The more actual samples about the way to link can be found in the Google earth environment, very interesting work like the digital reconstruction of the actual Berlin ([\[berlin.de\]\(http://berlin.de\)\) and create an interesting point of reference for the development of new experiences. As told before, we believe that the future challenge is in bringing the user to directly add and interact in the contents, according to process that will be refined and developed along the road of the general experience and that will allow the user to access the information about Cultural Heritage as a starting point to enhance their knowledge and their consciousness about the monuments and the artistic patrimony in their own country and in other parts of the world.](http://www.virtual-</p>
</div>
<div data-bbox=)



Figure 7: A screenshot from the Virtual Berlin model in Google Earth, the level of available information is very high and even if the city is still far from being completely covered; the overall result is impressive.

The development of small, medium or large online community can even more enhance the attitude to share materials and information, with an immediate positive feedback to the general knowledge about the main item (the monument, the archaeological site and so on...).

If a community of this kind will start to be fully functional the benefit will be almost immediate for the whole community.

Even more those solutions can be combined to slightly different environment, like the one aimed to offer GPS paths for outdoor sportive practices. For example the planning of path across the mountains can allow making easier and safer the access to the natural patrimony, but even more can allow to preserve the landscape bringing people to visit ancient paths and historical monuments along this paths. In this way, even if the ancient road has lost its original meaning because new paths and new behaviours have outdated it, the outdoor activities can preserve it and produce a minimum monitoring on the areas giving better chances to preserve that landscape and that historical patrimony from decay.

The actual community based on sharing, like the well known Youtube.com or Flickr.com base their logic to the interaction of their users around creative items that give the opportunity to build relationships between the users themselves, exchanging knowledges and learning from each other.

In the Giscover.com experience, the CH3D, the Cultural Heritage 3D, will be aimed to offer a space of interaction around Cultural Heritage based on 3D start contents.

The logical structure of the Giscover.com community and the use of resource coming from a cultural enhanced environment like the Faculties one, can bring to the development of really interesting contents, where the research activity is the center engine of the whole process and where all the users can find and

add their own contribution and participate to a common growing of the way to access Cultural Heritage knowledge.



Figure 8



Figure 9

Figures 8, 9: Two screenshots from the Giscover.com website, the main page and one of the GPS paths available for download. Even if actually the main use of this kind of solutions is aimed to produce product for sport activities the same working structure can be used as a starting base to develop Cultural Heritage access contents.

7. REFERENCES

- Martin C. Brown, *Hacking GoogleMaps and GoogleEarth (ExtremeTech)*, Wiley, 2006.
- Cina Alberto, *GPS. Principi, modalità, tecniche di posizionamento*, CELID, 2000.
- Elliott D. Kaplan and Christopher Hegarty, *Understanding GPS: Principles and Applications, Second Edition*, Artech House Publishers, 2005.
- Stefano Campana e Riccardo Francovich, *Laser scanner e GPS. Paesaggi archeologici e tecnologie digitali*, edizioni All'Insegna del Giglio, 2006.
- Crosilla F. e Mussio Luigi, *Metodi e procedure di modellizzazione e trattamento dei dati GPS*, CISM, 1994.
- Robert I. Egbert, *The GPS Handbook, Revised and Updated Edition: A Guide for the Outdoors (GPS Handbook: A Guide for the Outdoors)*, Burford Books, 2008.
- Ahmed El-Rabbany, *Introduction to GPS: The Global Positioning System, Second Edition*, Artech House Publishers, 2006.
- Chandler Evans, *Future of Google Earth*, BookSurge Publishing 2008.
- Paul A Longley, *Geographic Information Systems and Science*, John Wiley, 2005
- David M. Mark, *Cognitive and Linguistic Aspects of Geographic Space*, BPOD, 1992
- Arno Scharl and Klaus Tochtermann, *The Geospatial Web: How Geobrowsers, Social Software and the Web 2.0 are Shaping the Network Society (Advanced Information and Knowledge Processing)*, Springer, 2007.
- Michael Purvis, Jeffrey Sambells and Cameron Turner, *Beginning Google Maps Applications with PHP and Ajax: From Novice to Professional*, Springer, 2007.
- Jan Van Sickle, *GPS for Land Surveyors, Third Edition*, CRC, 2008.
- A very large number of websites can be visited to find references about the social and the geographical web in this beginning of the century, as simple reference here we list the main reference websites as the starting point to find all the huge landscape of knowledge and information.
- First of all the reference website where all the proposed considerations are growing: www.giscover.com the site is continuously under update, last access while writing this article: 5 September 2008.
- Probably the most famous search engine around the web, but also the starting point of one of the major innovation in the Internet since its diffusion: www.google.com and its main geoweb development earth.google.com.
- A very interesting community based on the sharing of images, capable to tag the images with geographical reference: www.flickr.com last access to the "geotagging" system done in the middle September 2008.

INDEXING HERITAGE DOCUMENTS IN ENCYCLOPEDIAS USING OPTIMIZED NAMED ENTITY RECOGNITION TECHNIQUES

Dhwaj Raj, Ratna Sanyal

Indian Institute of Information Technology Allahabad, Jhalwa, Allahabad, Uttar Pradesh - 211012, India -
(draj_b05,rsanyal)@iiita.ac.in

KEY WORDS: Cultural Heritage, Encyclopedia, Named Entity Recognition, Conditional Random Fields

ABSTRACT:

We present a novel approach for indexing documents related to cultural heritage in large repositories to construct the encyclopedias. With an advent number of large repositories of digital documents the need for text indexing and searching techniques has increased tremendously. We present an approach to index documents related to cultural heritage using named entity recognition techniques on the text. It is a part of information retrieval problem based on semantic tags. Our system uses optimized named entity recognition method which combines extensively analyzed phonetic matching and statistical machine learning based approaches. For the task of finding named entities statistical approach is designed over conditional random fields based models. Using named entity tags for indexing heritage documents enables fast and accurate retrieval system. The system presented here is currently under evaluation.

1. INTRODUCTION

The heritage documents are precious and need to be preserved for future. Storing and conserving physical records requires high cost and can not be stored for a long period of time. The preservation of heritage documents can be done by constructing large repositories to store these documents in electronic format (E. Paquet et. al, 2006). With a large number of such archives there is a necessity to make the information of these documents easily accessible to the user.

Heritage documents can be preserved electronically as images, text and multimedia. In our system we focus in indexing heritage documents available as text or containing a corresponding text obtained after applying optical character recognition on image data. There are numerous systems available to extract text from images (Impedovo et al, 1991). Not going into the details of OCR we describe our system in this paper, assuming that text corresponding to a heritage document is already available.

Searching and browsing queries on documents generally require semantic knowledge of all the documents. To make the retrieval task precise keywords are indexed with each corresponding document in the repository. This indexing task requires keyword extraction from contents of the documents. In our system we index the documents after extracting named entities. Named entities can be categorised in semantic classes like 'person', 'organization', 'place', 'dates' and 'numbers' etc. Hence it becomes possible to perform hierarchical indexing on the stored documents.

For named entity recognition (NER) from the text, main task is to extract named entities and classify them into the predefined categories (Chichnor, 1997). In our system we aggregate phonetic matching and machine learning approaches. Our Output is processed by rule based post-processing module. Conditional Random Fields (CRF) presents a conditional probabilistic model for sequential tagging based on feature function (Andrew McCallum, 2003). CRF overcomes problems of other Bayesian models like label biasing and absence of context features. Indexing based on named entities not only

allows semantic queries but such systems can also perform question answering based on knowledge of all the documents. Potential access to digitized heritage documents is complicated as the number of users accessing the repositories is increasing tremendously.

Our paper is organised as follows: we discuss related work in the field of heritage documents indexing in section 2, section 3 discusses phonetic matching for named entities recognitions and section 4 presents statistical approach for NER using conditional random fields. In section 5 we describe document indexing using aggregated and optimized named entity recognition. We conclude our work in section 7.

2. RELATED WORK

In the field of document indexing a lot of approaches are studied. Many systems require manual extraction on keywords by intervention of experts. It has been shown that semantic tagging is the most crucial task towards a more efficient information retrieval system (Finkel et al, 2005). There are some approaches for indexing 2D and 3D heritage data (P. Grussenmeyer et al, 2006). Many instances of research in the field of digital libraries can be found easily. There are numerous digital library applications using XML based metadata for document retrieval (Lavanya Prahallad et al, 2006).

Techniques for named entity recognition are well analyzed both in the fields of natural language processing and bioinformatics. NER tool being developed at Stanford University (Shipra Dingare et al, 2004) uses MEMM (Hai Leong Chieu et al, 2003) and other similar statistical methods to recognize NEs. They are working on improving sequence classifier and also make use of CRF. A system describes to integrate multimedia approaches for preserving cultural documents (M Farrag, 2006) which uses situation dependent delivery of documents in the form of images, text, audio and video etc. They make use of ontology, such as WordNet and AAT to provide access across various repositories. Various digital library systems define specific metadata definitions according to the type of data being indexed

in the respective libraries (Steven Bird et al, 2003). They extend Doubling core specifications to develop a generic metadata scheme.

3. PHONETIC MATCHING

With a well tagged corpus of all known named entities we match similar sounding NE from the given text. Requirement of phonetic matching instead of simple string matching is generated due to spelling errors in text obtained after transliteration or OCR. The idea for using phonetic matching for NER is to match the two representations of same named entity using algorithms for phonetic matching described in detail below (Zobel et al, 1996).

3.1 Soundex Algorithm

Soundex algorithm was designed to match spelling variants of a word. It was patented in 1918 by Odell and Russell. In soundex sets of characters are defined such that each set represent similar sound. We have modified the Soundex algorithm after a number of experiments and the algorithm used in our system is described below.

- Retain the first letter of the word.
- Change letters belonging to the sets into the digit according to table 1.
- Remove all pairs of double digits like in a600552 -> a6052
- Now remove all occurrences of '0'.
- Return code.

0	A E I O U Y W H
1	B F P V
2	C K Q
3	D T
4	L
5	M N
6	R
7	X Z G J S

Table 1: character set for modified Soundex Algorithm

Taking an example for names "Harryz", "Harish" and "Harison", we get the soundex codes as "H67", "H67" and "H675" respectively. Hence the different names can be matched using Soundex algorithm. There can also be found some Soundex variants such as 'Phonix' etc. Soundex does not provide any ranking to strings that how close they are. Also, in Soundex the sets are made considering the common sound of the letters instead of considering the context.

3.2 Editex Algorithm

Editex algorithm has evolved from Levenshtein edit distance algorithm and it also fuses the Soundex type replacement cost for each set of letters. It was proposed by Zobel and Dart (1996). For the Editex also we changed the sets after a rigorous analysis on a large data set. The letter sets and algorithm are described in table 2 and table 3 respectively.

0	KQ
0	BWY
0	IY
0	JZX
0	FP
0	OU
1	AEIOUYH
1	CKQ
1	DT
1	LR
1	MN
1	GJ
1	BFV
1	XS
1	CSZ

Table 2: Modified Editex character sets

```

for each i from 0 to |s|
  for each j from 0 to |t|
    editex(0,0)=0
    editex(i, 0)=editex(i-1, 0) + d(si-1, si)
    editex(0, j)=editex(0, j-1) + d(tj-1, tj)
    editex(i, j)= min[editex(i-1, j) + d(si-1, si);
                      editex(i, j-1) + d(tj-1, tj);
                      editex(i-1, j-1) + r(si, tj) ]

```

Table 3: Editex Algorithm

In the above algorithm the function of $r()$ and $d()$ are:

- $r()$ returns 0 if two letters are identical or they belong to the same set with cost 0, 1 if both letters belong to same set of cost 1 and 2 otherwise.
- $d()$ same as $r()$ but it neutralizes h and w (i.e. on passing 'h' or 'w' as first parameter in $d()$ returns 1 even if second parameter is not the same as first).

We have introduced many optimizations in phonetic matching techniques and modified the sets of Soundex and Editex algorithms to produce better results.

3.3 Combining Results of Modified Soundex and Editex

We apply our Soundex and Editex Algorithm on two strings, say s_1 and s_2 . Let the soundex codes for both the strings are c_1 and c_2 . Then the following procedure is applied.

1. Pad '0' in smaller code until both c_1 and c_2 are of same length.
2. Calculate percentage of match in c_1 and c_2 .
3. Get cost from Editex algorithm for flattened s_1 and s_2 .
4. Normalize the cost as:

$$\text{Normalizedcost} = 1 - (\text{cost}/(L1+L2)) \quad (1)$$

$$P(T,X) = \exp(\mathbf{w} \mathbf{F}(T,X)) / N_{\mathbf{w}}(X) \quad (4)$$

5. Probability of finding a match using Soundex match and Normalizedcost (Editex) can be given as :

$$p = (w1 * \text{SoundexmatchPercentage}/100 + w2 * \text{Normalizedcost}) / (w1 + w2) \quad (2)$$

6. In our task of phonetically matching string the weights w1 and w2 are taken as 0.75 and 0.25 and the probability value of 0.69 is taken as threshold. So $p > 0.69$ is a match but these values can be adjusted accordingly.

4. STATISTICAL APPROACH USING CRF

4.1 CRF Model

CRF is a widely used model for tagging sequential data. It is a probabilistic framework based on conditional approach which has been successfully used in various domains. A CRF is a type of undirected graph which defines a log linear distribution of possible label sequences for a given observation sequence. Model of a linear-chained CRF is presented in figure 1.

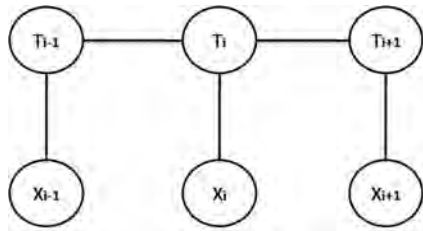

Figure 1: undirected graph for linear-chained CRF model

We can represent the text as a sequence of words. We may assume a set of p distinct classes which will be assigned to each word where p is the number of scene categories for example 'location', 'organization' and 'person' etc. CRF model provides the conditional probability of a given tag sequence $t = t_1, t_2, \dots, t_m$ given the input sentence $x = x_1, x_2, \dots, x_m$. We are using two random variables T and X to denote any tag sequence and a sentence respectively. A CRF on (X, T) is specified using following variables:

- f which is feature vector for each word.
- w corresponding weight vector to f .
- Probability $P(T|X)$
- $s(t_i, x, i)$ which represents state feature functions
- $p(t_{i-1}, t_i, x, i)$ which represents position-transition feature functions.
- F represents global feature vector given by the equation

$$\mathbf{F}(t,x) = \sum_i f(t, x, i) \quad (3)$$

We can assign a T with maximum probability to the input X. The conditional probability distribution defined by CRF is,

Where normalization factor can be given as,

$$N_{\mathbf{w}}(x) = \sum_t \exp(\mathbf{w} \mathbf{F}(t,x)) \quad (5)$$

We can train a CRF by maximizing the log likelihood of training set $\{(x^{(k)}, y^{(k)})\}_{k=1}^N$ (Tzong-han Tsai et. al, 2006).

4.2 Feature Selection for CRF model

Feature selection is the central task for any machine learning system (Casey Whitelaw,2003). We calculate feature values for each word in a sentence and then map those values into the Boolean values to generate a feature vector. Below we describe classes of features used for our CRF framework (Tzong-han Tsai et. al, 2006).

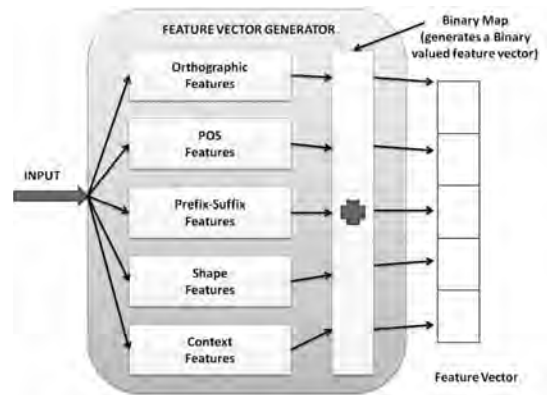

Figure 2: feature vector generator for NER

4.2.1 Context Features: The probability of a word falling into a specific class is much affected by the word following or preceding the current word under investigation. But there should be a check on context window as a large size of window being used may complex our task. If a word is "Dr" or a category 'designation' then there is a high probability of next word being a 'person'.

4.2.2 Orthographic Features: In orthographic feature class the functions check the word composition and the basic functions in this class of features are 'ISDIGIT', 'CONTAINSDIGIT', 'ISSINGLECHAR', 'ISDATEFORMAT' etc.

4.2.3 Prefix-suffix Features: This class of features check for presence of common prefixes and suffixes for each word. The prefix-suffix information of a word also contributes in probability of a word being recognized as a NE. Some examples of prefix-suffix features used are 'SUFF_CITY', 'SUFF_YORK' etc.

4.2.4 Shape Features: The word shape of a feature also contributes towards NER framework. In these features we check for shape of a word when all alphabets except for vowels. A word 'Hazard' is coded as 'Kakakk' and we can match word codes of various words.

4.2.5 Part-of-speech Features: System uses the POS tagger system (Banko et al, 2004) to tag each word with part-of-speech tags like 'verb_phrase', 'noun_phrase' etc. After tagging the words with POS tags, NER task becomes very easily assessable.

5. OVERALL DISCRIPTION OF THE SYSTEM

5.1 NE Training Module

Training model is described diagrammatically in figure 3. For training our NER framework the already tagged test files are given as input. The corpus of tagged text data can be produced manually by intervention of experts. A tagged sentence is sent to feature vector generator which produces a feature vector for this sentence. This feature vector and the tag sequence for the given sentence are passed to CRF model which produces weight vector after normalization and contributes towards the knowledge base. The more be the amount of training data more will be the accuracy at the time of recognition because more training leads to a polished knowledge base.

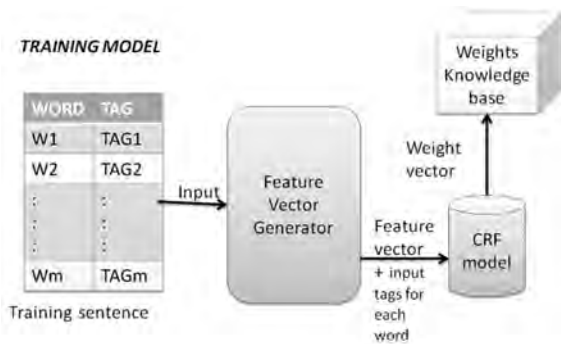

Figure 3: Training model for NER

5.2 NE Recognition Module

For NE tagging in a new text, our recognition module produces tagged sentences (Kim et al, 2000). A sentence from input text is sent to phonetic tagging module followed by feature vector generator. The phonetic tagging module tags all the words which can be phonetically matched with already tagged NE corpus. The feature vector computed for a sentence is combined with weight vector, produced by the trained knowledge base and then sent to the Tagger. Tagger calculates log-likelihood for each possible tag sequence and assigns the tag sequence with maximum log-likelihood to the sentence. Repetively each and every sentence extracted from the input is tagged by this model. In the figure 4 below we present recognition model for our system.

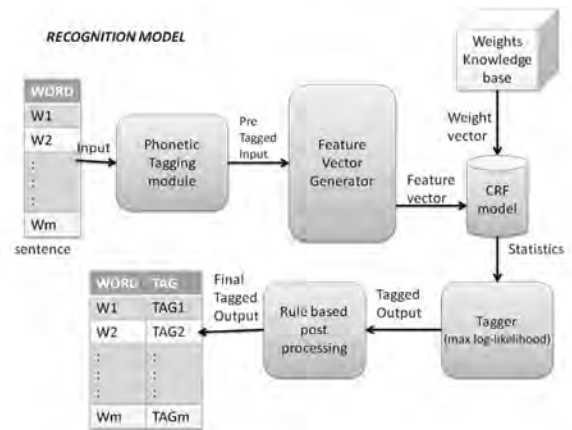

Figure 4: NE Recognition model

5.3 Document Indexing in repository

After extracting and recognizing the named entities for given documents we index the documents using these NEs as keywords. The phases involved in our system, for indexing culture documents are:

- Extract corresponding text from heritage documents using OCR etc, if needed.
- Select a trained model for CRF frame work according to the domain of the given document.
- Extract the named entities from the text.
- Use named entities as low level keyword and their class like 'person', 'place' etc as high level keywords.

For each query to access the content of the repositories we put major weight to NE keywords and hence it leads to better search experience and the degree of relevance is better in search results. System architecture is presented clearly in figure 5 below.

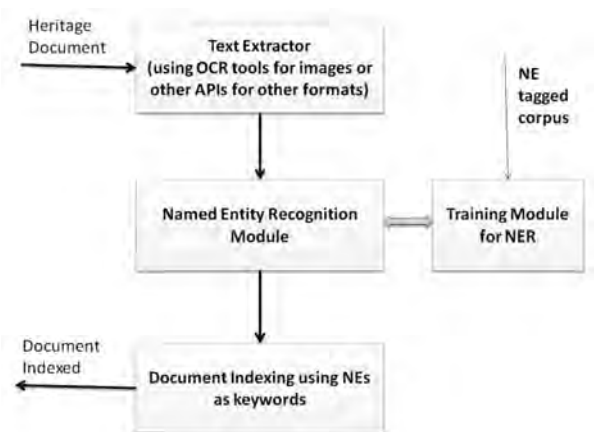

Figure 5: System Architecture

6. CONCLUSIONS AND DISCUSSIONS

We have presented an approach to index heritage documents in large repositories by using NER to extract named entities and to use them as keywords. We experienced a significant decrease in number of documents retrieved as search results where as the degree of relevance of search results boosted up.

Our named entity recognition system can be applied on multilingual data as it uses language independent approaches. Our approach increased the quality of information retrieval system for heritage document.

Still, various improvements can be made in our system for providing better accuracy. We intend to apply string factorization for fast IR. In future more features can be added in CRF model to improve the results.

7. REFERENCES

Andrew McCallum and Wei Li, 2003. Early results for Named Entity Recognition with Conditional Random Fields, Feature Induction and Web-Enhanced Lexicons. In: *Proceedings of CoNLL-2003*, Edmonton, Canada.

Banko, Michele and Robert C. Moore, 2004. Part of Speech Tagging in Context. In: *Proceedings of 20th International Conference on Computational Linguistics (Coling 2004)*, Geneva, Switzerland, pp. 556-561.

Casey Whitelaw and Jon Patrick, 2003. Named Entity Recognition Using a Character-based Probabilistic Approach. In: *Proceedings of CoNLL-2003*, Edmonton, Canada, pp.196-199.

Chinchor, 1997. Named entity task definition. In: *Proceedings of the 7th Message Understanding Conference (MUC-7)*. Washington D C, USA.

E. paquet , C.Lahanier et. al, 2006. Context base Indexing and retrieval of cultural heritage data and integrated approach to documentation with application to the EROS database. In: *Proceedings of VAST 2006 conference*. Cyprus.

Finkel, Jenny Rose, Grenager, Trond et al, 2005. Incorporating Non-local Information into Information Extraction Systems by Gibbs Sampling. In: *Proceedings of the 43rd Annual Meeting of the Association for Computational Linguistics (ACL 2005)*, pp. 363-370.

Hai Leong Chieu and Hwee Tou Ng, 2003. Named Entity Recognition with a Maximum Entropy Approach. In: *Proceedings of CoNLL-2003*, Edmonton, Canada, 2003, pp. 160-163.

Impedovo et al, 1991. optical character recognition- a survey. *International Journal of Pattern Recognition and Artificial Intelligence*, 5(1/2) pp. 1 – 24.

Kim, J. and Woodland, P.C. 2000. Rule Based Named Entity Recognition. Technical Report CUED/ FINFENG/ TR.385, Cambridge University Engineering Department.

Lavanya Prahallad, Indira Thammishetty, E.Veera Raghavendra and Vamshi Ambati, 2006. A tool for entering Structural Meta data in Digital libraries. In: *Proceedings of International Conference on Universal Digital Libraries (ICUDL)*, Egypt.

M Farrag, 2006. The Application of Interactive Multimedia Technologies for Cultural Heritage Documentation. In: *Proceedings of VAST 2006 conference*, Cyprus.

Muller, Boochs et. al, 2006. Digital Documentation of cultural heritage Objects Using Hybrid Recording techniques. In: *Proceedings of VAST 2006 conference*, Cyprus.

P. Grussenmeyer, P. Patias et. al, 2006. A Proposed Low-cost System for 3D Archaeological Documentation. In: *Proceedings of VAST 2006 conference*, Cyprus.

Shipra Dingare, Malvina Nissim, Jenny Finkel, Claire Grover, and Christopher D. Manning. 2004. A System For Identifying Named Entities in Biomedical Text: How Results From Two Evaluations Reflect on Both the System and the Evaluations. *Comparative and Functional Genomics* 6. pp. 77-85.

Steven Bird ,Gary Simons, 2003. Extending Dublin Core Metadata to Support the Description and Discovery of Language Resources. *Journal of Computers and the Humanities*. Volume 37, Number 4 . pp. 375-388.

Tzong-han Tsai et. al, 2006. Integrating Linguistic Knowledge into a Conditional Random Field Framework to Identify Biomedical Named Entities. In: *Proceedings of the 2006 Conference of the North American Chapter of the Association for Computational Linguistics on Human Language Technology*. pp. 243 – 246.

Zobel, Justin and Dart, Philip. 1996. Phonetic string matching: Lessons from information retrieval. In: *Proceedings of the Eighteenth ACM SIGIR International Conference on Research and Development in Information Retrieval*. Zurich, Switzerland, pp. 166-173.

8. ACKNOWLEDGEMENTS

Authors acknowledge financial support from Technological Development of Indian Languages (TDIL) project, Ministry of Communication and information Technology, New Delhi, India.

REGISTRATION OF ANCIENT MANUSCRIPT IMAGES USING LOCAL DESCRIPTORS

M. Diem, R. Sablatnig

Pattern Recognition and Image Processing Group, Institute of Computer Aided Automation,
Vienna University of Technology, Austria, diem@prip.tuwien.ac.at

KEY WORDS: Ancient Manuscripts, Registration, Local Descriptors, SIFT, Cross Correlation

ABSTRACT:

One medieval Slavonic manuscript is recorded, investigated and analyzed by philologists in collaboration with computer scientists. The script is degraded due to poor storage conditions. In order to enhance the degraded script, the manuscript pages are imaged in eleven bands between 330 and 1000 nm. A registration, aligning the individual spectral images, is necessary so that further image processing algorithms can combine the information gained by the different spectral bands. The camera system which was used to capture images of the manuscript pages and the algorithms used for the registration are presented in this paper. Finally, results of tests on real and synthetic images are given.

1. INTRODUCTION

The codex, which is analyzed in cooperation with philologists of the University of Vienna, is called Cod. Sin. Slav 5N and was written in the 11th century. It is written in Glagolitsa which is the oldest known Slavic alphabet and consists of 162 pages. Each page was captured eleven times in different spectral bands which results in a total number of 1782 images that have to be registered.

In this paper a method for a fully automatic image registration is presented. The aim of multi-spectral imaging is to enhance and make the degraded script visible respectively. Since manual operations such as repositioning the pages or camera changes are performed between the acquisitions, a registration that aligns one spectral image to the other is necessary. If the images are registered, they can be combined, using for instance a principal component analysis.

Since the manuscript pages are repositioned between both cameras, the algorithm must be able to handle rotations up to 180° between the images. Thus, a modified Scale Invariant Feature Transform (SIFT), which is rotationally invariant, aligns the images coarsely. Wrong point matches are eliminated by computing the distance to the second nearest neighbor and the Random Sample Consensus (RANSAC) method. Afterwards the images are aligned by estimating the affine transformation matrix using the Least Squares Solution. Having aligned the images coarsely, the cross correlation is computed. A local weighted mean mapping function, which is a local polynomial transformation, is estimated by means of the corresponding control points. Hence, non-linear local distortions caused by the changing curvature of the pages are corrected.

The paper is organized as follows. The following section characterizes related work. Section 3 gives an overview of the image acquisition system, which was installed at the monastery. Section 4 describes the image registration in more detail. Numerical and visual results of the stated methods are given in Section 5. Finally, the last section gives a conclusion.

2. RELATED WORK

Multi- and hyper-spectral imaging has been used in a wide range of scientific and industrial fields including space exploration like remote sensing for environmental mapping, geological search, medical diagnosis or food quality evaluation. Recently, the technique is getting applied in order to investigate old manuscripts (Balas et al., 2003). A representative is the Archimedes Palimpsest (Easton et al., 2003). Easton et al. were the first to capture and enhance the erased writing of the Archimedes palimpsest by multi-spectral methods (Easton et al., 2003). In that project it turned out that the adoption of spectral imaging produces higher and better readability of the texts than conventional thresholding methods.

Two cameras, in contrast to the mentioned imaging systems, are used in this approach. A grayscale camera with an automatic filter wheel takes seven images in different spectral bands. Additionally, color images and UV fluorescence images are taken with a second camera. By aligning the images from both cameras to each other up to eleven channels per pixel are available for further processing steps.

Image registration is the process of estimating the ideal transformation between two different images of the same scene taken at different times and/or different viewpoints. It geometrically aligns images so that they can be overlaid. An overview of image registration methods is given by Zitová and Flusser (Zitová & Flusser, 2003).

Zitová et al. (Zitová et al., 2004) tried to find damages of medieval mosaics by comparing current images to historical photographs of the mosaics. Therefore images showing the same mosaic details needed to be registered. Zitová proposes to manually select 20 corresponding points in each image. Inaccuracy caused by the manual selection is reduced by means of the mutual information method (Viola et al., 1995). Cappellini et al. (Cappellini et al., 2005) took multi-spectral images of paintings which needed to be registered since misalignments arose from different optical paths. They propose an MMI-based registration which estimates the geometric parameters based on mutual information.

In contrast to these applications, images taken with different cameras are registered automatically in our approach.

3. IMAGE ACQUISITION

Since photographic techniques in the visible range have proven to be insufficient with degraded manuscript pages, spectral imaging is applied (Balas et al., 2003; Rapantzikos & Balas, 2005). Images in different wavelengths provide information that is invisible to the human eye (Rapantzikos & Balas, 2005). Generally, there are narrow spectral bands at which the maximum difference in the reflectance characteristics of each ink exists (Mairinger, 2003). The aim of multi-spectral imaging is to provide spectral image cubes, where the third dimension contains spectral information for each pixel. The degraded script is enhanced by combining the spectral information.

For the acquisition of the manuscripts a Hamamatsu C9300-124 camera is used. It records images with a resolution of 4000 x 2672 px and a spectral response between 330 and 1000 nm. A lighting system provides the required IR, VIS and UV illumination. In order to speed-up the acquisition process software was developed which controls the Hamamatsu camera and the automatic filter wheel that is fixed on its object lens. Thus, the user can specify which optical filters to use and camera parameters such as exposure time. Having specified all parameters, the software takes the spectral images and stores them on the hard disk.

Low-pass, band-pass and short-pass filters are used to select specific spectral ranges. The near UV (320 nm - 440 nm) excites, in conjunction with specific inorganic and organic substances, visible fluorescence light (Mairinger, 2003). UV reflectography is used to visualize retouching, damages and changes through e.g. luminescence. Therefore the visible range of light has to be excluded in order to concentrate on the long wave UV light. This is achieved by applying short-pass filters and using exclusively UV light sources.

Channel	Filter type	Annotation
1	SP 400	UV reflectography
2	LP 400	VIS-IR
3	BP 450	VIS-IR
4	BP 550	VIS-IR
5	BP 650	VIS-IR
6	BP 780	VIS-IR
7	LP 800	IR reflectography
8	RGB	VIS-IR

Table 1: Description of the multi-spectral images containing the channel number, the filter type and the methodology of the image acquisition. LPF depicts a long-pass filter, SPF a short-pass filter and BPF is a band-pass filter.

Seven filters allow the recording of the document pages in seven different bands ranging from 330 - 1000 nm. Table 1 shows the filters which were used to take seven spectral images. Additionally, a RGB color image and a UV fluorescence image of each manuscript page are taken using a Nikon D2Xs camera. Due to the automatic image acquisition system the registration of the images is solely needed for the correction of the differing distortions caused by the filter changes. Therefore, a simple correlation based approach and a consecutive local transformation can be applied. Since the grayscale images,

taken in varying bands with the Hamamatsu camera system, shall be aligned to the color images taken with the Nikon camera, a more extensive registration method needs to be implemented. Calibrating both cameras to each other would have facilitated an image acquisition where no subsequent registration is needed. Nevertheless, the system needed to be as small as possible and robust due to the transport to the Mt. Sinai.

Figure 2 shows the acquisition system where the Hamamatsu camera is used to capture seven spectral images (grayscale). Having acquired the spectral images, the manuscript pages need to be moved in order to capture RGB images with the Nikon camera.

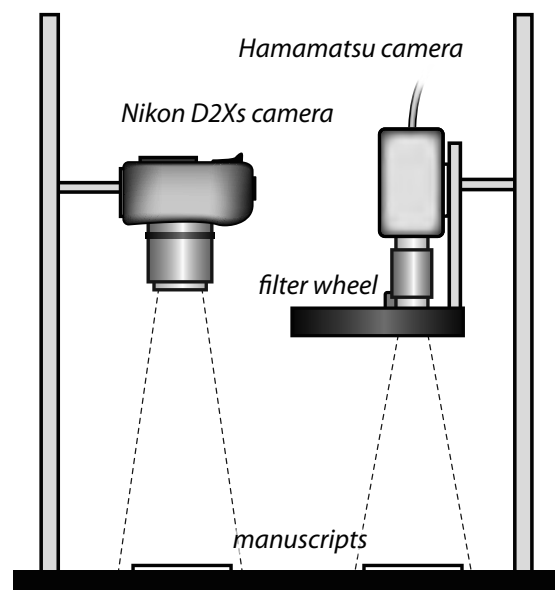

Figure 2: Illustration of the acquisition system, with the Hamamatsu and the Nikon camera.

4. IMAGE REGISTRATION

A coarse-to-fine approach is used to register images taken with different cameras. Thus, global distortions such as changes in rotation, scale or translation are estimated using a feature based approach and an affine transformation matrix. Local distortions resulting from different page curvatures are estimated by the computation of the cross correlation between the reference image and the coarsely aligned sensed images taken with a Nikon camera. Additionally, the spectral images taken with a Hamamatsu camera are aligned to each other using the cross correlation and an affine transformation. Figure 3 clarifies how the images of one manuscript page are aligned to each other. All gray pages illustrate sensed images which are aligned to the reference image (bold border).

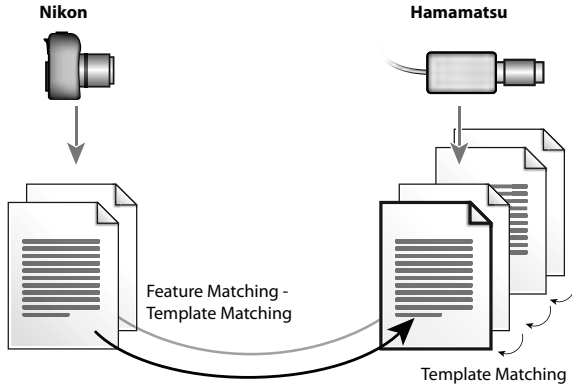

Figure 3: Illustration of the methods used to align the images to each other.

4.1 Coarse Registration

The features, used to register the images coarsely, are computed similar to the Scale Invariant Feature Transform (SIFT) (Lowe, 2004). Since the computation of the scale-space needed for the SIFT approach is computationally expensive and the size of the objects is similar in different images, the scale-space is not computed in our approach. Thus, each control point detected has the same scale. It turned out, that the Difference-of-Gaussians (DoG) detects too many local extrema for a registration task. In a 391 x 493 px sample image approximately 5000 control points are detected. Considering that the transformation is accurate enough if approximately 250 matches are used for the parameter estimation (since four matches are needed to compute the transformation matrix). Hence, the control points are localized using the Harris Corner Detector (Harris & Stephens, 1987). It detects less control points with the same scale parameter α than the DoG approach.

The orientation assigned to each control point is computed similar to Lowe's implementation (Lowe, 2004). First the image gradient magnitude $m(x, y)$ and the orientation $\theta(x, y)$ are computed for each pixel of the smoothed image $L(x, y)$.

$$m(x, y) = \sqrt{(L(x+1, y) - L(x-1, y))^2 + \dots + (L(x, y+1) - L(x, y-1))^2} \quad (1)$$

$$\theta(x, y) = \tan^{-1} \left(\frac{L(x, y+1) - L(x, y-1)}{L(x+1, y) - L(x-1, y)} \right) \quad (2)$$

An orientation histogram with 36 bins corresponding to 360° is created. Each sample added to the histogram is weighted by its gradient magnitude and a Gaussian weight. Afterwards, the histogram is smoothed with a Gaussian kernel. The maximum of the histogram indicates the dominant direction of local gradients. In order to compute a local descriptor that characterizes each control point the image gradients $m(x, y)$ and the orientations $\theta(x, y)$ in a 16 x 16 px window around each control point are considered.

After the features are computed for both images, they are matched using the nearest-neighbor algorithm. Since a control point may exist solely in one of the two images, corresponding control points are rejected if their distance to the nearest-neighbor is less than 0.8 times the distance to the second-nearest neighbor. Control points which have more than one correspondence are discarded too. Having discarded the control points according to this scheme approximately 200 corresponding control points are left for an image with 391 x 493 px.

Since false matches can exist after discarding the previously mentioned control points and one outlier changes the transformation estimation of the Least Squares Solution dramatically, the RANSAC method is used to discard all remaining outliers (Fischler & Bolles, 1981). This approach computes the affine transformation using three randomly selected matching points. Having tested all remaining control point pairs, the model is re-estimated from the entire set of hypothetical inliers. These steps are repeated until the distances between points and the model meet a given threshold. This method discards in our approach approximately 8.3% of the matching control points. Afterwards, an affine transformation matrix is computed using the Least Squares Solution.

4.2 Cross Correlation

Having aligned the two images coarsely using adapted SIFT features and a global affine mapping function, a normalized cross correlation is computed at the locations of the previously found control points. The aim of the cross correlation and the subsequent local mapping function is to correct non-linear distortions caused by changing page curvatures. The manuscripts captured were partially placed on tissue in order to protect them against damages. Since this tissue has a self similar pattern and changes in position relative to the manuscript page, the cross correlation detects false similarities. That is why a simple segmentation of each page is performed before computing the cross correlation. Therefore the image is convolved with a Gaussian filter kernel ($\sigma = 2$) so that noise is suppressed. Subsequently the image is thresholded with a global Otsu threshold. After objects which are smaller than 10% of the image area are removed, the holes of the remaining objects are filled. This segmentation does not always segment the pages perfectly but it is a fast and good foreground estimation. Finally all keypoints which are within the segmented page are taken into account for the cross correlation.

4.3 Local Transformation

Having determined the control points, the parameters of the mapping function are computed. Images which possess only global distortions (e.g. rotation) may be registered with a global mapping function. As a consequence of non-linear distortions such as the changing of lenses or curvature of a single page, the images have to be registered using a curved transformation.

The local weighted mean method (Goshtasby, 1988) is a local sensitive interpolation method. It requires at least 6 control points which should be spread uniformly over the entire image. Polynomials are computed by means of the control points. A weighting function is defined which guarantees that solely polynomials near an arbitrary point influence its transformation. The weighting function of the polynomials $f_i(x, y)$ for an arbitrary point (x, y) is defined by:

$$W_i(R) = \begin{cases} 1 - 3R^2 + 2R^3 & 0 \leq R \leq 1 \\ 0 & R > 1 \end{cases} \quad (3)$$

Where R is the normalized Euclidean distance between a point (x, y) and a control point (x_i, y_i) . Thus, the transformation of an arbitrary point $f(x, y)$ is computed by the weighted mean of all passing polynomials whose weight is greater than zero:

$$f(x, y) = \frac{\sum_{i=1}^n W_i(R) P_i(x, y)}{\sum_{i=1}^n W_i(R)} \quad (4)$$

Where $W_i(R)$ is the weight of the i -th polynomial and $P_i(x, y)$ is the i -th polynomial.

Tests showed that 22 control points are a good trade-off between accuracy and performance. In order to spread candidate control points uniformly over the entire image and to guarantee that approximately 22 control points are computed for the parameter estimation of the local weighted mean transformation, a minimum distance constraint is implemented. Hence, the distance between each candidate control point and all previously matched control points needs to be greater than 12.5% of the minor image axis.

5. RESULTS

Having discussed the implemented methods, their results are presented in this section. Both, the modified scale-invariant features and the normalized cross correlation have been tested on real manuscript images. Results of the methods are presented in Figure 5 - 6 and Table 4 and 7.

Filter Type	N	Mean	Std	Max
(Nikon) VIS	5	0.06	± 0.091	0.48
(Hamamatsu) VIS	2	0.06	± 0.129	0.69
LPF 400	2	0.07	± 0.089	0.43
SPF 400	2	0.02	± 0.024	0.11
BPF 450	4	0.08	± 0.127	0.84
BPF 550	2	0.09	± 0.148	0.87
BPF 650	2	0.05	± 0.068	0.32
BPF 780	2	0.04	± 0.061	0.33
LPF 800	1	0.05	± 0.062	0.27

Table 4: Mean and Max error of the rotation angle in°.

In addition to tests with real image data, the invariance against rotation of the coarse registration is evaluated. Therefore 22 image details of all spectral bands are taken into account. Each test image is rotated 30 times ($0^\circ, 12^\circ, 24^\circ, \dots$) which results in a total of 660 tests. Thus, the rotation between the test image pairs is known. Afterwards the affine transformation model is estimated using the modified SIFT approach. The resultant maximal error is 0.87° and the minimal error is approximately 0° (exactly: 1.44×10^{-15}). The mean error of all 660 tests is 0.06° . Figure 5 shows the minimum, maximum and mean error for each sampled angle. The two peaks in all lines are near 90° and 270° . This attributes to the maximal interpolation error which

increases before it is zero at $0^\circ, 90^\circ, 180^\circ$ and 270° . Additionally the mean error with its corresponding standard deviation and the maximal error for each spectral image are given in Table 4 (SPF = short-pass Filter, LPF = long-pass Filter, BPF = band-pass Filter, VIS = No Filter). The column N indicates how many image details were taken into account for each group of spectral images. It can be seen that the images captured with a short-pass filter at 400 nm are the best input images for the coarse registration. In contrast, images captured with a band-pass filter at 450 nm and 550 nm have the highest rotational error.

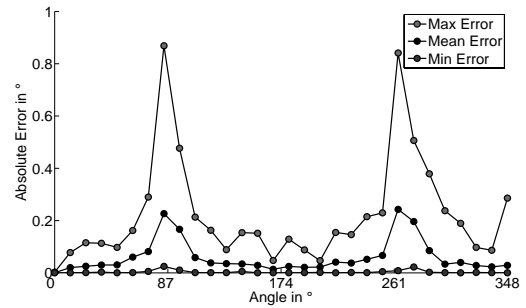

Figure 5: The maximal, minimal and mean error for each sampled angle.

The affine transformation, estimated with the modified SIFT approach (Figure 6a), and the local weighted mean method (Figure 6b) are compared to each other using spectral and RGB images. Since the images possess local nonlinear distortions, only certain parts of the registered images correspond if an affine mapping function is applied. Hence, the farther the points are away from the corresponding area, the more they differ. That is why a local sensitive mapping function is applied to compute the transformation after the images are coarsely aligned with an affine transformation. Erroneous pixels still exist in the final image. These attribute to the changing shadows caused by the changing page curvature and illumination due to the shifting of the book between the takings.

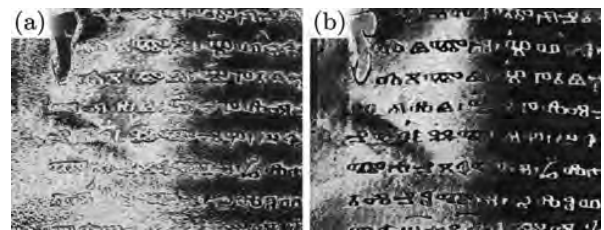

Figure 6: Difference image of two registered images.

In addition to the previously mentioned tests, the performance of the image registration was tested on all manuscript images taken at the Mt. Sinai. In order to classify the resulting images, they were classified into correct/wrong visually. The results of this final control are given in Table 7.

Description	Correct (in %)	Total Number
Hamamatsu	100%	1144
Nikon	94.9%	158
Nikon (2 nd pass)	98.7%	158
Total	99.4%	1302

Table 7: Results of the final registration on real images.

6. CONCLUSION

A fully automatic registration, aligning two different images with each other, was depicted. The registration is split into a coarse and a fine registration part. Thus, minor displacements caused by filter changes can be corrected with the cross correlation which is faster than computing local features. Besides discussing the proposed registration approach, the methods were tested on real images. Additionally, numerical results of the coarse registrations accuracy were given in Section 5.

In combination with a script which lets the user specify which filename should be used as reference image, it was possible to register the images taken of the Cod. Sin. Slav 5N without human interaction. After fine tuning parameters of the fine registration (Nikon 2nd pass), solely one image could not be registered with the proposed method. There, the manuscript page is partially disrupted and the angle changes between the images. Hence, more than 20 control points would be needed to compensate these local distortions.

The strength of the proposed approach is the absence of the need for human interaction and manual corrections. While at the same time compensating affine and local non-rigid distortions. A weakness of the method is that it was designed especially for the registration of manuscript images. Hence, it needs to be modified for general image registration tasks.

7. REFERENCES

References from Journals:

Balas, C., Papadakis, V., Papadakis, N., Papadakis, A., Vazgiouraki, E., & Themelis, G., 2003. A novel hyper-spectral imaging apparatus for the non-destructive analysis of objects of artistic and historic value. *Journal of Cultural Heritage*, 4, 330–337.

Fischler, M. A. & Bolles, R. C., 1981. Random sample consensus: a paradigm for model fitting with applications to image analysis and automated cartography. *Communications of the ACM*, 24(6), 381–395.

Goshtasby, A., 1988. Image registration by local approximation methods. *Image and Vision Computing*, 6, 255–261.

Lowe, D. G., 2004. Distinctive image features from scale-invariant keypoints. *International Journal of Computer Vision*, 60(2), 91–110.

Zitová, B. & Flusser, J., 2003. Image registration methods: a survey. *Image and Vision Computing*, 21, 977–1000.

Zitová, B., Flusser, J., & Sroubek, F., 2004. An application of image processing in the medieval mosaic conservation. *Pattern Anal. Appl.*, 7(1), 18–25

References from Books:

Mairinger, F., 2003. Strahlenuntersuchung an Kunstwerken. E. A. Seemann Verlag.

References from Conferences:

Cappellini, V., Mastio, A. D., Rosa, A. D., Piva, A., Pelagotti, A., & Yamani, H. E., 2005. An automatic registration algorithm for cultural heritage images. In *ICIP (2)*. 566–569.

Easton, R. L., Knox, K. T., & Christens-Barry, W. A., 2003. Multi-spectral imaging of the Archimedes palimpsest. In *32nd Applied Image Pattern Recognition Workshop, AIPR 2003*. Washington, DC: IEEE Computer Society, 111–118.

Harris, C. & Stephens, M., 1987. A Combined Corner and Edge Detector. In *4th Alvey Vision Conference*. 147–151.

Rapantzikos, K. & Balas, C., 2005. Hyper-spectral imaging: potential in non-destructive analysis of palimpsests. *International Conference on Image Processing, ICIP 2005*, 2, 618–621.

Viola, P. A., William, M. & Wells. I., 1995. Alignment by maximization of mutual information. In *ICCV*. 16–23.

8. ACKNOWLEDGEMENTS

This work was supported by the Austrian Science Foundation (FWF) under grant P19608-G12.

DESIGNING “TYPICAL KNOWLEDGE” REPERTOIRES. THE CASE OF CHINESE INTANGIBLE HERITAGE “ACTIVE-ACTION”

E. Lupo^a

^a Dept. Indaco (industrial design, art and communication), Politecnico di Milano, Via Durando 38/A 20158 Milano –
eleonora.lupo@polimi.it

KEY WORDS: Intangible heritage, Living archive, Knowledge e-repertoires, Narrative technologies

ABSTRACT:

This short paper will present the preliminary hypothesis for a work in progress project focused on design processes for the recognition, understanding and exploitation of Chinese intangible heritage through the development of narrative and participative modalities of “active-action” supported by interactive technologies. The project will be developed within the Asian Lifestyle Design Lab in Hong Kong School of design. The concept of intangible heritage assumed by the project, according with the Unesco Convention for safeguarding of intangible heritage (Unesco, 2003) is a kind of distributed knowledge, often not represented or manifested in distinctive or emerging and spectacular forms but considerable a valuable expression of typical creativity embodied in people, rooted in activities and places and defined as “typical knowledge”. Due to its process nature of “performance embodied in people” (Kishenblatt Gimblett, 2004), in order to be preserved, the typical knowledge needs to be continuously performed, taught and socialised, in other words, “activated”. So the project works in the design of a living/activating archive system about Chinese intangible heritage, conceived as an interactive and accessible repertoire of knowledge, that is an open archive to which people can contribute, and will enable the establishment of a diffused knowledge embodied in persons, practices and artefacts about those heritage. In fact the system will support, through strategies like story telling and apprenticeship, the direct fruition and experience by persons of selected Chinese living heritage, promoting its deep awareness, comprehension and interpretation: this appropriation by people will guarantee the learning and transmission to the future generations of this intangible heritage thanks to a new human living repository (as the UNESCO living human treasures) of such knowledge and related practices. Then the system will experiment other modalities to spread the archive out of the archive and will activate the typical Chinese knowledge creating a sort of distributed knowledge embodied in new artefacts, pursuing its not simplified incorporation in the design of new solutions that include products, services, and strategies more consciously culture oriented.

1. INTRODUCTION

This research project aims to establish and develop design processes, strategies, methodologies and tools for Intangible Cultural Heritage understanding and exploitation specifically addressed to the Chinese living heritage.

Intangible heritage is defined as practices, representations, expressions, knowledge, skills – as well as the instruments, objects, artefacts and cultural spaces associated therewith - that communities, groups and, in some cases, individuals recognize as part of their cultural heritage and it is considered by UNESCO as an invaluable factor in bringing human beings closer together and ensuring exchange and understanding among them (UNESCO Convention, 2003). For this reason, the intangible patrimony needs to be identified and preserved for the transmission to the next generations. Beside this, we state also that Intangible cultural Heritage can become a dimension for sustainable (social, cultural and economical) development and it should be more integrated in the contemporary cultural and productive systems to generate local development in terms of services, cultural offer and enterprises connected in a deeper way with the territorial identity (Greffé, 2005). The research hypothesis is that design approach improves culture understanding by providing the necessary tools, infrastructures, technologies and services to enable its comprehension and use, and by translating the heterogeneous resources represented by living heritages in innovative scenarios, designing real actions of exploitation of the knowledge they represent.

Chinese contemporary living heritage will become the prototype of a design process of recognition, understanding and exploitation of the Intangible cultural Heritage. By one hand, the design actions will be directed to a proper identification and documentation of the Chinese intangible heritage in order both to collect a basic knowledge of it and to start an appropriate process of preservation and protection of such meaningful aspects whose existence is in some way compromised or unknown. By the other hand the design activity will be addressed to the promotion, enhancement, transmission, as well as the revitalization of the various aspects of such intangible heritage. The exploitation of the Chinese heritage involves two different distributed processes of active-action (use and fruition) of the knowledge gathered: the first one is addressed to design strategies and systems enabling its fruition and experience directly by persons as a way to reflect about heritage, culture and identity; the second one means mainly a deep process of analysis, understanding and comprehension of this cultural values, still existing in the contemporary communities behaviours, and their not simplified incorporation in the design of new solutions (extending widely the concept of products and services) more consciously culture oriented which borrow and refine the process nature of performance embodied in people (Kishenblatt Gimblett, 2004) typical of the Intangible Heritage.

The project will be developed in strong connection with the Asian Lifestyle Design Lab of Hong Kong Polytechnic School of design, starting from September 2008.

2. THE THEORETICAL BACKGROUND

2.1 A PhD research on design strategies for cultural heritage active-action

During the years 2004-2007 a PhD research, “The valorisation of cultural heritage as a design driven process” has been carried out within the design department of Politecnico, Milano. The doctoral research has been focused on defining the innovative role of design as strategic and user centred approach in Cultural Heritage value enhancing, to enable both culture fruition and experience by persons and culture based development.

The basic knowledge developed during the PhD research about Cultural Heritage design strategies was carried out with a phenomenological approach, based upon the collection of paradigmatic projects, in order to establish the design role in cultural heritage valorisation, giving evidence to the design competences already existing and producing a systematic theoretical background and a reference frame of best practices. The practice of action research was, in the meantime, the method used to verify and validate the design processes hypothesis. Training in ‘situated’ research has been particularly challenging in Cultural Heritage, since many competences and professionals are traditionally involved in order to manage the Cultural patrimony, generating a very complex and trans-disciplinary multi-actor system. Nevertheless, the collaborative and participative dimension of the action-research, facilitated the agreement and the sharing of knowledge among the diverse professionals involved and helped to reduce the gap between the conservation theory and the valorisation praxis.

During both those activities, design organisational and conceptual visualisation methods have been adopted, setting them with a *relational* attitude: in order to define a standard for a design oriented process of valorisation, the multidimensional phenomenon of Cultural Heritage valorisation has been extremely synthesized in a *relational processes model* through an enriched conceptual and “visual” model, extending the possible design interventions and making the strategic role played by design easier to understand and apply. This model place the cultural heritage in a system of goods, deeply connected with the context where is located or has been originated (not only a physical context but also a symbolic one) and the community who owns, manages or experiences it.



Figure 1: The design relational model of CH

According to some results of that PhD, the subject of Intangible Heritage has been recognised as a new emerging knowledge

field for the design research and practice processes¹ and has been selected for further implementation with the objective of identifying and verifying proper design professional methodologies in this field and of designing systems and platforms to make dialog the valorisation of Intangible heritage of some specifically selected territories and local communities with the global economic system.

Therefore, the project under development within the Asian lifestyle design lab of Hong Kong Polytechnic School of design will apply the same operational methodology to the concept of Chinese intangible Heritage: initially, the intangible heritage analysed has been chosen among the UNESCO Masterpieces², which includes mainly traditional heritage.



Figure 3: Unesco masterpiece website

But the same approach has been re-addressed to any other living heritage: in the identification action of the Intangible heritage, which is very often a value legitimating process, the ancientness of the patrimony is not any more a discriminating factor. In fact as stated by Unesco, are the rareness and uniqueness, together with its vitality, which lead to consider the contemporary expressions as an heritage suitable of safeguarding measures.

So, our definition of intangible heritage refers to a complex concept, including both such traditional ambits as rituals and social behaviors, values, oral expressions, and other intangible aspects which are not immediately perceived or recognized as conventional heritage but are fundamental in shaping the form of artifacts, products, structure of society and organization of work. Those kinds of distributed heritage is often not represented or manifested in distinctive or emerging spectacular forms but is a valuable expression of typical creativity embodied in people, rooted in activities and places and can be defined as “typical knowledge”.

2.2 The “problem” of safeguarding the typical knowledge

The typical knowledge is a crucial factor for local cultural identity and a key issue for sustainable development. Intangible cultural heritage is considered as mentioned above “an invaluable factor in bringing human beings closer together” and can become a dimension for sustainable (social, cultural and economical) development.

¹ See Lupo E., *Intangible Cultural Heritage valorisation: a new field for design research and practice*, in IASDR07 conference proceedings *Emerging trends in design research*, School of Design (ed. by), Hong Kong Polytechnic University, Hong Kong, 2007.

² <http://www.unesco.org/culture/en/masterpieces/>

In the contemporary world, the existence of such typical knowledge and traditions, is not granted for always because the globalisation doesn't help for a proper process of the value legitimating: sometimes its existence leads to underestimate its value, or more often, the act of safeguarding becomes integralism and drives to a static and philological conservation. In our hypothesis, the intangible heritage safeguarding is context oriented: the relation with a local context is, for the cultural heritage, a dimension of sense making and value generation. In the same way, the typical knowledge is always localized too, which means it is the result of specific local conditions and its experience and use by people will always happen in a specific place and time. And, in addition, a deep connection with the context is very often for this kind intangible cultural heritage one of the reasons preventing its disappearing: a typical knowledge usually can survive until it is required by the context where it has originated from.

So, there are three dimensions for the typical knowledge safeguarding: localisation, territorialisation and contextualization. The first one corresponds to the link with the physical dimension (a place), easily recognizable, where the knowledge has been generated from and which determines its opportunity of fruition and dissemination. However, the context is not considered only as a physical localization, but the natural, environmental, cultural and territorial conditions which determinate the form of the heritage: the link with that context and with its characteristics is important especially in the process of understanding the origins and the nature of the knowledge and its further development.

The territorialisation is a process in which the heritage spreads its relation with the context in a system of horizontal relations with other heritages and human activities. In fact, the typical knowledge is a living entity and this means it has to be constantly recreated and transmitted in order to be preserved by extinction and these dynamics makes it evolving and transforming during the time. According to Kirshenblatt Gimblett (2004), the typical knowledge "is not dividable from the person who owns it and is passed on through performance". Through these performances the typical knowledge becomes territorialized. While the process of localization is somehow natural, the territorialisation is an act of organization aiming at connecting the typical knowledge together and therefore is subject to be designed.

The contextualization of a typical knowledge is that complex design process that resides mainly in a deliberate reconstruction (physical or symbolic) of a vertical relationship between the knowledge and a context. In fact, the territorialisation process makes the typical knowledge interact with the surrounding environment, its dynamics of exchange, production and fruition and cannot be separate by them: if the context change, the knowledge is often destined to become marginal or disappear or to adapt itself to the changed context trying to preserve its specificities. Therefore, in order to properly preserve a typical knowledge according to its process nature and to the deep and continuous changes of the contemporary world, is necessary to transform and adapt the knowledge, integrating it within the changed context or embedding it directly in a new context: when this link with the original loosens or breaks, the exploitation process tries to rebuilt it or to make it understandable for people, revealing the link with its original place or setting the knowledge in an comprehensible frame and in a proper context for who is experiencing it, linking

traditional meanings with new interpretations in a new place of experience, fruition and application.

This is what we call active-action of a typical knowledge: it's a negotiation process, that considers the typical knowledge a living entity that can be activated in continuity with its traditional features and meaning, but enabling it to dialog with the contemporary context and innovative applications, finding a new balance between uniqueness and repeatability of its skills, practices and techniques, in forms and numbers of relations which the heritage can face, avoiding any compromising distortion of its nature and the loss of its inner and symbolic value.

And these three active-action processes can be excellently supported by multimedia and interactive technologies.

3. THE PROJECT

3.1 The objective

Within the Asian lifestyle design lab in Hong Kong School of design, this research project will contribute first to the definition of a repeatable design process and methodology of documenting and analysing the Chinese living heritage, second to the development of a living and learning archive about the knowledge on Chinese intangible heritage, third to the exploitation and revitalisation of this knowledge in new culturally aware design solutions.

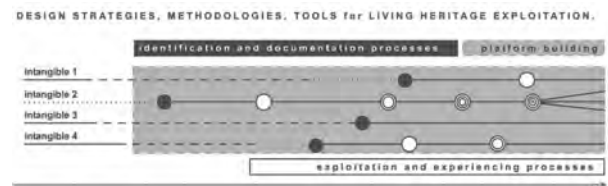

Figure 3: The design process of IH exploitation

The result will be an interactive and accessible *repertoire of knowledge*, that is an open archive to which people can contribute, and will enable the establishment of a diffused knowledge embodied in persons, practices and artefacts about those heritage.

3.2 The rationale

For the methodological aspects, this project overviews and points out some constant and recurring methods, tools and techniques, of possible approach of design practice in this field derived from a systematic qualitative analysis and evaluation of emblematic case studies. As one of the expected results, will be hypothesized a model representation of the design processes for the Chinese Intangible Heritage valorisation, implementing some design specificities like the sharing of knowledge between the actors involved in the process, the centrality of the user and the generation of innovation both in forms of experiences and social meanings and in the products-services technological systems.

Beside to this methodological background the project will work from the beginning in the development of a living archive about Chinese intangible heritage.

Concerning the design of the archiving modalities, a living heritage leads to question the traditional approaches. The Chinese knowledge, traditions, behaviours, even if they appear physically in objects or products, have an immaterial form whose documenting process is fundamental. It's often easier to save the physical product of a culture (for instance a handcraft object), but saving all information related to the context, the handcraft abilities and techniques it's ever more complex. The Chinese intangible heritage is strictly connected with the traditional material cultural heritage: in fact we have, by one hand, oral traditions and expressions, which are forms of collective and agreed knowledge without a physical appearance, but which determinate tangible attributes of life, like behaviours, activities and their material supports; on the other hand we should include the immaterial value of physical objects, products and artefacts, which concerns the needed skills for their use, and their symbolic meaning. Some homogeneous categories have been proposed for the identification of the Chinese typical knowledge:

- productive knowledge (art and handcraft products, traditional recipes, gastronomic products);
- relational knowledge (celebrations, rites, customs, popular and religious feasts and manifestations);
- reproductive knowledge (art, music, theatre expressions, languages);
- living human treasures (knowledge owners).



Figure 4: The Guqin and its Music (Chinese Intangible Heritage masterpieces)

The project hypothesizes an archiving process not separated from the fruition modalities in which the recording phase includes the fundamental phase of exploitation: in fact the typical knowledge needs to be continuously taught to ensure its own existence and not simply catalogued, and implies proper methodologies, innovative strategies, tools, techniques and technologies aiming both to its conservation and documentation and to its transmission and fruition.

The processes of such Chinese knowledge learning and reproduction will be designed embedding more participation in the process, with a result that can be assimilated to a repertoire of knowledge which takes in account its inclination to be a performance embodied in people. For this reason, this multimedia and visual e-repository will consist in a collaborative process of knowledge sharing between the owner, the designer and the future users, shaped by local culture, attitudes and behaviours. The research will experiment new

participated and narrative modalities will use media technologies like the web 2.0. This e-repository of knowledge about Chinese living heritage will be intended as a living and learning archive in which multimedia and interactive technologies effectively support the participative and interactive documentation and fruition processes of valorisation of Intangible cultural heritage, and will constitute the base for a future common history. A reference can be visualised in the web tool...

Concerning the exploitation activity of the living archive, it has been theoretically divided in different time overlapping phases. In the meantime of the implementation of the archiving process, short run actions of communication and use of the first gathered knowledge will be designed. These are meant to visible support the development of the facilitation platform planned by the Asian life style lab and to exemplify some of the final potential application and facilities of the Knowledge centre.

In the same time, some pilot exploitation applications will be designed.

3.3 The pilot applications

The first exploitation pilot application will be aimed to design strategies and systems enabling the direct fruition and experience by persons through the archive of selected Chinese living heritage, promoting its deep comprehension and interpretation. Those strategies will be supported, for instance, by narrative and participative modalities like story telling and apprenticeship. This interpretation and appropriation will guarantee the learning and transmission of this intangible heritage through a new human living repository (as the UNESCO living human treasures) of such knowledge. The idea is to experiment modalities to spread the archive out of the archive and to create a sort of distributed knowledge embodied in people: beside the traditional digital archive there will be an open archive to which people can contribute, and a living archive embodied in persons, in a continuous feedback between digital and analogical knowledge.



Figure 5: A living repository of knowledge

The second exploitation pilot application will be focused on the incorporation of such heritage characteristics in new design solutions that include products, services, strategies. This means the design of an enabling platform capable to re-activate the Chinese typical knowledge and apply it to new products and services, but taking in account the continuity with its "tradition". The platform will enable some flexible and adaptable (concerning the specificity of different heritages) but repeatable actions aimed at building sustainable relations among the heritage and the contemporary global context and market. This process, at the same time, should generate favourable conditions for the community to control, enhance and take advantages, also economically, of the intangible heritage they own avoiding their heritage spoliation. So, the impact produced by the platform will positively affect both the

economic and productive (new valuable solutions) and the social systems (new aware communities).

For both of the pilot projects the practice of the *design workshop* will be used to experience and learn how to use the Chinese typical knowledge by people and enterprises, developing concepts inspired by Chinese intangible heritage in partnership with industries and heritage owners themselves: the design, thanks to its ability to deeply observe and analyse user contexts and people behaviours will act in the process as a translator of the symbolic, hidden meanings of the Chinese living heritage, mediating their understanding for industries and visualizing reliable and innovative scenarios of re-use, industrialisation, production and exploitation.

4. REFERENCES

Corte-Real, E., Duarte, A. M. C., Carvalho Rodrigues, F., editors. 2005. *Pride and predesign. The cultural Heritage and the science of design*, Conference proceedings. Unidicom-IADE, Lisbon

EUROPEAN COMMISSION, Office de coopération EuropeAid, editor. 2007. *Strategy for the development of Euro-Mediterranean cultural heritage: priorities from Mediterranean countries (2007–2013)*. Bruxelles

Flusser, V. 2003. *Filosofia del design*. Bruno Mondadori, Milano

Grefe, X. 2005. *Cultura e sviluppo locale*. Nicolodi, Trento

Grefe, X., Pflieger, S., editors. 2005. *Culture and local development*. OCSE-OECD Publishing, Paris

Kirshenblatt Gimblett, B. 2004. *Intangible heritage as metacultural production*. *Museum International* 56: 52-64

Lupo, E. 2007. "Intangible Heritage valorisation: a new field for design research and practice" in *Emerging trends in design research*. ed., Honk Kong Polytechnic University. Hong Kong Polytechnic University Press, Hong Kong

Lupo, E. 2007. *La valorizzazione dei beni culturali come processo di design. Casi, metodologie, strumenti*. Polipress-Politecnico di Milano editore, Milano

UNESCO. 2003. *Convention for the Safeguarding of the Intangible Cultural Heritage*

BUILDING THE ENCYCLOPEDIA OF LIFE

Graham Higley, Natural History Museum, Cromwell Road, London SW7 5 BD United Kingdom g.higley@nhm.ac.uk

KEY WORDS: EOL, species pages, biology, zoology, botany, education, portal

ABSTRACT:

The Encyclopedia of Life (EOL) is an unprecedented global effort to document all 1.8 million named species of animals, plants, and other forms of life on Earth. For the first time, scientists, students, and citizens will have multimedia access to all known living species, even those that have just been discovered. The Field Museum of Chicago, Harvard University, Marine Biological Laboratory, Smithsonian Institution, Missouri Botanical Garden, and Biodiversity Heritage Library together initiated this project, bringing together species and software experts from across the world. The project has raised \$50M already, including \$25M from the MacArthur and Sloan Foundations. Over the next 10 years, the EOL will create Internet sites for all 1.8 million species currently named. It will expedite the classification of the millions of undiscovered and uncatalogued species. The pages (www.eol.org) will provide written information and, when available, photographs, video, sound, location maps, and other multimedia information on each species. Built on the scientific integrity of thousands of experts around the globe, the EOL will be a moderated Wiki-style environment, freely available to all users everywhere. Ultimately, the EOL will provide users the opportunity to personalize the learning experience through its “MyEOL” feature. The site will be made available in all major languages and will connect scientific communities concerned with ants to apples to zebras. As part of its work, the EOL will collaborate and partner with a wide range of organizations, individuals, and experts to help strengthen its content and its impact on communities throughout the world.

1. ENCYCLOPEDIA OF LIFE

“Imagine an electronic page for each species of organism on Earth, available everywhere by single access on command. The page contains the scientific name of the species, a pictorial or genomic presentation of the primary type specimen on which its name is based, and a summary of its diagnostic traits. The page opens out directly or by linking to other databases, such as ARKive, Ecoport, GenBank, and MORPHOBANK. It comprises a summary of everything known about the species’ genome, proteome, geographical distribution, phylogenetic position, habitat, ecological relationships and, not least, its perceived practical importance for humanity...”

The page is indefinitely expansible. Its contents are continuously peer reviewed and updated with new information. All the pages together form an encyclopedia, the content of which is the totality of comparative biology”.

E O Wilson (Wilson, 2003)

Human activities pose an ever-growing threat to biological diversity. Population growth, global climate change and other environmental perturbations heighten the urgency with which we must discover, understand, and protect the world’s species of living organisms. At the same time, the general public shows increasing interest in biodiversity and support for efforts to preserve it. In an attempt to respond to these imperatives, in May 2007 representatives of several of the world’s leading natural history institutions, with initial financial support from two major private foundations, joined together to create the Encyclopedia of Life (EOL).

The EOL will dynamically synthesize biodiversity knowledge about all known species, including their taxonomy, geographic distribution, specimens in collections, genetics, evolutionary history, morphology, behaviour, ecological relationships, and importance for human wellbeing, and distribute this information freely through the Internet. It will serve as a primary resource for a wide audience that includes scientists, natural resource managers, conservationists, teachers, and students around the world. The EOL’s wide scope and innovation will have a major global impact in facilitating biodiversity research, conservation, and education. Many countries, especially those in the

developing world, regard biodiversity as an important element in their economic and societal development. The EOL will facilitate access to biodiversity information in the countries where most of the planet’s biodiversity is found and where it must be managed sustainably.

The work required to assemble and manage the EOL is organized into a series of five components groups, which is hosted by one or more institutions. As these activities increase in scale and scope, additional host institutions and other partner organizations, as well as new working groups, will be added.

1.1 Species Sites

Online “species sites” will form the core of the EOL (Figure 1 shows a typical page). Individual sites will be assembled for each of the approximately 1.8 million named species of living organisms. Each site will consist of an entry-level species page, designed for the general public, and more specialized pages for particular audiences. More species sites will be added as new species are discovered and named. The Species Sites Group will:

- Design the “look and feel” of the site, and determine the recommended contents for entry-level species pages
- Seek content from potential data providers and users, by engaging with professional scientists, citizen scientists, and skilled amateurs.
- Develop protocols for authenticating information on entry-level species pages. Experts on particular taxonomic groups will be invited to serve as “curators” to ensure that information is correct and current.
- Implement a robust intellectual property regime. To the greatest extent possible, data provided through the EOL will be freely available for all to use. Some data providers may limit the reuse of information they provide.
- Develop focussed portals for different audiences. Such as, an educators’ portal that might provide access to special tools for classroom instruction or field trips, or a birdwatchers portal that could showcase behaviour of local species.

HOME
PREFERENCES
LANGUAGE: EN
FEEDBACK
PRESS ROOM
USING THE SITE
ABOUT EOL

You are not logged in. Please [login](#) or [create an account](#).

[Help me find more species](#)

GREEN ANOLE

Anolis carolinensis

IUCN RED LIST STATUS: LEAST CONCERN (LC)

IMAGES
MAPS

IMAGES

CLASSIFICATION
TEXT
GRAPHIC
SOURCE

- Animals +
- Chordates +
- Reptiles +
- Amphisbaenians +
- Anoleid lizards +
- Coffee Anole +
- Green anole -
 - [Anolis carolinensis subsp. carolinensis](#)
 - [Anolis carolinensis subsp. coarctatus](#)
- Archaea +
- Bacteria +
- Chromista +
- Fungi +
- Plants +
- Protozoa +
- Viruses +

LESS
DETAIL
MORE

OVERVIEW

EXPLORE

TABLE OF CONTENTS

- Overview
- Description
 - Physical Description
 - Locand
 - Molecular Biology and Genetics
 - Identification
 - Specimen Information
 - Original Description
 - Physiology and Biochemistry
 - Reproduction and Life History
- Ecology and Distribution
 - Distribution
 - Habitat
 - Ecological Determinants/Niches
 - Life History
- Conservation
- Evolution and Systematics
 - Classification
 - Paleontology
 - Concepts and Synonymy
 - Catalogue of Life Synonyms
- Relevance
 - Domestication
- Biodiversity Heritage Library
- References and More Information
 - Literature References
 - People
 - Editors Links
 - Specialist Projects
 - Interesting Facts
 - Common Names

SOURCE AND ADDITIONAL INFORMATION

S. Tonia Hsieh
Some rights reserved

The green anole or Carolina anole (*Anolis carolinensis*) is common in pet stores where it is sometimes identified as the American chameleon because of its ability to change color from green to brown. It is important to note, though, that these lizards are not actually a type of chameleon. Green anoles are the only anole lizard native to North America, and are found primarily in the southeastern United States, with recent introductions to Hawaii, Guam, and elsewhere. They are very common throughout their distribution, typically found on the sides of buildings, on shrubs or vines, and high in trees. They periodically are also found on the ground. As their name suggests, these lizards are emerald green in color, but can change to brown. Both males and females have a pink throat fan (a.k.a. dewlap), which is used as a means for inter- and intraspecific communication. Their toes are expanded at the tips to accommodate adhesive toe pads, which aid them in climbing smooth surfaces where claws cannot be used. The reproductive season takes place during the months of April through July, when the typically territorial males become even more intensely territorial, attempting to secure exclusive access to groups of females. Female anole lizards can lay one egg each week throughout the four-month breeding cycle. The green anole has been a particularly important organism for study in the scientific community, and has been successfully used as a model system for studying neurological disorders and for studying drug delivery systems and biochemical pathways relevant to human illnesses. They have also been essential for scientific progress in understanding other aspects of physiology and behavior in animals. The Genus *Anolis*, which includes over 350 recognized species, also serves as a group of major interest for exploring the evolutionary diversification, of particular interest is the repeated convergent pattern of adaptive radiation on islands of the Greater Antilles, producing on each island essentially the same set of habitat specialists adapted to use different parts of the environment. As a result, in 2005, the scientific community overwhelmingly chose the green anole lizard as its first target species for reptilian genome sequencing. In recent years, populations of *A. carolinensis* have apparently become less common, although no data are available. This decline is correlated with massive habitat alteration and the introduction of the brown anole (*Anolis sagrei*) from Cuba. *Anolis carolinensis* is derived from *A. porcatum* on Cuba, which coexists with *A. sagrei*. One possibility is that the presence of *A. sagrei* in Florida has caused *A. carolinensis* to return to the more arboreal ecological niche occupied by *A. porcatum*.

Terms of Use | Comments and Corrections | Privacy Policy | Help

Figure 1: Typical page from the EOL showing information on the Green Anole Lizard

1.2 Informatics

- To succeed, the EOL requires novel informatics tools to capture, organize, and present knowledge about biodiversity. The EOL's IT infrastructure must be able to seamlessly aggregate data from thousands of existing and future digital sources into individual species pages. To achieve this functionality, the Informatics Group will engage the broader biodiversity informatics community, collaborate with data providers, develop and employ software tools that exploit the full capacities of Web 2.0, and place these tools in an open environment where they can be continually improved.
- Aggregation (mash-up) technology can assemble different data elements from remote sites and make these data available via a single Web portal. The aggregated data, organized by both taxonomy and subject matter, will be manipulated through a range of tools and services to index, organize and associate data elements or create new elements. The portal will also include new visualization and analytical tools. It will provide services to both experts and enthusiasts, upon whom the EOL depends, and will allow users to reshape data for their own needs and for EOL Web pages. The software will be modular and placed in an open content management environment to guarantee that the EOL software continues to evolve. An attribution system will acknowledge credit and show data providers how their data was used. Information from the EOL will be delivered through a portal which will be sufficiently flexible for users to tailor 'MyEOL' to suit their individual needs and abilities.
- Working with partners such as the Catalogue of Life (www.catalogueoflife.org), the EOL will develop a global indexing system of scientific and common names for all organisms. This list will be integrated within a Global Names Architecture, a shared virtual repository that links all major compilers of names to ensure that the EOL index is current, comprehensive, and authoritative.

1.3 Scanning and Digitization

Scanning will be performed by a consortium of natural history libraries called the Biodiversity Heritage Library (BHL) (www.biodiversitylibrary.org). The goal is to make available online the published literature on biodiversity. Since most of this legacy literature presently exists only in print form, these works will be digitised and made available to anyone for free via the Internet.

The BHL will digitally link the enormous biological diversity of tropical and developing countries to the corresponding scientific literature about biodiversity that is held primarily in a few North American and European libraries. This intellectual "repatriation" will enable anyone who is not affiliated with major research and educational institutions to readily search, read, and even download articles previously unavailable to them. Educators will be able to guide students' research projects with access to a wealth of examples incorporated in lesson plans and assignments. Scientists will have immediate access to articles in the professional literature that are critical to their work. Artists will for the first time have routine access to inspiring illustrations in rare taxonomic works. Moreover, "taxonomic intelligence" software tools developed by the Informatics Group will be used to index these works according to the scientific name(s) of species discussed within them, thus helping users to find what they need.

1.4 Education and Outreach

By putting a vast amount of information regarding all living species within easy reach of anyone with a computer, the EOL has enormous potential to enhance the teaching, understanding, and appreciation of biodiversity among the general public and to engender a greater sense of stewardship of life on Earth. The Education and Outreach Group seeks to realize this potential by exploring and promoting the use of EOL in educational settings. The EOL has undertaken an initial user-needs analysis to identify typical "use cases". Initially, the EOL will target three audiences:

- Formal education (years 10-18 and university undergraduates) where the EOL will offer new access to data and novel ways to answer questions about the distribution of species over space and time.
- Informal education settings, such as natural history museums and nature centres, the EOL will extend learning outside the classroom.
- Citizen scientists will contribute to the EOL by entering species information from such activities as community- or school-based "bioblitzes" and individual observations. In turn, by extracting relevant species pages to create personalized field guides, they can enhance their knowledge of particular species and biodiversity within their communities.

1.5 Biosynthesis

The vast amount of data about living organisms that will be made routinely available by the EOL will enable scientists to study biodiversity and the evolution of life in new ways. This data will facilitate work in applied fields, such as conservation biology, land-use planning, and environmental management. The Biosynthesis Group will promote such activities by assembling and assisting specialist working groups, convening conferences and workshops, and help to develop relevant Web-based tools for integrating and analyzing species data. Its initial activities will address the following four themes:

- Biodiversity in space and time
- The Tree of Life (www.tolweb.org/tree/)
- Discovering and describing biodiversity
- Conservation of biodiversity.

1.6 Secretariat

The role of the Secretariat is to coordinate and facilitate the entire EOL development process, in consultation with the EOL's Steering Committee, Institutional Council, and Distinguished Advisory Board. The Secretariat project manages the EOL's main working groups.

2. CONCLUSION

Demand for reliable and understandable biodiversity information by the scientific community, natural resource managers, the education sector and the public at large is growing. The time is right for a digital Encyclopedia of Life because major advances in the Web have made information much more accessible and these new technologies provide the means to link this information in efficient and cost-effective ways. Over the next five years, the EOL will:

- Assemble a million species sites, each verified by an expert.
- Digitize a large portion of the existing biodiversity literature - BHL is targeting 100 million pages from all available sources.
- Release online educational materials for students, schools and universities, and actively engage with citizen science groups.
- Use the EOL resource to generate new synthetic knowledge about the world's biological diversity.

By empowering individuals around the globe with unparalleled access to knowledge and information, and by fostering international communication and collaboration, the EOL has the potential to transform the way people think about, study, and appreciate biology and the world around us.

4. REFERENCES

Wilson, E.O., 2003. The encyclopaedia of life. *Trends Ecol Evol*, 18,pp.77–80

3. ACKNOWLEDGMENTS

James Hanken, Chair of the EOL Steering Committee and Director of the Museum of Comparative Zoology, Harvard – together with all the staff of the EOL - for helping to develop this paper. The John D. and Catherine T. MacArthur Foundation and the Alfred P. Sloan Foundation for committing the critical financial support needed to establish the Encyclopedia of Life.

EUROPEANALOCAL: ITS ROLE IN IMPROVING ACCESS TO EUROPE'S CULTURAL HERITAGE THROUGH THE EUROPEAN DIGITAL LIBRARY

Rob Davies

MDR Partners, 2b Fitzgerald Road, London, United Kingdom
rob.davies@mdrpartners.com

KEYWORDS: Very large digital libraries, European Digital Library; Europeana; EuropeanaLocal; digital libraries; local and regional libraries; digital cultural heritage; best practice network

ABSTRACT:

This paper explains the role and approach of the EuropeanaLocal project in helping to build the European Digital Library. It describes some of the issues and challenges, related to the development of very large digital libraries, that the project will tackle. By September the author will also be able to supply a report on progress to date.

1. CONTEXT AND RATIONALE

“Culture may even be described simply as that which makes life worth living”.

Eliot, T. S. (From: The Oxford Dictionary of Modern Quotations).

EuropeanaLocal is one of a suite of projects, funded by the European Commission, designed to build a very large digital library indeed – the European Digital Library, or Europeana as it is now known. Horst Forster, the European Commission's Director of Digital Content and Cognitive Systems, describes the Commission's vision as follows: ‘In the context of our i2010 - Digital Libraries initiative the European Commission envisages the creation of a European Digital Library: a unique resource to Europe's distributed cultural heritage, ensuring a common access to millions of great paintings, historical writings, ancient manuscripts, diaries of the famous and not so famous, personal photos, and important national documents from Europe's libraries, archives and museums.’

Europeana, the European digital library, museum and archive, is a 2-year project to begin to make the vision a reality, which began in July 2007. The first version of the public prototype website is due to be launched in November 2008, and will initially give users direct access to some 2 million digital objects, selected from that which is already digitised and available in Europe's museums, libraries, archives and audio-visual collections.

The European Digital Libraries Initiative is set in a context of increasing global interest in large scale international, multilingual digital libraries initiatives, the most prominent of which are:

The *World Digital Library*, which will make available on the Internet, free of charge and in multilingual format, significant primary materials from cultures around the world, including manuscripts, maps, rare books, musical scores, recordings, films, prints, photographs, architectural drawings, and other significant cultural materials. The objectives of the World Digital Library are to promote international and inter-cultural understanding and awareness, provide resources to educators, expand non-English and non-Western content on the Internet, and to contribute to scholarly research.

Librarian of Congress James H. Billington proposed the establishment of a World Digital Library (WDL) in a speech to the U.S. National Commission for UNESCO in June 2005. The Library of Congress is currently engaged in a planning process to determine how this vision can be realized, which includes libraries and cultural institutions from around the world that have expressed interest in joining the project from countries such as Brazil, Egypt, Iraq, Qatar, Russia, Saudi Arabia Serbia, Sweden, Taiwan as well as the USA. In addition to UNESCO and IFLA.

Similarly, the main objective of *Biblioteca Universalis* is to make the major works of the world's scientific and cultural heritage accessible to a vast public via multimedia technologies. The aim is to exploit existing digitization programs in order to build up a large distributed virtual collection of knowledge and make it available to end-users via global communication networks, thus establishing a global electronic library system. *Biblioteca Universalis* is a G-7 project and the founding partners were the national libraries of France, Italy, Germany, the U.K., Japan, Canada, and the U.S.A with others joining since.

2. EUROPEANALOCAL: DESCRIPTION AND PURPOSE

A ‘cluster’ of projects, of which EuropeanaLocal is one, have been funded by the EC, mainly under the eContentPlus Programme, to help further develop Europeana. Others include: Athena, the European Film Archive, and the European Archival Portal project. EuropeanaLocal is unique in that it has a special focus on institutions at the local and regional level.

The evidence of existing and latent demand for content to be accessible online is by now well established. There are numerous case studies demonstrating that access to the many types of digital content made available on the web by local cultural institutions is exponentially greater than that only made available through physical collections. This impact is significantly increased when content is made available and optimised for discovery through Google. When online discovery and use to meet the needs of specific ‘market’ sectors are made accessible through popular added value service providers, use and subsequent demand for similar content is likely to increase further.

Evidence suggests that demand for cultural content for the purposes such as tourism, migration, employment personal or academic research, education, business and general interest are no less susceptible to these patterns than any other. Research into the still somewhat fragmented field of family history, with its close links to the culture of place and history is purportedly the fifth largest category of user interest on the World Wide Web.

Europe as a geographic and political region provides a coherent user view onto cultural content and Europeana is a logical way to provide such a view. However, a very great deal of user interest has as its context the notion of place or locality. And where the interest is in, for example, the life of a person, that life is very often closely linked to places. A high proportion of the content available about places, digital or otherwise, is created by or resides in the specific place. Where treasures, content and information about a place are collected and made available by national institutions, very often access to local or regionally held content is required to complete the picture. Meeting and stimulating user demand in this kind of way is perhaps the chief justification for EuropeanaLocal.

EuropeanaLocal is a Best Practice Network, funded under the eContentplus programme, which started on 1st June 2008. EuropeanaLocal partners have already identified and listed some 20 million items of content which they plan to make available over the course of the next three years. At the moment it is all public domain, but Europeana will handle in-copyright material in due course. Material identified is held by local museums, libraries and archives and covers a range of formats including images, film, sound and text. The subjects covered span a very broad range of topics including: tourism, education, family history, humanities, publishing/media industries, archival material and records of various types.

The consortium involves a significant number of best practice exemplars (e.g. the partners from France, Italy, Norway, Poland, Spain, Sweden, UK) in terms of digitisation, content aggregation (portals/digital libraries public access harvesting infrastructures based on OAI-PMH., but also partners with less or no experience in these areas. A breakdown of partners shows that, in addition to the EDL Foundation there are 1 Ministry of Culture, 3 national libraries (as aggregators of local content), 2 national museums, 3 national cultural agencies, 5 regional cultural authorities, 7 public libraries, 1 local, museum, 1 research foundation, 1 regional digital library provider and 6 companies. EuropeanaLocal will enable exchange of knowledge and experience which will quicken the pace of digitisation and co-ordinated access provision and also provide valuable feedback for the longer term development of Europeana.

EuropeanaLocal's approach will involve the establishment of a harvestable network of OAI-PMH compliant metadata repositories, aggregating content at a level which makes sense in terms of the diverse demographics and digital content holdings of Europe's municipalities, regions and localities and which complements the existing and planned Europeana network. EuropeanaLocal's job is to enable aggregators and single providers of digitized cultural heritage content to make it available for harvesting, indexing, enriching and other operations by Europeana (and indeed any other service). The content providers include local and regional cultural heritage institutions such as libraries, museums, archives, audio-visual archives.

OAI-PMH repositories, Europeana metadata application profiles and SKOS are probably the most prominent standards/tools envisaged at this stage but EuropeanaLocal partners are committed to try to conform with/adapt/utilize whatever technologies and standards the Europeana service adopts or creates as it develops. EuropeanaLocal will ensure that the approaches, standards and tools developed by Europeana are adopted widely across the cultural heritage sector, thereby supporting the interoperability of content within Europeana beyond that which is held by purely national level institutions.

3. EUROPEANA – BASIC PRINCIPLES

A number of fundamental assumptions have emerged at the strategic and political levels for Europeana and may be seen as conditions which are highly relevant to the positioning and goals of EuropeanaLocal.

- Europeana will be a federated digital library built on distributed, autonomous and heterogeneous resources: this fact creates specific conditions and challenges for technical, functional and semantic interoperability.
- Europeana will be an access point to cultural content and not just a discovery point.
- Archives and museums must be involved effectively and visibly in Europeana, as soon as possible.
- Europeana will provide access to text, pictures, video, sound and 3D objects.
- For 2008, the focus is upon open access, digital, freely available and public domain material — in order to minimise copyright issues in the early stages of development. However, all freely available content and metadata should be covered by a suitable licence clearly specifying the respective rights and use conditions.

A number of recommendations have begun to emerge through the initial work of Europeana, providing early guidance on its functional scope and the minimum interoperability criteria by 2008. Those being addressed include:

- user requirements;
- object models (granularity and structure);
- persistent identifiers;
- metadata/packaging standards
- service description framework for service registry;
- licensing policies;
- authentication data exchange;
- basic semantic interoperability;
- interoperation of Europeana and other services on the web (such as Google).

In addition, a number of areas have been identified as elements needing clarification in the longer term, probably beyond the delivery of Europeana prototype service in the Autumn 2008 but many of which will become relevant to implementation within the proposed duration of EuropeanaLocal (2008-11). These include:

- authorization (role models and role semantics);
- usage logging;
- accounting, payment;
- legal and access protection issues (IPR / rights / DRM);
- advanced semantic interoperability (concepts / ontologies / rules / reasoning), including mapping to object modelling standards;

- name authority services;
- multilingualism of content;
- service description as a basis for service integration;
- technical and economical sustainability;
- preservation aspects.

4. MULTILINGUAL ASPECTS

To look at one of these in more detail: multilingual or multicultural aspects will obviously loom large in very large digital library which provides access to digital content held by cultural institutions from all the countries of Europe. European citizens will wish to use their respective own languages for interaction with Europeana functions and it will not be possible to require the use of English language from them (nor would this comply with EU policy). However, the achievement of even a basic service in the prototype intended for 2008, working across 20+languages is a challenge which has been scoped very carefully.

The first version of the Europeana functional specification identified four levels of potential implementation regarding language interoperability: interface, browsing, search and results translation. The first version of the prototype will probably be limited to the simplest of these - an interface localised in the major European languages. The European Library (TEL) currently has interface translations available in 21 languages, which should provide a good starting point for Europeana. Enable browsing via a common multilingual ontology mapped onto versions for each language should also be relatively simple to execute. For the first prototype it is envisaged that this could be implemented at a fairly high level with a multilingual backbone created by SKOSification and alignment of multilingual thesauri and ontologies. This would provide the user with native language support at the interface, browse and result level. Established multilingual initiatives, like MACS, CRISSCROSS, MSAC, Michael+ and VIAF are seen as potentially useful building blocks on which Europeana could build with regard to the development of multi-lingual browsing. If all goes well Europeana intends to provide three levels of access: 1. efficient monolingual search in all languages supported by Europeana; 2. simple crosslanguage access (querying in one language against a target collection in a second language and 3. multilingual access (querying on Language 1 against target collections in Ln, where n=all languages supported by Europeana) and a preliminary version of (2.) is planned for the first public prototype. Results translation, even in a medium term, is likely to be restricted to metadata and abstractions as these are likely to be the only targets within reach of the service given the Europeana working model.

EuropeanaLocal will support the creation of a diverse and inclusive digital library, facilitating access to culture by all communities and individuals, and representative of diverse cultures and languages through the supply of a large amount multilingual and multicultural content from every member state and many diverse regions on which proposed Europeana applications and services can be developed and tested; by supporting the development of semantic approaches to multilingualism in the longer term by supplying and converting through SKOS locally-used multilingual vocabularies from domain and cross-domain based services. This will support identification of the extent to which translation tools (metadata, object data) and available vocabularies can support multilingual access to Europeana; by promoting and disseminating news and guidance of Europeana policies, guidelines and services among

holders of local and regional content, decision makers and other stakeholders at that level.

5. EUROPEANALOCAL – PROJECT APPROACH AND STRUCTURE

The EuropeanaLocal project aims to achieve its goals through a number of phased activities as follows: The work will begin with a relatively brief phase of necessary survey work to determine the range of available content and metadata schema and approaches, metadata harvesting activities and repository aggregation levels, in use by Europe's museums, archives, libraries and other cultural content holders at local and regional level. This will be related to the findings and recommended architecture of Europeana in order to arrive at a workable approach to metadata interoperability. The next stage will take the form of a process of content analysis in each region in order to assist in the identification of cross-border and Pan-European 'themes' of importance to potential users and to assist with the prioritisation of the addition of new content to the Europeana service.

Content harvesting and aggregation will involve the establishment of a central, scalable test execution environment, consistent with and linked to that of Europeana, into which any new local content aggregator can easily plug and in which modifications potentially beneficial to Europeana interface can be tried out and implemented. This work will enable the conditions for planned and phased harvesting of content into that environment to be tested and understood, and will establish a central service that will manage the necessary synchronization in a network of OAI-PMH servers and provide a central metadata repository service and index.

Another strand of the project will focus on the planned and phased adoption of tools and standards as they are developed and released by Europeana and according to their timescales. EuropeanaLocal will provide an opportunity to adapt tools to content providers' needs in a concerted manner Europe-wide and, perhaps especially, to deal with the problems of configuring OAI-repositories to serve up data that is not in one of the major domain-recognised formats in its native form. EuropeanaLocal will test the tools recommended by Europeana against the real-world environment of its content providers, customising the tools as required, providing relevant documentation and installation support and reviewing the output. Where there are lacunae in the availability of tools for performing key implementation tasks, EuropeanaLocal will, through activity led by its technical partners seek to identify suitable tools from the wider technical environment.

The project will also provide for the establishment and delivery of a training process and a project-long technical support service for EuropeanaLocal partners and content providers. This will cover best practice in installation, implementation the use of tools associated with OAI-PMH implementation, repositories, database conversion, metadata mapping, collection level description, vocabulary conversion through SKOS, rights expression and semantic enrichment. A series of multi-regional workshops will be organised and a help desk will be established to achieve this, supported by the publication of best practice guidance.

An important part of the project will be dissemination and awareness raising which will promote the results and availability of the EuropeanaLocal service. It will also address

future governance and roll out of regional and local participation consistent with that of the Europeana. EuropeanaLocal will agree straightforward administrative and technical procedures whereby providers of content/metadata may become contributing members of Europeana and a basis on which e.g. any subscription charges, other costs or conditions of joining may be determined. This is likely to involve, in many cases, the establishment of processes and agreements in each country, whereby such arrangements are conducted on behalf of local content providers by aggregators, thus reducing the number of organisations with which EDL Foundation has to conclude agreements to more manageable numbers. In line with the governance procedures established for Europeana, it will also be important to agree the conditions and procedures for establishing participation of representatives of the local/regional content provider community in the future governance of Europeana.

End users will be involved in the validation of the work of EuropeanaLocal through the establishment of a user testing group, consisting of a demographically segmented group (by age, level of education, social grouping) of some 20-40 users in each partner region. These user groups will be called upon to carry out structured usability testing of Europeana prototype interfaces at various key stages of the project.

6. CONCLUSION

EuropeanaLocal is an ambitious project which aims to assist the European Digital Library reach critical mass in terms of audience, contributors and content by providing a convincing demonstration at European level of the feasibility of cross-domain co-operation in the area of digital content provision, even though patterns in individual countries may vary.

The Europeana website contains the most current information <http://www.europeana.eu/> and an EuropeanaLocal website was launched in July 2008. <http://www.europeanalocal.eu/>

7. REFERENCES

Biblioteca Universalis

<http://search.theeuropeanlibrary.org/portal/en/index.html>

Commission of the European Communities. Com(2005) 465 final. Communication from the Commission to the European Parliament, the Council, the European Economic and Social Committee and the Committee of the Regions: I2010: digital libraries. http://ec.europa.eu/information_society/activities/digital_libraries/doc/communication/en_comm_digital_libraries.pdf

Creating Cross-Domain Consensus for the European Digital Library. <http://www.blueconsultants.com/edlnet/>

Europe's Information Society Thematic Portal. What is the Digital Libraries Initiative? http://ec.europa.eu/information_society/activities/digital_libraries/what_is_dli/index_en.htm

Europeana: connecting cultural heritage
<http://www.europeana.eu/>

World Digital Library
<http://www.worlddigitallibrary.org/project/english/index.html>

Digital Reconstruction and 3D Modeling

THE DIGITAL ARCHAEOLOGICAL RECONSTRUCTION OF THE A FAMOSA FORTRESS, MALAYSIA

M.I ZainalAbidin^{a,*}, A. Bridges^a, & A. Razak^b

^aDepartment of Architecture, University of Strathclyde, 131 Rottenrow G4 0NG UK –
(mohamad.zainal-abidin , a.h.bridges)@strath.ac.uk,

^b Faculty of IT, Multimedia University, Cyberjaya, 63100 Malaysia - aishah@mmu.edu.my

KEY WORDS: Digital archaeological reconstruction, fortress, cultural heritage, 3D model, virtual world

ABSTRACT:

The “A Famosa Fortress” is one of the oldest partially extant European buildings in Malaysia. Its origins may be traced back to a fortress built by the Portuguese in 1511. The fortress is located in the city of Melaka and was largely destroyed during the British occupation of 1824. Throughout that 300 years period of occupation it went through several architectural developments and changes. At the moment there is no major action taken to fully preserve this heritage. Additionally, with the complex logistic condition and geographical factor of the Melaka city today, it is impossible to fully reconstruct this fortress in its physical context. As an alternative solution, we propose to digitally reconstruct the development of this fortress in various eras. There are several challenges to be overcome in developing the digital archaeological reconstruction of the A Famosa Fortress such as the long timescale of development and rebuilding on the site; the minimal amount of authoritative documentation and the variety of measurement systems and graphical projections used in the early descriptions of the fortress. This paper presents some findings on the architectural information of the fortress based on various data sources and some preliminary approaches that we have done to verify the consistency, similarity and integrity of the data. This verification of data is the most important process in this research considering the remaining of the fortress is no longer available. From the result, we found that the fortress undergo different development stages under different occupation and a lot of data still need to be collected to get an accurate measurement of the fortress. In the future work, we proposed to use the traditional 3D polygonal modelling for the digital reconstruction of the fortress.

1. INTRODUCTION

1.1 Background

Historically, Melaka’s strategic position in South East Asia has made it as an important centre of commerce (Thomaz & Pintado, 2000). The traders used to trade various items such as spices, cloth, tin, silk, porcelain and many more. These traders came from all over the world: India, China, Borneo, Arabia and Europe. Melaka’s popularity attracted the Portuguese to expand their power in commercial dealings, military occupation and religion. The Portuguese believed that by controlling Melaka, they could monopolise spice trading which was a very valuable item in Europe and expand their military power. One said that whoever is lord of Melaka has his hand on the throat of Venice (Pires & Rodrigues, 1944). Besides, one of the Portuguese’s objectives was to expand the influence of Christianity in this region and this could only be done by seizing Melaka.

In 1511, the Portuguese, with fifteen small and great sails and with sixteen hundred fighting men laid siege to Melaka (Ryan, N. J. 1960). With advanced strategy and weapons, the Portuguese managed to capture Melaka within three weeks and, on August 10th, 1511 Melaka fell into Portuguese hands (Noonan, L. A. 1989). Albuquerque was the captain for the new Portuguese government in Melaka. He immediately ordered a fortress to be built for defensive purpose (Eredia & Mills, 1997). With this success, it also attracted the Dutch with the monopoly of the trading in South East Asia. The fortress of Melaka continued its architectural development over this time. Prior to the occupation of the Dutch, they heavily bombarded the fortress which has critically destroyed part of the fortress.

After they succeeded to conquer Melaka in 1641, the Dutch carried out major reconstruction on the fortress as part of their strategy to strengthen their power. This reconstruction involved the extension of the fortress walls and bastions (Leupe & Hacobian, 1936).

When the British took over the Dutch’s position in 1824, the British captain in Melaka, William Farquhar instructed the fortress to be destroyed. As the result, the only evidence left today is a gate to access the fortress which is known as Porta de Santiago (Figure 1). The entire occupation timeline is summarised in Table 1.



Figure 1: Remains of old Portuguese fortress in Melaka, Porta de Santiago (Asia Explorers, 2003)

* Corresponding author.

Conqueror	Occupation
Portuguese	1511-1641
Dutch	1641-1824
British	1824-1957

Table 1: A timeline of occupation in Malaysia

1.2 Motivation

Presently the Malaysian government is taking another step to preserve some of the new findings in this fortress. The conservation team is reconstructing one of the bastions known as the Middleburgh bastion which dates from the Dutch occupation. Nadharaj (2003) explains, "However, work to uncover more of the buried wall, despite its historical significance and potential to draw more tourists into the area, may not be feasible as it would involve tearing up the major road that links the old town with the new commercial area". Hence, only certain part of the fortress can be reconstructed. In order to solve this problem, we propose to digitally reconstruct this fortress in form of 3D model which can be navigated in the virtual world. Since the fortress itself has faced several changes in its design and layout, by reconstructing it in 3D allows the researchers to investigate and study the development of these changes from architectural and historical aspects.

1.3 Objectives

There are several objectives for this research:

1. To collect and analyse all the related documents about this fortress and translate into visual forms.
2. To study the historical and architectural background of the fortress including the functions and structures from various resources.
3. To reconstruct the fortress design development in 3D models based on collected data from various resources.
4. To provide reliable and standard 3D models of this fortress for architectural visualization and historical education purpose.

2. ISSUES

There are several challenges encountered in developing the digital archaeological reconstruction of the A Famosa Fortress. They are as explained below:

1. The use of advanced methods such as photogrammetry and 3D laser scanning to develop the digital model are not possible because the fortress has been badly destroyed. Physical reconstruction of the fortress requires a very long timescale of development and rebuilding the entire fortress on the site is nearly impossible because the fortress's location now has been developed into a busy city.
2. It is inarguable that the lack of authoritative documentation is the main obstacle in this research. Most of the documents are scattered all over the world. To trace these documents requires us to contact related bodies in the countries that were involved in the past occupation in Melaka such as Portugal, Netherlands and Britain. Additionally these documents are very old and require translation.
3. The variety of measurement systems and graphical projections used in the early descriptions of the fortress requires us to translate them into standard units. Other than that we also need to compare its old graphical projections

and match with other graphical and textual resources. Any similarity in these findings will strongly support our rationale.

3. FINDINGS

3.1 Fortress design development

At this stage, we managed to collect several drawings and paintings from various resources (mostly during Portuguese and Dutch era) that describe A Famosa in visual form. These drawings have some similarities between each other. Other than visuals we also found some textual descriptions about this fortress which are very helpful to assist and support the reconstruction process. These textual descriptions are taken from old letters and books. For instance, Lima, (1988) states that in 1588, Joao Baptista Cairato, an Italian military architect had inspected the fortress and made suggestion on alteration for military security purpose.

Based on our analysis on the collected data, we have categorised the design development of this fortress into 4 stages namely;

1. The early stage: single building with a tower
2. Extension of fortress under the Portuguese occupation
3. The Dutch occupation
4. The British occupation

3.1.1 The early stage: single building with a tower: In the early Portuguese Malacca book, Thomaz et al., 2000, describes figure 2, "Malacca in the first half of the 16th century according to a plate from 'Lendas da India' by Gaspar Correia. The walls had not yet been raised and the central district, as weak as the district of Upeh is protected by a simple palisade. The Famosa fortress stands out, clearly medieval, with its four storey keep and a single bastion facing the sea, to place artillery. All the houses are apparently covered by a vegetal substance.



Figure 2: Fortaleza de Malacca, drawing by Gaspar Correia, 1527, in his manuscript works, "Lendas da India" (Correa & Felner, 1975)

There are no convents yet, only the mother church, next to the fortress, and a small chapel on the hill. The sketch is obviously, rather schematic and does not convey the dimension of the city, which should, according to both the calculation of the Sejarah Melayu and Portuguese, number about 200 000 souls.

Figure 3 presented a more detailed plan of 'A Famosa' built by Alfonso de Albuquerque in 1511. The tower called 'Fortaleza' which served as residence of the captain, the courtyard with a well, the jail (tronco) and the magazine (almazem) where guns, ammunition and navigation implements were kept.

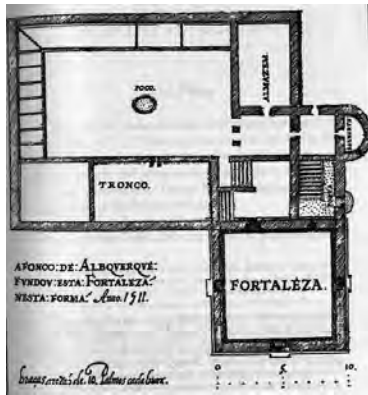

Figure 3: Plan of the 'A Famosa' source Thomaz et al (2000)

3.1.2 Extension of fortress wall under the Portuguese occupation (within 1568-1604): The actual date for the drawing in Figure 4 is unknown but it was published by Silveira, (Silveira, 1956) and Manguin (Manguin, 1988). Manguin came out with a proper drawing that describes the details in the fortress. The drawing noticeably shows the wall extension of former fortress in figure 2 (marked with black circle). Manguin has clearly indicated some of the most important fortress elements in his reproduced drawing such as the number and names of the bastions, hospital, churches, fortress gates and tower bridge.

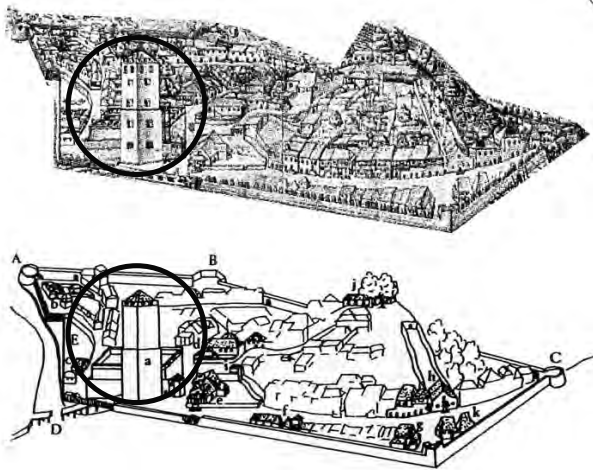

Figure 4: Anonymous Portuguese drawing of the Malacca fortress, dated 1568. The original is kept at the Biblioteca Nacional, Rio de Janeiro, Brazil (Correa & Felner, 1975).

The extension of A Famosa is also supported by Thomaz et. al, 2000 which explained Figure 5 as "The walled section of Malacca in 1604 according to a sketch by Manuel Godinho de Eredia. The wall is already completed, encompassing the former fortress, with its tower, all public buildings (town hall, bishop's place, Santa Casa da Misericordia, two hospitals, the school of the Jesuits and several churches and convents). The wall features seven strongholds destined for artillery, both on land and sea sides (Figure 5). The sketch notes the contours of a new outline, broader, on the land side, that was to remain only a project. The walled section encompasses a green area on the hillside, where the school of the Jesuits stood, accessible through three staircases".

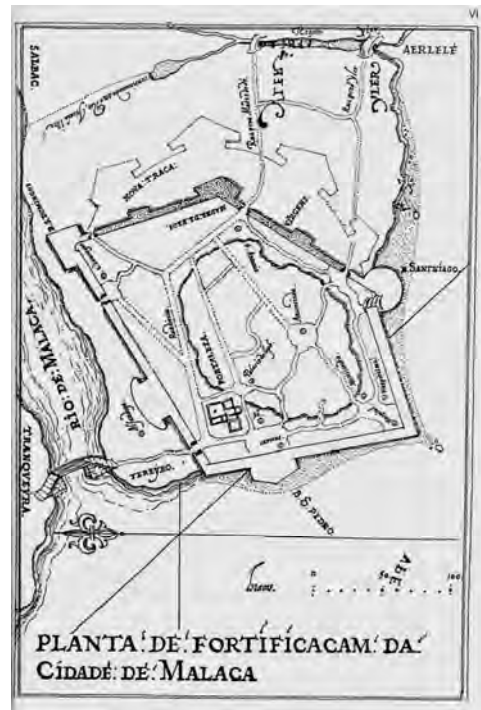

Figure 5: Eredia's drawings (1604) of the fortress of Melaka



Figure 6: Sousa's drawing on Melaka, 1660's

Figure 6 shows another illustration of the extended wall of A Famosa during Portuguese occupation. It is entitled "Plan of Malacca" by Manuel de Faria e Sousa, Portuguese chronicler, from a work entitled "Asia Portuguesa", published in Madrid in the 1660's (Kennedy, 1962).

3.1.3 The Dutch occupation: Figure 7 illustrated A Famosa during the Dutch era by Heydt which was a very detailed drawing complete with scale and legends. This was between 1735 – 1744. The drawing clearly shows some of the additional elements such as walls and bastions. The fortress itself has a few changes particularly outside the walls which are surrounded by the moat. It is also found that the size of the fortress has been extended during the Dutch era as compared to during the Portuguese era.

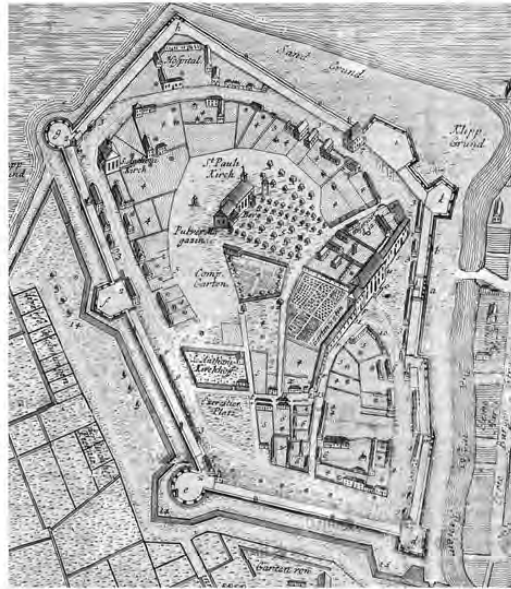

Figure 7: The Dutch drawing, Copperplate printing of Plan oder Grund Riss der Stadt u. Vest. Malacca by Helydt, Johan Wolfgang

Most of the drawing during the Dutch era is more accurate, well organised and properly described. It also includes the measurements and elements of the fortress.

3.1.4 The British Occupation: According to the history, after Malacca fell into British's hand, it had long since ceased to be of any commercial importance, and in order to avoid the expense of maintaining the fort and to prevent it from becoming danger if it fell again into other hands, the walls of fort were destroyed in 1807, by William Farquhar, the British captain. As the result, the only evidence left today is a gate to access the fortress which is known as Porta de Santiago (Figure 1).

3.2 Comparison of drawings

As we can see from the collected drawings, it is difficult to make a direct comparison from one source to another since the drawing is based on different perspective and era. This is because the development of this fortress itself can be divided into four stages as discussed previously and most of the drawings during Portuguese era were not properly labelled and did not include any measurement.

As one of our preliminary solution to solve the above problem, we tried to map each of the different illustrations into one common perspective. For an initial comparison, we have chosen the Dutch drawing as our main plan and project it onto several Portuguese perspective drawings as shown in Figure 4. The observations have highlighted some differences in size and shape of the fortress between the two eras. Further study is needed to identify more detail information.



(a)



(b)



(c)



Figure 8: Projection of the Dutch era of Malacca fort onto Portuguese drawings: a) the outline of Figure 4, b) Projection of (a) to Figure 4, c) Projection of (a) to Figure 5 and d) Projection of (a) to Figure 7.

3.3 Fortress elements

The major fortress elements are walls and bastions. Each bastion has its name, based on our findings the name for each bastion also being changed when the Dutch captured Melaka from the Portuguese. According to the Malacca Centenary Committee the names of the bastions are as below:

Dutch names	Portuguese names
Fredrick Hendrick	Courassa
Middleburgh	
Ernestus Casimir	Hospital de Povne
Amsterdam	St. Domingo
Victoria	St. Domingo
Emelia	Madre Deos
Henriette Louijse	Ongie Mille virgines
Wilhelmus	St. Lago
Mauritius	Hospital del Rey

Table 2: Bastions in the old fort (Malacca Centenary Committee)

3.4 Fortress measurement

As discussed earlier, it is difficult to get accurate measurements for the fortress especially during the Portuguese era since it is not drawn up to scale and hardly include any measurement or label. Further more, according to Eredia (1997), A Famosa had the shape of a pentagon and its perimeter was 655 fathoms which is equal to 1.441 km. However, the correct metric conversion of 1 fathom is equal to 1.8288, this means 655 fathoms is equal to 1.198 km. This is another example of problems in assembling accurate data for reconstruction.

Based on our research on various sources, we have come out with a rough measurement of the fortress wall during the Dutch era as presented in Figure 9. We have also done some calculations to prove that the wall measurements and the angle connecting the wall, is consistent and correct using the law of sine and the law of cosines.

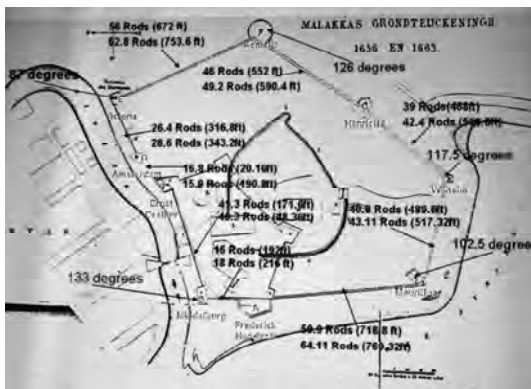

Figure 9: Measurement of the fortress wall during Dutch era.

4. FUTURE WORK

Presently we are still collecting as much information as possible about this fortress. Since the remains of the fortress are very small, the only method of reconstruction is traditional 3D polygonal modelling. The use of advanced methods such as photogrammetry and 3D laser scanning are not practical due to these methods requiring physical objects to be measured. We propose that the process of the 3D modelling will commence once the data is fully obtained and the major arguments are answered. Theoretically all of the information from the drawings and textual descriptions will be translated into visual form. This will assist the researchers if any confusion in 3D modelling process happens. The 3D models will be modelled in

3DS Max and the process of retracing the plans will be done in Auto CAD.

5. CONCLUSIONS

In our attempt to reconstruct this fortress into digital format we found that it is not possible to come out with one fixed and permanent design. This is because the studies have proven that 'A Famosa' has gone through different modifications and physical reconstruction. Historically this fortress has changed hand from the Portuguese to the Dutch and finally to the British. Hence, the 3D models that we proposed are to be based on the identified development of this fortress design. Presently we have not decided about the actual 3D models to be developed until we finalised our data collection.

Another important challenge is that the early evidence such as perspective drawings and plans are not to scale, have incorrect perspective points and no proper measurements. In order to reconstruct these 3D models, we need to analyse the collected data supported by the textual descriptions from old letters, journals and books. These facts must match and support each other.

6. REFERENCES

- Asia Explorers., 2003. Article on Exploring the Porta de Santiago (A Famosa) Remains of old Portuguese fort, Malacca, Malaysia. http://www.asiaexplorers.com/malaysia/porta_de_santiago.htm (accessed 02 Jun. 2008)
- Bocarro, A. (1991). O livro das plantas de todas as fortalezas, cidades e povoações do estado da Índia Oriental. Lisboa: Imprensa Nacional.
- Correã, G., & Felner, R. J. d. L. (1975). Lendas da Índia. Tesouros da literatura e da história. Porto: Lello & Irmão.
- Elias, P., 1780, Map of the city and fort at Malacca <http://www.nationaalarchief.nl/amh/detail.aspx?page=dafb&lang=en&id=2165#tab0> (accessed 1 Jun. 2007)
- Godinho de Eredia, M., & Mills, J. V. (1997). *Eredia's description of Malaca, Meridional India, and Cathay*. Kuala Lumpur, Malaysia: Malaysian Branch of the Royal Asiatic Society.
- Heydt, Johann Wolfgang, 1735 - 1744, Map of Malakka, <http://www.nationaalarchief.nl/amh/detail.aspx?page=dafb&lang=en&id=5560> (accessed 17 Jul. 2007)
- Iria, A. 1960-6 I. 'Elementos de estudo acerca da possível contribuição portuguesa para a organização do Museu Histórico de Malaca', *Studia*, V-VII: 47-120, VIII:07-333.
- Kennedy, J. (1962). *A history of Malaya, A.D. 1400-1959*. [New York], St. Martin's Press
- Malacca Centenary Committee. (1936). *Historical guide of Malacca*. [Malacca]: Malacca Historical Society.
- Leupe, P. A., & Hacobian, M. (1936). *The siege and capture of Malacca from the Portuguese in 1640-1641: extracts from the archives of the Dutch East Indies Company*. [Singapore, Malayan

Manguin Pierre-Yves, (1988). Of Fortresses and Galleys The 1568 Acehese Siege of Melaka, after a Contemporary Bird's-Eye View, *Modern Asian Studies*, Vol. 22, No. 3, Special Issue: *Asian Studies in Honour of Professor Charles Boxer*, pp. 607-628

Noonan, L. A. (1989). *John of Empoli and his relations with Afonso de Albuquerque*. Lisboa: Ministério da Educação, Instituto de Investigação Científica Tropical.

Pires, T., & Rodrigues, F. (1944). *The Suma oriental of Tomé Pires, an account of the East, from the Red Sea to Japan, written in Malacca and India in 1512-1515, and The book of Francisco Rodrigues, rutter of a voyage in the Red Sea, nautical rules, almanack and maps, written and drawn in the East before 1515*. London: The Hakluyt Society.

Ryan, N. J. (1960). *Malaya through four centuries an anthology, 1500-1900*. London, Oxf. Univ. Press, pp. 6

Silveira, L. 1956. *Ensaio de iconogaja das cidadesportuguesas do Ultramar*, Lisboa, 4 vols.

Thomaz, Luís Filipe F. R., and Manuel Pintado. 2000. *Early Portuguese Malacca*. [Macau]: CTMCDP/IPM, pp. 19.

Vanitha Nadharaj , Article on The Star Sunday July 27, 2003, "New interest in an old fort", Kuala Lumpur, Malaysia http://allmalaysia.info/news/story.asp?file=2003/7/27/state/5811969&sec=mi_malacca (accessed 6 Jun. 2007)

Viana de Lima, A. E. (1988). *Reviver Malaca = Malacca, a revival*. Porto, Viana de Lima e Livraria Figueirinhas.

VISUAL APPEARANCE OF A MIDDLE AGE SCULPTURE. POLYCHROMY AND LIGHTING SIMULATION

Sylvain Dumazet, Patrick Callet

Applied Mathematics and Systems Lab., Ecole Centrale Paris, grande voie des vignes, Ch[^]tenay-Malabry, France
sylvain.dumazet@ecp.fr, patrick.callet@ecp.fr

KEY WORDS: Colorimetry, spectral simulation, rendering, lighting, spectral calibration, paint, medieval palettes.

ABSTRACT:

The restitution of the visual appearance of the recumbent of Philippe Dagobert (1222-1235) situated in the royal necropolis of Saint-Denis, near Paris, is presented. The presented works gather the first results where pigments identification was made using non-contact optical methods (spectrophotometry) and some micro-analyses for a complete discrimination of the materials employed for polychromy. The lighting spectral simulations are made with Virtuelium, our spectral ray-tracing software including light transport with polarization and parallel computations and an extended photon-mapping algorithm for global illumination. A precise material characterization, an accurate lighting model based upon many optical measurements are not completely sufficient for obtaining realistic images of what was looking like the statue at the medieval epoch. A set of visual experiments has been proposed for validation. That last part of the work is presented with the use of a light box (visual examination booth) including 5 CIE illuminants (D65, CWF, A, TL84, UV) with a quasi diffuse environment (Munsell Grey N7). The spectral calculation method is exposed, discussed and illustrated.

1. INTRODUCTION, HISTORICAL CONTEXT

The polychromatic studies applied to a french medieval sculpture started in 2004. The first phase of the project dealt with the 3D shape reconstruction of the whole monument (recumbent and tomb of Philippe Dagobert) and the material study of paint remains. Having obtained interesting results for the virtual restoration of the painted sculpture using physical and optical properties, we now start to attempt and characterize the most probable lighting conditions in which the statue were commonly placed in the cistercian church of the Royaumont abbey. During the french Revolution, the church was destroyed and the royal tombs were moved to Saint-Denis basilica. For a correct virtual color restitution the object must not only be represented in its actual shape, that is of a very limited interest, but also with the original paints and lighting conditions. Such an "archaeology of light" involves the study of the lighting devices at the medieval era.



Figure 1: The récumment of Philipe Dagobert at its actual place in Saint Denis basilica.

Several hypotheses are made for having images of a set of more or less plausible restitutions. King Saint-Louis built the cistercian abbey but, paradoxically imposed polychromatic ornaments for the recumbent of his young brother died around 1234-1235. Some documents attest the possible existence of a polychrome stained glass window representing the young prince with the same clothes as the recumbent drawings from Gaignières show.

2. SHAPE RECONSTRUCTION

2.1 Shape and visual appearance

The shape is required for understanding the influence of the multiple light-reflections from one surface to another or itself. In the case of inter-reflexions we have spectral multiplications of the reflectance factors. Though this effect is very important for specular surfaces it also has a sufficient effect for diffuse surfaces. The visual appearance of gilded surfaces mainly depends on the shape complexity on which the gold leaves are deposited. A flat surface is not appropriated at all for such an appreciation. Diffuse or specular transport of light between surfaces greatly modifies the material appearance and visual identification of paints even if we consider the metamerism phenomenon. At different spatial scales we can observe the effect of roughness (optical wavelength scale), waviness (macroscopic interaction scale due to brushstrokes for example) or at large scale the folds described by the shape of the coat. Each of these effects modifies the visual attributes, not only in hue but in lightness and saturation too. For illustrating the global effect and the influence on the digital camera recording, we prepared two virtual samples of painted surface. A completely flat sample of opaque paint with cinnabar pigments and a second one with a saw-toothed surface profile (figure 2) covered with the same paint. The calculated reflectance factors for normal conditions are sensitive to the large scale of the phenomenon where the spectral multiplication occur for the same lighting conditions.

The two normal reflectance factors are presented in figure 2). The flat sample will appear lighter than the saw-toothed surface and the late spectrum is shifted towards the large wavelengths and enriched in red components. It then appears darker and more brownish-red than the flat sample.

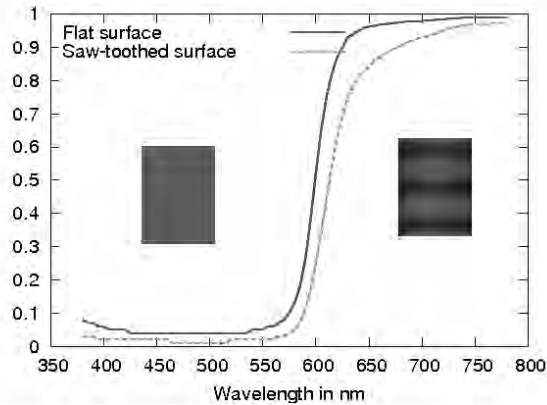

Figure 2: Reflectance factor of two samples of a cinnabardry paint film. The visual difference between a flat sample and a saw-toothed surface is shown. The saw-toothed sample surface will appear darker and brownish-red compared to the flat sample placed in the same lighting and viewing conditions. The small included pictures of the physical samples are superimposed beside the corresponding curves.

2.2 3D digitization

The first step in our reconstruction was the 3D digitization of the recumbent statue. We used, thanks to Francois-Xavier de Contencin, a structured light projector and a camera from Breukmann corp. (figure 3) for the whole statue acquisition. The work, realized in situ and after public hours, was executed without any contact with the sculpture and using non-invasive white light to prevent any damage to the strewn rests of the paint. This process produced 167 clouds of 3D points that were recombined to reconstruct the 3D surface.



Figure 3: Digitization of the recumbent shape using a structured light device.

The full resolution of the obtained 3D model is composed of about 7.5 millions triangles (figure 4).

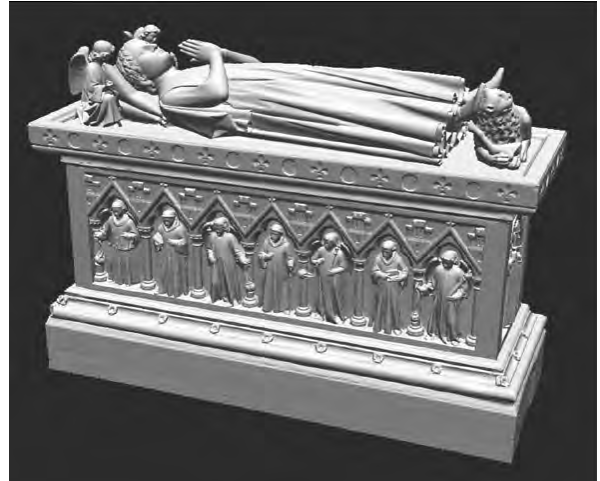

Figure 4: The obtained surfacic mesh with a very high level of detail. For rapid prototyping that high resolution is needed while for real-time display an under-sampled database is generated by a decimation process.

3. PAINT MODELING

The visual appearance of any material depends on its composition, state of surface, lighting conditions, ritual were procession and period, viewing situation and many other elements. Here we focus our attention on the pigmented layers. As previously published (Dumazet, 2008) three layers of paint observed on the statue.



Figure 5: An original set of indications on the polychromy of the recumbent statue of Philippe Dagobert and its canopy

The deeper one is, of course, the original one, dating from the XIIIth century. Our main interest lies in this original aspect retrieval. We examine in this section what are the parameters influencing color and appearance from the material point of view.

3.1 Influence of the paint composition and structure on the visual appearance

It is well known that the mixing of several kind of pigments in various proportions modifies the resulting color. Lightness is more sensitive to the pigments size distribution than the two other dimensions of color are. At the medieval epoch, the grinding of mineral pigments was hand made. The irregular shape and the large variability in pigments diameters give the paint a more interesting appearance than a very regular distribution as obtained today by a mechanical grinding. The scattering of light by pigments depends on their size and shape. The most advanced results on that subject are due to Simonot (Simonot et al., 2008). The absorption of light depends on the pigments origin and nature, via their complex dielectric functions (Callet, 1996, 1998). When there are several layers of paints deposited on a surface, the resulting visual appearance depends on the nature and thickness of each layer. The recumbent of Philippe Dagobert was painted twice during the XVIIIth and XIXth centuries. We previously measured by spectrophotometry the diffuse reflectance of all the visible remains of paint. More detailed results have been described last year in (Kartsonaki., 2007). It was not always possible to determine if the measurements were effectively made on XIIIth century paint layers or on more recent ones or even on an optical combination of stratified paints. For solving these undeterminations we took micro-stratigraphical samples. These informations on the nature of the pigments layers, the mean pigment diameters are necessary for the rendering model used hereafter.

3.2 The Kubelka-Munk model

We now use the acquired data concerning pigments nature and size for characterizing the absorption and the scattering of light by a paint film. For diffuse paints it is appropriated to use the very popular Kubelka-Munk model (1931 firstly formulated and later modified).

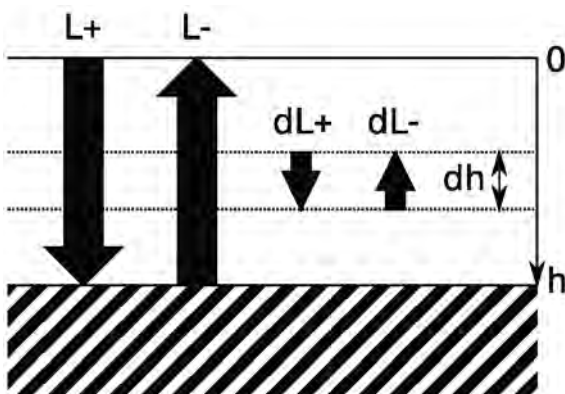

Figure 6: The phenomenological Kubelka-Munk 2-fluxesmodel and its parameters. The whole paint film thickness h fixes an opacity criterion, depending on the kind of pigments used.

The Kubelka-Munk model is a phenomenological construction, also called two fluxes model and mainly depending on two physical parameters (Callet, 2004): the absorption coefficient K and the scattering coefficient S . These functions are both wavelength dependent. The model permits the calculation of the scattering of light by an infinitesimal layer of paint.

The radiative balance effectuated for that elementary layer is generalized to the whole macroscopic paint film. The only two fluxes of light, travelling in opposite way inside the paint layer are: L^+ and L^- (see 6). The elementary variations of fluxes are written down as:

$$\begin{aligned} dL^+ &= ((K + S)L^+ + SL^-) dz \\ dL^- &= ((K + S)L^- + SL^+) dz \end{aligned} \tag{1}$$

The two parameters, K and S , that are of interest for us are obtained by spectrophotometric measurements on three samples prepared in laboratory. These samples have the same characterized physical background. We prepared three samples of different paint thickness: the first sample is made of only the surface support ($h = 0.0\mu\text{m}$). Relatively to a flat and white reference sample its Rbg reflectance factor is recorded ; the second sample is covered by a thin layer of paint. Its reflectance factor R and the thickness of the paint layer h are recorded; the last sample, a completely opaque layer of paint gives a reflectance factor R_∞ , always remaining unchanged when h increases. These three measurements are obtained thanks to an USB2000 device (OceanOptics corp.) operating in back-scattering mode. We also get the h parameter by measuring the mean paint thickness in an optical micro-stratigraphical image of the second sample. With these parameters we can calculate the reflectance factor of a paint layer of thickness h deposited on a perfectly black background:

$$R_{bk} = \frac{R_\infty (R_{bg} - R)}{R_{bg} - R_\infty (1 - R_{bg} R_\infty + R_\infty R)} \tag{2}$$

With h , R_{bk} and R_∞ , we can calculate K and S :

$$K = \frac{R_\infty}{h(1-R_\infty^2)} \ln \frac{R_\infty (1 - R_{bk} R_\infty)}{R_\infty - R_{bk}} \tag{3}$$

$$S = \frac{1 - R_\infty}{2h(1 + R_\infty)} \ln \frac{R_\infty (1 - R_{bk} R_\infty)}{R_\infty - R_{bk}} \tag{4}$$

K and S are wavelength dependent as previously mentioned and the color effect is mainly driven by absorption while lightness and more precisely the whitening of the paint surface is governed by scattering. Here, two scattering processes are simultaneously present : surface scattering due to the external surface roughness and volume scattering due to the light transfer between pigments inside the paint layer itself.

In the paint formulation the binder (water) has no influence on the dry material. The optical properties of a fresh or dry paint

are quite different due to the specular light mode of interaction with the film. We are only concerned with dry paints layers and consequently can ignore the index of refraction of the binding medium.

3.3 Reflectance factor calculation

With K and S , we can calculate the diffuse spectral reflectance factor of a paint layer with an arbitrary thickness h . We then have to calculate the spectral reflectance factor of a totally opaque layer according to the famous and simple relationship:

$$R_{\infty} = 1 + \frac{K}{S} - \sqrt{\frac{K^2}{S^2} + 2\frac{K}{S}} \quad (5)$$

Such a simple formula is responsible for the great success of the Kubelka-Munk model in many fields of industry for many years. Thus, we can calculate the diffuse reflectance factor of the desired layer:

$$R(h) = \frac{\left(\frac{1}{R_{\infty}}\right)(R_{bg} - R_{\infty}) - R_{\infty}\left(R_{bg} - \frac{1}{R_{\infty}}\right)e^{Sh\left(\frac{1}{R_{\infty}} - R_{\infty}\right)}}{\left(R_{bg} - R_{\infty}\right) - \left(R_{bg} - \frac{1}{R_{\infty}}\right)e^{Sh\left(\frac{1}{R_{\infty}} - R_{\infty}\right)}} \quad (6)$$

with R_{bg} the spectral diffuse reflectance of the substrate on which is deposited the paint layer. This representation allows us to compute a multi-layered paint system, by an iterative process. For a mixture of pigments, it is also possible to extract the resulting K/S by using the following approximation:

$$\frac{K}{S} = \frac{\sum C_i K_i}{\sum C_i S_i} \quad (7)$$

where K_i , S_i are the coefficients of each component of the mixture and C_i their respective volumetric concentration (called PVC in paint and plastics industries). It becomes possible, in the framework of these simple approximations to calculate the diffuse reflectance factor of any paint layer system.

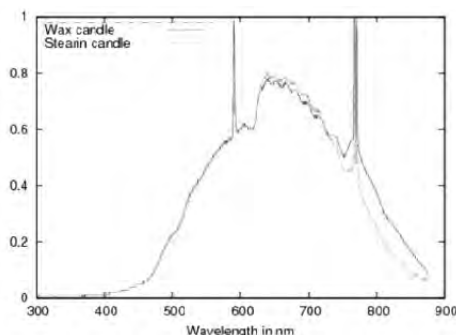

Figure 7: Emission spectra. Comparison between wax and stearin candles. A slightly visible difference lies mainly in the red and very near IR regions.

If some more accurate results are needed, different approaches to the scattering of light are employed. Using a 4-fluxes model, derived from the Kubelka-Munk one, by adding to directional fluxes of light, we can also integrate specular reflexion on metallic layers (Dumazet, 2008). Here, the role of the paint layer thickness is more comprehensive when we want to calculate the initial visual appearance of the blue Philippe Dagobert's overcoat. Today and already at the medieval epoch, the royal blue pigment was highly precious and naturally very expensive. Ultra-marine blue or Lapis-lazuli had to be used with a great attention. For that reason it was never deposited on a white background but on a blue one. In the case of our studied sculpture, that underlayer was realized with Azurite pigments (see [Dumazet et al., 2008]). One understands well now why the paint film thickness is required for the rendering.

4. MEDIEVAL LIGHTING

Having characterized the materials of the paint layers in the XIIIth century regions we need to find the most plausible lighting conditions in which the sculpture was placed inside the church. To do this, we decided to lead a short research on the medieval lighting devices: Natural light entering through the stained glass windows and the anthropogenic light radiated by the candles. Some excellent works were, in recent years, realized on medieval lighting [Bridault et al., 2006] mainly for realtime rendering and also in the modelization of fire [Nguyen et al., 2002]. All the authors pointed out the difficulties for measuring the emission spectra of flames. We got spectra for an unique observation region and three candles. For comparing the spectral distribution of the emitted light we used a set of wax

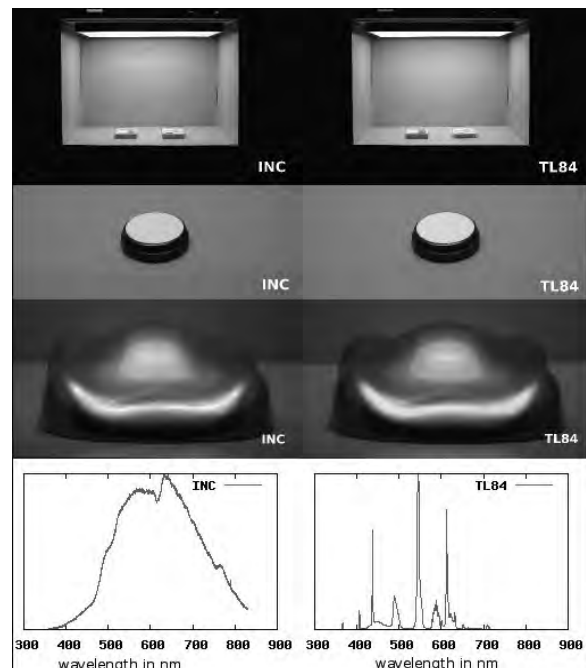

Figure 8: Digital camera images of the experimental setup for validation. The light box for visual experiments and spectrophotometric measurements under several illuminants is shown in the 2 upper images. CIE C and CIE TL84 are shown with their influence on the reference white, the medieval palettes of handcrafted paint and on a modern car shape painted with multilayered pigments (Merck KGa).



Figure 9: The stained glass window part studied in spectrophotometry. The work dating from the XIVth century is deposited for restoration. It exhibits few colored peripheral regions only.

candles and an actual candle made of stearin. One can verify the great similarity between the two spectra. The wax candle spectrum is slightly enriched in the large wavelength region. The two thin peaks correspond to the same chemical reaction. We shall study the influence of several wicks on the flame coloration. It is generally supposed that this element of the lighting device has no influence on the flame color. In figure 8 we can observe a similar emission spectrum for the CIE C illuminant and the emission spectrum of a wax candle except the two thin rays around 590nm and 770nm due to a common compound or becoming from the cotton wick.

The spectrophotometric results are presented in figure 7. As we previously mentioned the natural light entering the cistercian churches through the stained glass windows must not be altered. Royaumont seemed to be an exception to that rule as king Saint Louis wanted more impressiveness for the funeral sculptures of his family members. We are not sure if the stained glass windows were colored or not. The greyness of the glass, obtained by an overpainting called "grisaille" with few geometric drawings could be the wanted reference. We made several transmittance measurements on a stained glass window part deposited for restoration at the Laboratoire de Recherche des Monuments Historiques. That part of the stained glass window comes from the same region as the supposed original glass. We did not find any available stained glass window of the exact period that is of interest for our project. The studied material is nevertheless from the beginning of the XIVth century and does not seem to be so different from what we expected. Nevertheless, the transmissivity spectra will be used for the lighting simulation. At the opposite, if we suppose that king Saint-Louis constrained the monks to a polychromatic environment as well as in the painted recumbent and in the stained glass window, the lighting would have been quite different. The study is going on with the 3D restitution of the canopy and an important part of the chancel, useful for the ambient atmosphere and shadowing. The original glass composition is not exactly known. The actual glass composition is largely modified by several chemical alterations. For these reasons, the index of refraction is not determined. We attempt to find a plausible index of refraction and all the required absorption indices for rendering. A good approximation for the computation of the index of refraction is given by the Gladstone-Dale formula using several specific coefficients for the metal oxides compounds of the glass.

5. RENDERING WITH VIRTUELIUM

Virtuelium is an opensource raytracing software. The main characteristics of Virtuelium are: Spectral rendering in classical backward raytracing, global illumination with a special photon-mapping algorithm derived from (Jensen, 1999), use of the polarization of light, use of the complex dielectric functions of any materials, etc. The required optical properties of materials being involved in a simulation process are obtained in several ways of measurements e.g. by spectroscopic ellipsometry for thin films or metals and alloys (Callet, 2006). According to these methods and algorithms we decided to render a virtual copy of the real light box used for our experiments. The method and its inherent difficulties encountered for having a good visual comparison between the simulated materials and the corresponding digital image will be described in further publications.



Figure 10: The last considered hypotheses on the paint layers at the medieval era. The only recumbent statue is rendered here. The gilt ornaments are not still restituted for insufficient traces however the known drawings could help. Lighting with CIED65 illuminants. CIE 1964 (10°) colorimetric observer.

6. CONCLUSION

We have presented methods, measurements, algorithms used for attempting to render the original visual appearance of medieval sculpture. The general problem of rendering the original polychromy of a cultural heritage object leads to multidisciplinary projects. The presented project started by studying the material compounds of the sculpture. Thus, pigments identification by non-destructive technologies (mainly spectrophotometry), chemical and optical determination was made in the same time than the 3D digitization of the monument. In a second step we were concerned by lighting at the medieval epoch. For doing this we studied the lighting devices whether using natural or anthropogenic light sources. The validation of the whole process is a constant preoccupation for us in order to present not only nice computed images, that are of a scientific limited interest, but for having the most plausible vision of what was looking like the original art work. Nevertheless, the applied method is very promising for virtual restoration as well as for contemporary design.

7. REFERENCES

References from Books:

Callet, P., 1998. Couleur- lumière, couleur-matière – Interaction lumière-matière et synthèse d'images. *Collection Sciences en actes*, ISBN: 2-84-352-087-8. Diderot Editeur, Arts et Sciences, Paris, New-York, 320p.

RAPID PROTOTYPING & CULTURAL HERITAGE. THE CASE STUDY OF LOGGIA DEL MERCATO NUOVO IN FLORENCE

C. Battini

Facoltà di Architettura di Firenze, Dipartimento di Progettazione dell'Architettura
Viale A. Gramsci, 42, 50065, Firenze, Italia
Email: carbat@tiscali.it Tel: +39 055 200071

KEY WORDS: rapid prototyping, reverse engineering, scanner laser, 3D Print, modelling, digital survey

ABSTRACT:

The continuous technological development of the industrial world has always given some ideas and solutions to studies linked mainly to research and preservation of cultural heritage. For example the new survey systems as non-contact laser scanners have helped to expand the databases of useful information necessary for the protection of architectural heritage. In addition, the use of these digital data with techniques of Rapid Prototyping (RP) and Reverse Engineering (RE) have given inspiration to new ways of enhancing cultural heritage as well as providing new techniques of three-dimensional representation. In fact, these two methods of treatment which have given a strong contribution to investigation, know-know and diagnose all the changes that every work of art suffers with the passing of time. This article will present the result obtained from a digital scan useful not only to produce a scale model, but above all for the opportunity to make interactive archaeological assets with VRML model. The object in question is the Loggia del Mercato Nuovo in Florence, the so-called Loggia del Porcellino, which, after being detected with laser scanner, has been rebuilt with a three-dimensional model printed and presented in an exhibition.

1. INTRODUCTION

In this article it is presented the experimenting with a methodology of the three-dimensional representation of a physical object architecture. The continuous technological changes in industry have brought new systems of treatment and return of three-dimensional figure, able to reproduce the materiality and the shape of an object or an architectural complex, as well as to provide the basis for models made available through the web. Subject under consideration is the Loggia del Mercato Nuovo in Florence, particular architectural complex accessible from all sides and highly attractive. At the exhibition, organised by the Department of Planning Florence, covered with reliefs of digital Florence we were unable to produce a model printed of the Loggia starting from the data collected using laser scanner.

2. LOGGIA DEL MERCATO NUOVO

Built by G. B. rate (1547-51) for the sale of objects and precious fabrics, today is converted into a lively market of products of the Florentine craftsmanship. In the 1800 it was adorned with statues of Bernerdo Cennini, Giovanni Villani and Michele di Lando. In the side bridge the palace of the stock exchange goods there is placed the fountain of piglet, copy in bronze of Pietro notch of Hellenistic original marble today kept to the Uffizi. In the middle of the floor of the Loggia a wheel of marble (renewed in 1838) marks the place where in the Middle Ages, before the battles, was stopped the one stor, symbol of republican freedom, and where they were put to the merchants or shackles dishonest.

The structure is composed of 20 columns with capital composite and four pillars angles and four other pillars prepared on the sides shorter. Finally the coverage is defined by times sailing clothes spans square. The pillars angles have kiosks with statues.

3. THE RELIEF AND THE FIRST REVISION

Given the complexity of the object in question we had been planning the campaign of relief with laser scanners considering both the technology of instrumentation adopted and the particular morphology of Architecture in examination. In fact the many columns that define the spaces of the Loggia have required a high number of points of shoots in order to have a complete coverage of the complex.

The laserscan used in this campaign of relief* is the Leica HDS 4500, an instrument that allows rapid acquisition of the metric information and therefore the possibility to detect the object in a short time. The Leica HDS 4500 is a laserscan able to acquire from 100.000 to 500.000 point/sec with a shot of 360° on horizontal and vertical on East. The Leica HDS4500 can generate 1 gigabyte of compressed data in a single scan, representing about 15 minutes of real time and 200 million point samples. In addition to the 3D coordinate of the sample, a point may also have other properties. For example, colouring each point based on the true colour from a digital image can aid visualization. HDS scanners also measure and record the "intensity" (strength of the return signal) of each sample. For example, surfaces that absorb the laser have lower intensities than surfaces that reflect the laser. Other factors that can affect the intensity include specularity, surface colour, and distance to the scanner; the ambient light in the scene however does not affect the intensities.

Thus the data collected were registered to obtain a single point cloud, the basis of subsequent processing. In fact the result was a three-dimensional reconstruction of the Loggia having as a reference the cloud of points gathered. The large amount of

* Credits: Scanner laser operators: Carlo Battini, Giovanni Guccini, Marco Miccoli, Tzeni Nomikou, Federico Piras, Filippo Susca, Francesco Tioli, Sergio Di Tondo, Giorgio Verdiani.

information collected was at first analysed and decimated, seeking to delete all the repeating information that were created when the various stations taken had been put in the register causing overlap and duplication. Subsequently were created the geometries that reproduced faithfully the Loggia using modelling program as Rhinoceros (Mcneal) and other programs of computer graphics able to reproduce, in addition to geometry, the material of the object in question.

The processed products are both three-dimensional views, even with unusual points of view, and the classic two-dimensional performances (figure 1).



Figure 1: Model produced by Marco Miccoli, Tzeni Nomikou, Federico Piras.

4. THE CONSTRUCTION OF THE MODEL VERSION

In occasion of the exhibition “Nuove immagini dei monumenti fiorentini. Rilievi con tecnologia scanner laser 3D” we have produced some three-dimensional models printed in order to experience the methodologies and processing of data collected, and to make more visible some Florentine architectures, or parts of them. The preparation to produce a physical model copy of the original is that of Rapid Prototyping PR, the technology to reproduce in solid form the mathematical model done on a CAD three-dimensional system*. The techniques used in the construction of a physical model may be varied, all acting in accordance with the concept of addition, or going to settle successive layers of material. The advantage of this type of processing is obvious if you take into consideration for example a statue, where the numerical control machines show their difficulties. In fact the machines as mills, which work building the model from a block and being the material, show their deficit in front of the large amount of data that the software of management must process in calculating the route that the tool

must follow. In addition a CNC** machine doesn't shows performing in the presence of strong under team, which require a strong work of manual post-processing. At the same time, the rapid prototyping additive presents its deficit in the creation of objects that may not have the same features material as the real purpose. It is precisely because of the nature of the materials used (dust, liquid, solid) that so far it has not reproduce faithfully reproduce materials like stone or marble. The result of a PR will be a model "Equal" to the original unless its features are purely material. Then we analysed the model previously drawn up, focusing attention on some of the parties that had problems for possible press 3d. There are some basic rules in the case in which is modelled a three-dimensional object that can subsequently be prototype, rules that are not essential in the field of the refund two-dimensional but that can resolve considerable problems in PR.

These type of problems are commonly:

- density of the mesh created; the number of polygons that are a 3d model must be such to describe the changes of curvature of the areas that make it up without being visible in press (figure 2)

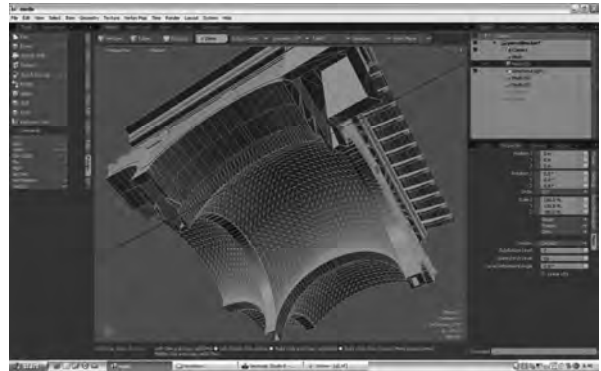

Figure 2: Particular of the model in the three-dimensional modelling with highlighted the viewing wireframe that composes the model

- interruption of the development of the normal of polygons; the presence of this error may, in the phase of the press, highlight alteration of the areas and the union of parties that should be divided
- creation of polygons with more than four summits; the format STL*** polygonal is a format that requires a mesh triangular (figure 3-4)
- overlapping; this term indicates the presence of triangles superimposed that generate alterations in press
- holes; contrary to the classic modelling, the 3d model for prototyping must not present holes.

* The birth of rapid prototyping must to the idea of Charles W. Hull that, in 1986, coined the term of stereolithografia within its US patent 4,575,330 entitled 'apparatus for production of three-dimensional objects by stereolithography'.

* * Acronym of computer numerical control. This is define those machines, which, controlled by a computer, are able to achieve engravings milling in the round with a high degree of detail and precision.

* ** Standard triangulation language to layer. Extension of rescue used by software for rapid prototyping. As shown by definition, the 3d model is composed of triangles.



Figure 3: Particular angular. Control of the areas with highlighted the polygons reversed superimposed or not continue

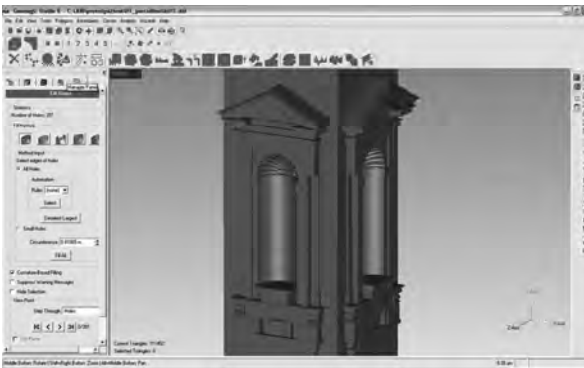

Figure 4: Particular of the model. Mesh corrected and ready to be printed

The procedure to achieve the prototype of the Loggia of the new market is summarised in four distinct stages: creation of the file STL, the management of STL file, press the 3d model, post-processing.

After having created the file STL and controlled in all its parts in a way that does not have problems in print, we shall now proceed to the third stage, or to the stage of the press 3d with the technology adopted. In our case, the choice was the press additive type 3d printing.

This process of the press is based on deposition of layers of dust that are glued only where it is necessary. During the process are then draw sections of the model with the glue. At the end result is a tub of powder with an internal model seeds drive. Once the press and cleaned up the model of excess powder, we proceed with the fourth and last phase of the hardening and the adjustment to the material pasted. In our case we have provided of joints of the model and the mild paint to give the material a white colour less strong and intense.

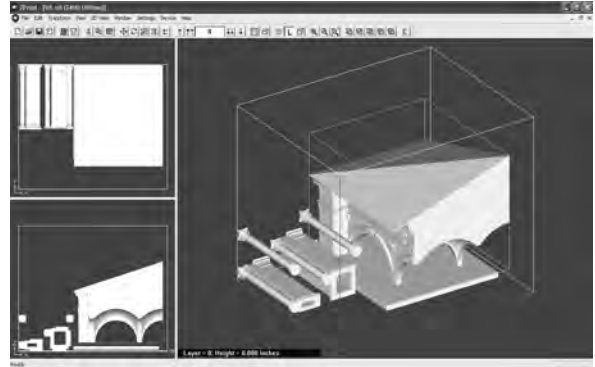

Figure 5: Software used to print

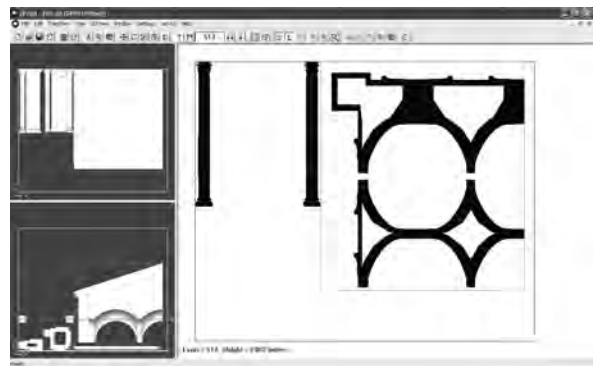

Figure 6: Particular of section of the model



Figure 7: Single parts of the model

5. CONCLUSION

These small experiments carried out by the laboratory of relief have allowed some considerations about the possibility and the use of this technology in the field of Cultural Heritage. The procedures still are not fully standardised and need people with strong knowledge in the field of modelling that still makes use of the press 3d A SYSTEM very widespread in the world of Cultural Heritage. In fact, the pipeline is operational only similar to the one used in the industrial world, as when assessing a sculpture or a architecture involved a series of problems relating to within not geometries in standard form.

It is desirable in a future that manufacturers of both software and hardware will be able to simplify these procedures making easier the creation of copies of works of art in order to be exposed and viewed by an increasing public.

The compound model can also be used to be saved in format VRML and used in web portals.

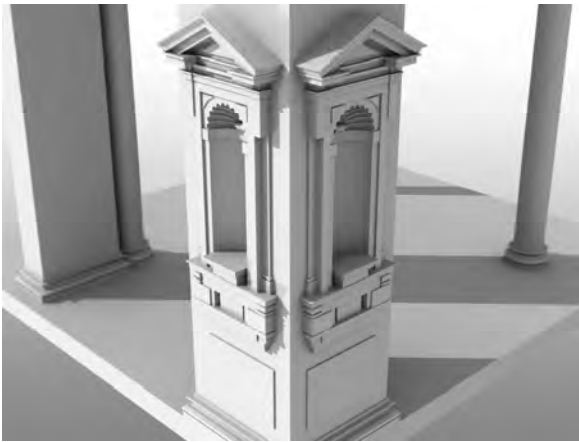

Figure 8: View of the model recomposed



Figure 9: View of the model recomposed



Figure 10: View of the model recomposed

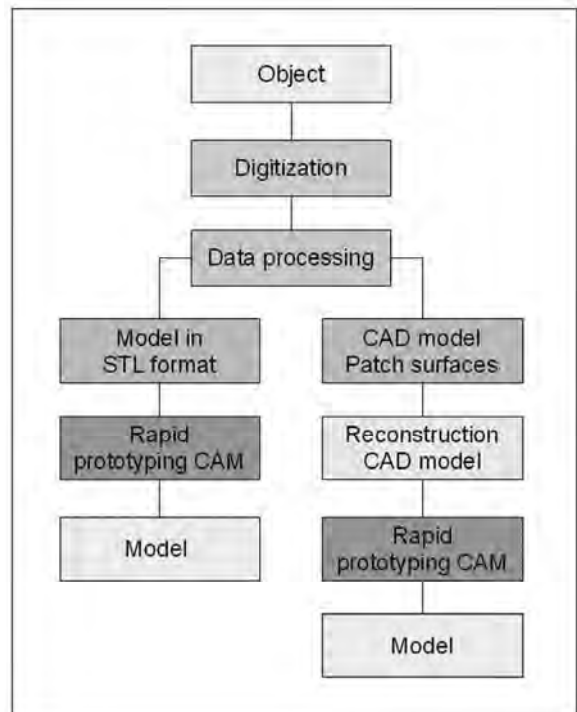

Figure 11: Schema of the process

6. REFERENCES

Battini C., Fantini F., 2007. *Modelli Tattili; una questione di rappresentazione*. In: Bini M., Battini C., *Nuove immagini di monumenti fiorentini. Rilievi con tecnologia scanner laser 3D*, Alinea, Firenze, pp. 36-39.

Di Tondo S., Verdiani G., 2007. *Tecnologie laserscan per il rilievo monumentale*. In: Bini M., Battini C., *Nuove immagini di monumenti fiorentini. Rilievi con tecnologia scanner laser 3D*, Alinea, Firenze, pp. 32-35.

Bonora V., Tucci G., 2007. *Application of high scanning system for virtual moulds and replicas of sculptural works*. In: *The ICOMOS & ISPRS Committee for Documentation of Cultural Heritage. CIPA 2007. XXI International Symposium*, pp. 721-726.

Waggoner T. C., 2007. *Reverse engineering architectural hardware*. In: *The ICOMOS & ISPRS Committee for Documentation of Cultural Heritage. CIPA 2007. XXI International Symposium*, pp. 726-732.

3D COLONIAL PHILADELPHIA: DIGITAL DOCUMENTATION AND RECREATION OF AMERICAN HERITAGE

C. P. Redmann^a

^a Digital Media Program, A.W.CoMAD, Drexel University, Philadelphia, PA, redmann@drexel.edu

KEY WORDS: Virtual Heritage, Education, Modelling, Animation

ABSTRACT:

The project described in this paper involves the use of digital technologies in the documentation and recreation of several colonial American sites around Philadelphia. These sites include the James and Ann Whitall house in Red Bank, New Jersey; the James Oronoko Dexter house in downtown Philadelphia; and the the Mill at Anselma in Chester County, Pennsylvania. Emphasis in recreation was placed on accuracy of the representation, to avoid propagating misinformation and to present the most complete idea of the structures. Working with local archaeologists and faculty, digital media students have successfully constructed digital models of these sites for presentation in various formats.

1. INTRODUCTION

1.1 Introduction

The Digital Media Program at Drexel University is currently involved in a large-scale digital recreation project, 3D Colonial Philadelphia. The intent of the project is the digital recreation of a number of historically significant structures and locations in and around the Philadelphia area, for use in a number of situations. Often, there is not enough information available for a physical recreation of the structure, and a digital reconstruction easily allows for partial development of a site. Even if the information is available, a physical structure may not be feasible for spatial or economic reasons. In these cases, a digital recreation will allow for user interaction with a structure, without the need for a physical reconstruction.

Other advantages of digital recreations include the ease of reuse, and the ability to simply adapt and update the models as more information becomes available. A single model can represent various points in time, and allows the layering of multiple possibilities and speculations on historical data. Digital methods of recreation also lend themselves to various content delivery methods, for use both on and off site.

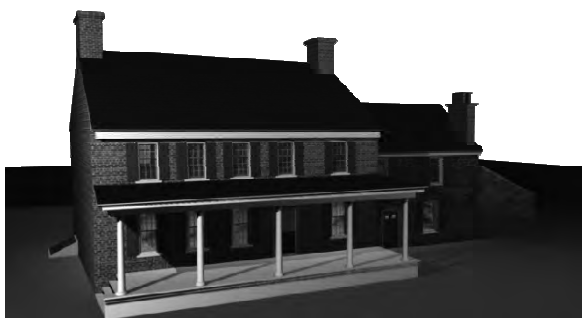

Figure 1: Whitall House Reconstruction

Working with students and Dr. Glen Muschio, the Digital Media program has begun the digital documentation of a number of structures for use in education and preservation of Colonial American history. This paper presents an overview of

the technological methodology and status of several of the current projects in development.

2. CURRENT PROJECTS

2.1 James and Ann Whitall House

2.1.1 Initial Work: The first project undertaken by the 3D Colonial Philadelphia project was the recreation of the James and Ann Whitall House, located in Red Bank, New Jersey. (Figure 1) Due to the significance of the site during the Revolutionary War, and the ease of access to the house, it proved to be an ideal location. In addition to full access to the property, drawings of the house had been made by the Historic American Buildings Survey (HABS), beginning in 1934 completed in 1935. These eighteen drawings provide detailed information about the overall layout of the house in section, plan and elevation. (Figure 2) Also completed during the survey

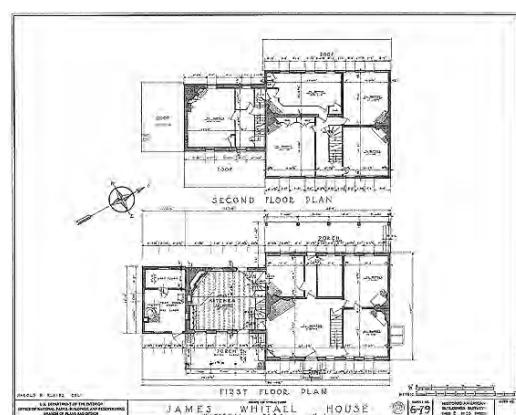

Figure 2: HABS Drawing, Whitall House

were sheets of hardware measurements, moulding profiles, and interior features. These drawings also provided an initial layout of the site detailing the location of the house and adjacent Fort Mercer. It should also be noted that the line of the river bank has changed due to dredging of the Delaware river, and the HABS drawings indicate a closer line to that when the house

was built. The plans show the house as it stood during the time of the survey, rather than the original house of 1748, so the decision was made to use 1934 as the time of reconstruction, since the source materials were available. One of the reasons for creating digital assets of these historic structures is the ability to represent multiple time periods by making adjustments to the 3D model.

Work on the digital reconstruction was begun by Digital Media student Adam Finger, prior to any site visits to the house. By initially focusing on a small, interior space in the house, we were able to get a sense of some of the difficulties that would arise. From the information in the HABS drawings, the Common Room was reconstructed using Autodesk's 3ds max. The intent of the digital model is to provide the most faithful reconstruction possible, so all hardware details were fully modelled, without resorting to the use of texture or displacement mapping. Further uses of the model could easily lower the resolution of the constructed elements, but it would be inefficient to add detail at a later date. Various household items were created by student Anna Kotelnikova to populate the scene, as an initial test of the translation of items without detailed drawings from the site into the digital model. (Figure 3).



Figure 3: Whitall House Common Room Rendering

Following the construction of the Common Room, the remainder of the first floor was roughed out for the creation of an interactive walkthrough of the space. This was done to demonstrate the gaming possibilities of the project, and was executed using the game engine Havok. The avatar in the simulation could interact with walls and floors, and had the ability to collide with furniture using simple dynamics interaction. (Figure 4)

2.1.2 Difficulties: As the first case of reconstruction, a number of understandable difficulties arose. As Digital Media students have limited exposure to architectural notation schemas within the curriculum, the HABS drawings proved difficult to comprehend initially. Also, only after a physical visit to the site was there a true comprehension of the space, which could not be ascertained through sole use of the drawings. Other problems involved student understanding of historic construction methods; floor planking was originally modelled with consistent widths throughout the house, despite colonial construction widths from the house typically varying from eleven to sixteen inches. Another problem faced was the representation of surface materials throughout the house. The most common method of photorealistic texture mapping is

photogrammetry, but initial site photographs proved too low-resolution to be useable. Due to this, repetitive patterns were evident in the final rendering requiring later reshooting of the photographic textures. Inconsistent lighting in the photographs also prevented accurate relighting of the models, which was also remedied by reshooting. For wall textures, paint color was sampled from the physical structure and applied through the use of a BRDF paint shader.

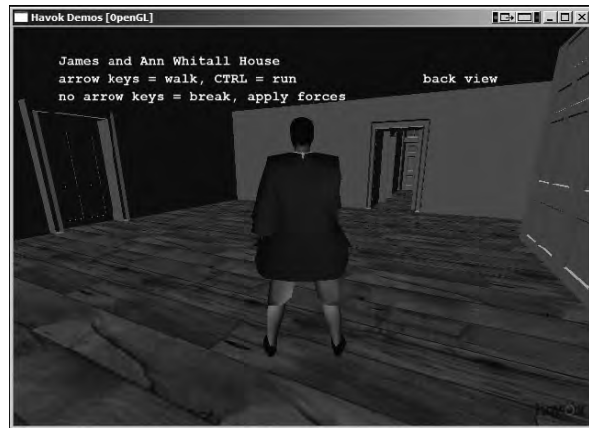

Figure 4: Havok Interactive Demo

2.1.3 Secondary Stage Work: After the initial test model was completed, work continued on the reconstruction of the remainder of the first floor of the Whitall House. The next rooms constructed were the Field Hospital, Parlor and the Kitchen; work was done by Digital Media students Kristy Pron, Michael Sausa, and Steven Viola. To overcome some of the problems encountered during the initial phase of the project, an earlier site visit was arranged for the involved students, to allow a more comprehensive understanding of the space. As this was the first instance of multiple students working on distinct spaces within the same structure, additional problems arose. Various working methods, including location of the rooms within "world space" and polygonal modelling techniques, created problems in registration of the various elements. Also, the initial level of detail from each student varied, leading to an inconsistent look for each room of the house. (Figure 5) Accuracy of the models also suffered during this phase, due to rushed work and lack of attention to detail. Modelling was also transitioned from 3ds max to Autodesk's Maya, which caused some translational issues.



Figure 5: Second Stage Render

Modelling of the exterior of the house began, indicating further problems with distinct room alignment; window and door heights varied throughout the model, requiring extensive reworking of the rooms. Further development of the project resulted in a website designed to inform visitors about the current and historic states of the house and adjacent site of Fort Mercer. As a part of a Digital Media senior project, www.whitall.org was launched, incorporating contemporary and historic recreations of the house and topology. Care was taken to represent that landscape, and specifically the shoreline of the Delaware River as it was during the construction of the house in 1748.

2.1.4 Continued Interactivity: Technical limitations of consumer computer graphics hardware and time of production made the Havok game interaction too difficult to achieve on a broad scale. Other methods of interactivity were explored, and a hybrid model of QTVR and pre-rendered QuickTime movies was arrived upon. Using the existing models, Digital Media graduate students Chester Cunanan and Matthew Smith developed an Adobe Director based executable that allowed for playback of movies when moving from room to room, but exploratory interactivity through QTVR while the visitor was situated within the space. This hybrid approach also lent itself to platform independence, as the Director projectors could be played back from either Windows or OS X. While this approach does not give the full interactive presentation of the 3D game engine, small file sizes and low hardware requirements make it ideal for broad presentation. However, as gaming hardware becomes more accessible, this may not present a problem in the near future.

2.2 James Oronoko Dexter House

2.2.1 Initial Work: The James Oronoko Dexter house was located in downtown Philadelphia, in what was known as "Block 3" near Fifth and Arch Streets. After a 2004 excavation of the site by the National Park Service, the foundation was delineated and a number of artefacts were recovered. Working with Doug Mooney of Kise, Straw and Kolodner, and Jed Levin from the National Park Service, Digital Media student Sean Brown began a digital recreation of the structure. Beyond the archaeological evidence, tax and insurance records were used to gain further insight into the detail of the structure. As very little was known about the house, work focused on the recreation of the exterior shell and its location within the greater site. Photographs of contemporary houses and extant structures from the same time period also provided reference for the digital reconstruction details. (Figure 6)



Figure 6: Initial Dexter House Model

2.2.2 Secondary Stage Work: As with the Whitall House, the initial model was revised after more information was uncovered. Much of the information about the original model was derived from recent excavation work, so subject matter experts were consulted to discuss the inaccuracies of the original model. Some of these included the size and position of the chimney, the location and scale of windows, brickwork, and the location of the kitchen on the rear of the house. Working from the initial reconstruction, Chester Cunanan created a second version of the structure, reflecting the updated information about the house. In addition to the changes to the structure, more detail was added to the house, to create a more comprehensive interpretation of how it could have originally appeared. (Figure 7)



Figure 7: Revised Dexter House Model

2.3 Mill at Anselma

2.3.1 Initial Work: The Mill at Anselma is located outside of Philadelphia in Chester Springs, Pennsylvania and was originally constructed circa 1747. The mill was recently historically renovated, and the entire drive train was updated to resume milling activities. The workings of the mill are located on three floors of the structure, and access to the public is quite limited. The third floor of the structure is completely off limits, and the water wheel is physically separated from the main body of the gearing. As part of a pilot program, Digital Media graduate student Arvind Neelakantan began a recreation and animation of the drive train in action. This animation would allow visitors to see all aspects of the mill workings, which would be impossible from a physical site visit. (Figure 8) Future work on the project has been suspended, pending further grants.



Figure 8: Mill at Anselma Drive Train

2.4 Fort Mercer and the Battle of Red Bank

2.4.1 Initial Work: The Battle of Red Bank took place at Fort Mercer, which was adjacent to the Whittall House and involved a skirmish between Colonial revolutionaries and a Hessian regiment under the control of the British Army. Given the significance of the battle in the tide of the Revolutionary War and the proximity to the Whittall house, a digital reconstruction of the fort and a simulation of the battle were undertaken. Fort Mercer was an earthen fort, so much of the reconstruction was simply modification of the terrain to describe the earthworks and defensive elements, such as abatis and pikes. Digital Media graduate student Sara Colucci worked on the modelling of the fort (Figure 9), and James Grow modelled armaments such as rifles and cannons which were also used in the model of the H.M.S. Augusta.

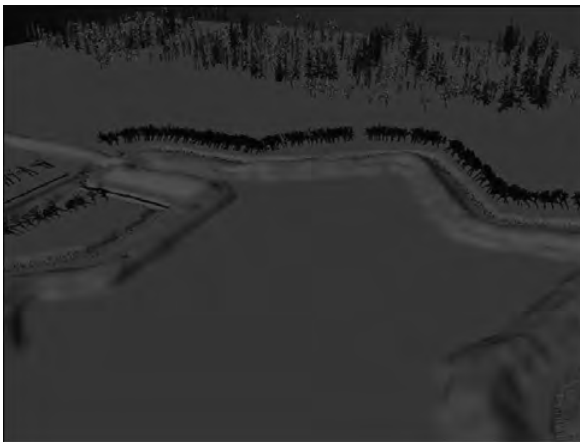

Figure 9: Fort Mercer Overview

2.4.2 Battle Simulation: In addition to the model, a rudimentary crowd simulation was developed to recreate the actual battle scenario. Massive Software's Massive Prime was used to create the "brains" for the simulation and an initial character model was developed and animated by graduate student Justin Dobies. (Figure 10) This proved to be quite ineffective, as the character animation was not of sufficient quality to provide convincing movements.



Figure 10: Animated Colonial Soldier

2.4.3 H.M.S. Augusta: The British ship, the H.M.S. Augusta was also involved in the battle, and an initial recreation was completed by Chester Cunanan and Matthew Smith. Emphasis was placed on the rigging and armaments, as well as the destruction of the vessel during the battle. Subsequent research has indicated the current of the model is quite inaccurate, and future work will involve remodelling the ship to maintain historical accuracy. (Figure 11)

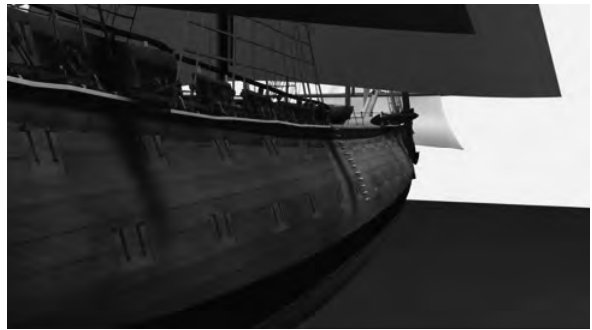

Figure 11: H.M.S. Augusta Model

2.5 Future Work

2.5.1 New Technologies: Recent technological acquisitions by the Digital Media program will create new possibilities for the 3D Colonial Philadelphia project. A Minolta 3D laser scanner is currently being used to scan artefacts from the Independence Mall excavation, and will allow the digital models to be populated with accurate representations of everyday Colonial life. While this technique is useful for extant structures and physical artefacts, it is still necessary to model objects and buildings that are known only from documentation. In addition to the modelling, a fourteen camera Vicon MX-3 motion capture system will be used to capture significant quantities of soldiers' movements to be input into the battle simulation.

2.5.2 Procedural Neighbourhoods: Work has begun on building a comprehensive database of door and window types, contemporary to the Dexter house and encompassing Block 3. Using procedural modelling tools, such as Side Effects Software's Houdini, entire neighbourhoods indicative of the time period can be recreated. These can then provide the basis for future interactive work, including full artificial intelligence based games populated with characters and artefacts, allowing for an immersive learning experience.

3. CONCLUSION

The use of digital models allows for a great deal of flexibility, both in terms of representation and methods of distribution. The digital assets are currently being used in the development of teaching tools for fourth grade students in southern New Jersey, and the hope is to expand their use to other schools. The possibilities for interactivity and depiction of this era of Colonial America are truly vast, and we hope to continue to expand and build on this exciting project.

PLAYING “DOLL HOUSE” IN THE MUSEUM: THE USE OF 3D SCANNING AND RAPID PROTOTYPING TECHNIQUES FOR PRODUCING SCALE MODELS OF SCULPTURES

G. Celani^a, R. Pupo^a, V. Piccoli^b, J. V. L. da Silva^c, M. F. Oliveira^c,
A. Jardini^d, L. Cancherini^a, S. Skoda^e e R. Marques^e

^a Department of Architecture and Construction - School of Civil Engineering, Architecture and Urban Design/P.O. Box 6021, University of Campinas – UNICAMP - Campinas, SP, Brazil
(celani, rpupo)@fec.unicamp.br, lauracanc@hotmail.com

^b Pinacoteca do Estado de São Paulo - vpiccoli@pinacoteca.org.br

^c CenPRA, Renato Archer Research Center - jorge.silva@cenpra.gov.br, marcelo.oliveira@cenpra.gov.br,

^d School of Chemical Engineering, UNICAMP - jardini@lopca.feq.unicamp.br,

^esoniaskoda@yahoo.com.br, r_marq@hotmail.com

KEY WORDS: 3D scanning, rapid prototyping, digital fabrication, sculpture modelling, exhibition planning.

ABSTRACT:

The present paper presents an undergoing project in which scale models of a museum’s sculptures are being produced, to help curators in the planning process of new exhibitions. A review of some 3D scanning techniques was carried out with the objective of selecting appropriate and economically feasible methods for digitizing different types of sculptures. The geometric models generated will be used for digitally fabricating scale models of the sculptures with rapid prototyping techniques. The project is being carried out by an interdisciplinary team, in which museum curators, artists, engineers and architects are working together. We expect to establish a methodology that can be used in other museums in the nearby future.

1. INTRODUCTION

One of the countless applications of technology in cultural heritage is digital fabrication. The present research is part of an undergoing project in which digital fabrication techniques are being used not just as a representation technique, but as an effective planning resource for an art museum in São Paulo. A 1:25, fully furnished, scale model of the permanent exhibition rooms of the museum is being produced, with the aim of helping curators and exhibition designers to experiment with the location of paintings and sculptures in a collaborative way, for planning new exhibitions. The project includes the use of different fabrication techniques, such as rapid prototyping.

The present paper is related to the part of the project in which scale models of the museum’s sculptures will be produced. The production of these models will comprise three steps: (1) digitizing the sculptures, (2) preparing the data for outputting, and (3) fabricating the models.

At this moment, a research is being carried on to find out the available technologies and to determine the best way to obtain digital models of the sculptures. Different techniques will be tested and compared in terms of cost, difficulty of use, and adequacy to different sculpture types and sizes. The results will also be compared in terms of difficulty in the preparation of the acquired data for output. Finally, the results will be prototyped with different technologies and compared in terms of cost and quality of representation.

The team that is carrying on the present project is composed of people from different institutions and of different levels, from undergraduate students to senior researchers. It includes:

A curator from Pinacoteca do Estado, a museum owned by São Paulo state;

Professors and students from two laboratories of the University of Campinas (UNICAMP) another São Paulo state institution:

1. the Automation and Prototyping for Architecture and Construction Laboratory (LAPAC) of the School of Civil Engineering, Architecture and Urban Design (FEC);
2. the Optimization, Project and Advanced Control Laboratory and the Laser Laboratory of the Chemical Engineering School (FEQ);

Researchers from the Rapid Prototyping Laboratory of the Renato Archer Research Center (CENPRA), a federal-funded institution.

2. THE MUSEUM

Founded in 1905, Pinacoteca do Estado was the first art museum to open its doors to the public in the city of Sao Paulo, Brazil. It is today one of the largest museums in the country, with an area of approximately 4.000 sq m (43.000 sq ft), a 6.000 works collection of 19th and 20th century Brazilian art and more than 20 exhibition rooms. Pinacoteca is installed in a historical building located in São Paulo’s downtown, next to the city’s main train station, Estação da Luz. The three-story, classical style building was designed by a famous Brazilian architect, Ramos de Azevedo (1851-1928), and built in the final years of the 19th century, as State School of Arts and Crafts, but it was never completely finished. In the 1990’s, the Museum director, Emanoel Araujo, hired architect Paulo Mendes da Rocha to completely remodel the building, adapting it to contemporary museum space standards. Nowadays temporary exhibitions are displayed on the first floor, and the permanent collection is shown on the upper floor. Technical areas are located on the ground floor.

One important challenge to be faced by Pinacoteca's curatorial team in 2008 will be the remodeling of the permanent collection exhibition. The exhibition that currently occupies the upper floor of the museum is more than 10 years old and needs to be modified not only in terms of the works on display, but also regarding the communication of the exhibition (wall texts, labels and multimedia). In this context, the model that will be made by LAPAC will be an instrument of great relevance, as it will allow the curators to have full control of the narrative they are trying to put up without actually moving the works from place to place. The scale was carefully chosen to enable the analysis of the relationship between the works of art, considering their particularities of technique, dimensions, mounting, framing, etc.

Since the new exhibition has primarily to deal with the best of the museum's collection, displaying pieces from early 19th century until contemporary art, the project will be developed by different teams, which will work according to their area of expertise. One important requirement for the making of the model is the possibility to work with it in separate parts – in a way that each team could be able to study and make propositions for its section – still keeping the connection to a master plan.

The project for redesigning the layout of Pinacoteca's permanent collection will begin with the production of a model of the 2nd floor of the building to be used by the curatorial team. It includes also a series of interviews with the public of the museum as well as with specialists invited to give their opinion during the process. The new exhibition is intended to be on view in 2010, when the museum celebrates its 105th year of existence.

2.1 The sculptures collection

The museum's collection of sculptures comprises 100 objects, dating from 18th to 20th centuries. According to their geometry, the sculptures can be categorized in four main types:

Anthropomorphic and zoomorphic sculptures (Figure 1);
Geometric sculptures (Figure 2);
Sculptures made with everyday objects (Figure 3);
Free-form sculptures made with wires or other materials (Figure 4).

Among the types above, the latter may be of greater difficulty to produce. Another possible difficulty is related to the colour of the sculptures. Dark-coloured objects are more difficult to scan, and often require the application of a white powder spray, which is a delicate question when working with artwork and cultural heritage.



Figure 1: Anthropomorphic - "Sapho", by Silva (undated)



Figure 2: Geometric - "Active object", by Castro (1962)



Figure 3: Everyday objects - "The pig", by Leirner (1967)



Figure 4: Free-form - "No title", by Carvalhosa (2000)

Other aspects that may influence the choice of 3D-scanning techniques are the material and size of the sculptures. Transparent materials, for example, are particularly difficult to digitize, and may require a different type of technology. Thin materials, such as wires and strings, may be possible to 3D-scan, but impossible to 3D-print at the required scale, due to resolution limitations of rapid prototyping equipment. In regards to size, the sculptures of the museum range from approximately 15 cm to almost 4 m. Certain equipments can only handle objects of a limited height or length, while other technologies may not be sufficiently accurate for handling very small sculptures. For this reason, different data acquisition technologies will need to be tested. Examples of possible challenges in the digitalization process are:

Transparent material - made of plastic straws inside a transparent acrylic box (Figure 5);
Large size sculptures and dark materials (Figure 6);
Small size sculptures (Figure 7);
Thin materials (Figure 8).



Figure 5: Transparent material - "Ashes", by Pazé (1962)



Figure 6: Large size sculpture and dark (black) material - "La Porteuse de Parfum", by Brecheret (1924), 3.4m height



Figure 7: Small Size sculpture - "Villager's head from Capri's Island", by Bernardelli (between 1877-1885), 20x12 cm



Figure 8: Thin material - "No-title", by Castro (1983), ½' thick

3. DIGITIZING

Digitizing is representing an object by means of a "digital representation", as opposed to an analogical representation, which could be a hand sketch or a scale model. In other words, it means reproducing or describing something that exists in the real world with some sort of digital data that can be stored in the computer*.

Table 1 shows two different types of digital representations of the same "real world" object - a digital image and a geometric model of a cube - and the differences between them in terms of what is seen on the screen and what is stored in the computer's memory. Digital images are stored as a 2D matrix of colored (or grayscale) dots. Each dot is represented in the memory by a number that specifies its tonal value. Geometric models, on the other hand, are stored as a series of vectors that describe the object's geometry in 3D space. The major difference between these two types of representations is the fact that in the former the computer "does not know" that the picture represents a cube, while in the latter the computer "does know" that the model is a cube with certain dimensions, angles and volume.





	Digital image	Geometric model
Visualization on the computer screen		
Data stored in the computer's memory		
File format	BMP, JPG, GIF, etc.	DXF, DWG, STL, etc.

Table 1: Two different types of digital representations of the same "real world" object

There is also a big difference between the methods for obtaining the two types of representations above. Digital images of "real world" objects are obtained with digital cameras. When the light coming from an object enters the camera through the lens, it hits a photoelectric light sensor or CCD (charge-coupled device), which converts the optical image into electric signals pixel by pixel. The value corresponding to each pixels is then stored in a matrix, in digital format.

Geometric models of real world objects can be obtained "manually", semi-automatically and automatically. In the "manual" method the user measures the "real world" object (with a measuring tape or other manual measuring device) and then uses a CAD program to produce a geometric model of the object, by entering the measured values. This method is quick

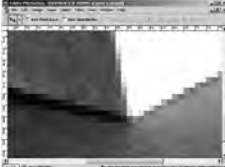
* For a further discussion about digital representations, see Mitchell, 1990.

** The word "manually" is used with quotes because although the geometric model is developed with a computer program it is done step by step by the user, with direct input of data, usually with a mouse and a keyboard.

and easy if the object has a simple geometry, but it can be very time-consuming if the object has a complex geometry.

In the automated and semi-automated methods both the measuring and the geometric modelling are made with little or no intervention of the user. There are two main types of automated methods: contact and non-contact. Among the non-contact methods there are two sub-types: by direct measuring and by image interpretation. The automated and semi-automated methods are much quicker than the manual method, especially for modelling complex surfaces.

The contact method uses a coordinate measuring machine (CMM), which is a mechanical digitizing device. This type of device has a measuring probe that must touch different points of the object to send their coordinates to a computer. There are two main types of CMMs: articulated and flatbed. In the former, the probe is at the end of an articulated arm, which must be manually positioned on different points of the object by the user. In the flatbed CMM the object lays on a horizontal surface while the probe inspects it automatically, sliding along the X and Y axes, and going up and down as needed. The flatbed system is usually quicker than the mechanical arm, but it cannot access negative sloping planes. Both contact methods are slower than the non-contact methods. Besides, the contact of the mechanical probe may scratch or damage delicate objects, therefore, this type of method will not be used in this study.

Non-contact methods use a device that emits some kind of radiation on the object and detects its reflection. Their main advantage is the fact that they do not damage the object being scanned, although in some cases it may be necessary to spray it with a whitening powder, to improve reflection. Different types of radiation can be used for probing: white light, laser light, infrared, ultrasound, x-ray, etc. Some methods allow acquiring data even from inside a closed object, such as magnetic resonance imaging (MRI) and tomography. Tomography has been used, for example, for modeling mummies inside closed coffins (Santos et al., 2004). The cost of this method is usually high, but it is fast and accurate.

In some of the non-contact methods the radiation, usually a laser beam, is used for directly measuring the distance between the scanning device and the object. The distance is calculated by measuring the time that it takes for the beam to hit the object and return to a sensor on the scanning device. This method, called time-of-flight, allows scanning very distant objects, such as entire buildings, and is commonly used in architectural, archaeological and terrestrial surveying (see, for example, Gambino et al., 2006). For this reason, this type of digitalization will also not be used in the present study.

The second type of non-contact scanning is based on image interpretation. There are three main types of image-interpretation methods: laser triangulation, stereoscopic and structured light. Automated image interpretation is a field that overlaps photogrammetry, computer vision, artificial intelligence (AI) and pattern recognition. Although the image interpretation methods do not necessarily require expensive equipment, the software may be very expensive. However, there are alternative programs, which certainly have many limitations, but are less expensive.

In the laser triangulation method a laser line is projected on an object at a known angle. A camera positioned at a known distance from the laser's source "sees" the laser mark on the

object. The distance from the point to the camera is then calculated by triangulation (Satyaprakash, 2007). This method is very precise and can be used for medium and small sized objects. Cyberware, for example, sells different sizes of laser triangulation scanners.

The stereoscopic method requires two photographs of the same object taken from two known points. Since the incidence angles of the light coming from the object into the cameras are known, it is possible to calculate the distance of each point. The matching of the points in the two photographs can be done in an automatic or an assisted manner. The assisted method works very well for geometric shapes, while the automated method can handle complex, organic surfaces. The stereoscopic method does not require special hardware, but it relies on relatively expensive software, such as PhotoModeller.

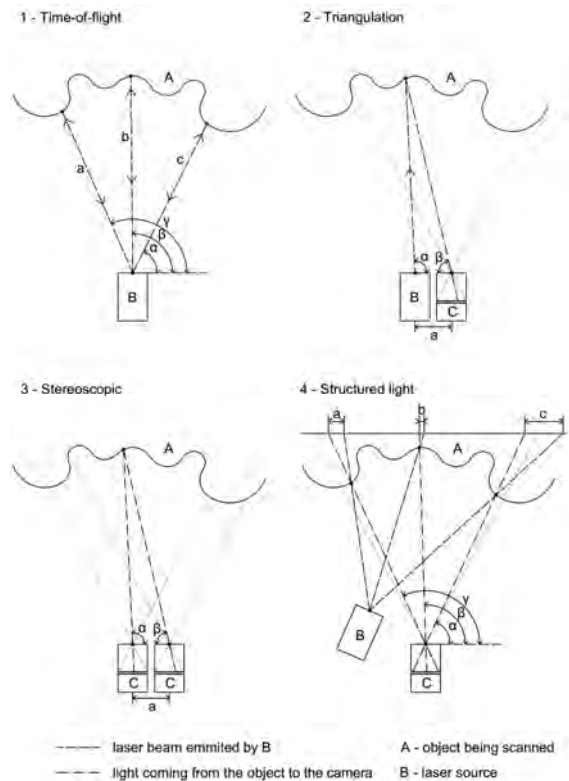

Figure. 9: The four main types of non-contact scanning methods.

In the structured light method a light pattern is projected onto the object with an LCD projector, a flashlight or a laser pointer. A video camera is used to capture the image. The distance of the object's points are calculated based on the deformation of the projected pattern. An example of this type of equipment is Spatium3D, which has been developed in Brazil.

In regards to cost, the equipment used for non-contact 3D scanning methods can be very expensive. However, there are some inexpensive alternatives that can be used in some cases. For example, for highly geometric sculptures simple photogrammetric techniques may be used. For sculptures with relatively simple free-form geometry inexpensive systems, such as David Laser Scanner, which use simply a web camera and a laser pointer, may also be tested.

4. PREPARING DATA AND DIGITALLY FABRICATING THE MODELS

After calculating the position of a number of points on the "real world" object, the 3D scanner software plots them in a vector file, which results in a "cloud of points".

According to Rowe (2008), "there is usually too much data in the point cloud collected from a scanner/digitizer, and some of it will be unwanted noise. Without further processing, the data cannot be used by downstream applications, such as CAD/CAM software or in rapid prototyping."

After the digitalization of the sculptures, the acquired data must be processed. Most 3D scanning methods produce point clouds that need to be reconstructed into 3D polygons, in order to generate a continuous surface. A reverse engineering (RE) program will need to be used for generating proper geometric models.

Physical scale models will be produced after these geometric models, with LAPAC's and Cenpra's Rapid Prototyping Laboratory's digital fabrication equipment, which includes laser cutting, 3D-printing fusion deposition modeling (FDM) and selective laser sintering (SLS). The techniques and materials will be chosen according to the geometry of each sculpture. Special types of file formats are required for each of these techniques (DXF, 3DS and STL). The files generated by the digitalization methods not necessarily will be ready for fabrication; they may require further processing such as combining front and rear digital models, correcting features, and checking widths for minimum required values. The results of that stage will be published in the near future.

5. CONCLUSIONS AND EXPECTED RESULTS

After the research about digitalization methods, it was possible to conclude that the non-contact methods will be quicker and safer for the museum sculptures. Among these, the image interpretation methods are economically more feasible, although less accurate than the non-contact direct measuring methods. Although the objective of the digitalization process is to produce small scale models of the sculptures, it is interesting to take advantage of this opportunity and effort to obtain precise digital models, because they can also be used as illustrative material in the museum's website (in VRML format). Besides, the data can be used later for producing full-scale models for other purposes in the future. Since there are so many different technologies available, and so many different types of sculptures in the museum, it will only be possible to determine the exact most appropriate method for each of the, after the practical work begins.

The main result of the present project will be the production of 1:25 scale models of 100 sculptures from the architectural model of the museum. The model is expected to help in the planning of new exhibitions. Another result will be the development of a methodology for producing scale models of sculptures, with suggestions of techniques that should be used for different types of sculptures. We expect that the description of this methodology will help in the production of scale models for other museums.

6. REFERENCES

- Editorial. 2008. 3D scanning technologies. Available at <http://www.3dscanningtechnologies.com/> (accessed 15 June 2008)
- Gambino, M. et al., 2003. A 3D Scanning Device for Architectural Reliefs Based on Time-Of-Flight Technology. In: Springer Proceedings in Physics - Lasers in the conservation of artworks. Dickmann, K., Fotakis, C. and Asmus, J. F. Osnabrück, Germany.
- Hudspeth, M., 2006. MCAD Modeling Methods—3D Input Technology. Reverse-engineering tools save time and money. In: Cadalyst.
- Mitchell, W., 1990. *The logic of architecture*. The MIT Press, Cambridge.
- Rowe, J., 2008. Trends in Reverse Engineering. Affordability and greater ease of use result in more respect for the reverse-engineering market. In: Cadalyst.
- Santos, J. R. L.; Brancaglioni Jr, A.; Kuroki, I. R.; and Silva, J. V. L., 2004. Tri Dimensional reconstruction in Mummies. In: Proceedings of the V World Congress on Mummy Studies. Torino, Italy.
- Satyaprakash, D., 2007. Laser Scanners in Terrestrial Surveying. The Global Geospatial Magazine.

7. ACKNOWLEDGEMENTS

The authors are indebted to FAPESP, CAPES and CNPq for providing funds for the laboratories and scholarships for the students participating in the research.

A HISTORICAL LANDSCAPE AT THE CROSSROADS OF CULTURES: A DIGITAL LANDSCAPE AT THE CROSSROADS OF COMPUTER-AIDED RECONSTRUCTIONS AND GIS APPROACHES

E. Jerem^a, J. Laszlovszky^b, P. Szabó^c, Zs. Vasáros^d, Zs. Végvári^e

^a Archaeological Institute of the Hungarian Academy of Sciences, jerem@archeo.mta.hu

^b Central European University, Department of Medieval Studies, laszlovj@ceu.hu

^c Institute of Botany of the Czech Academy of Sciences, szabo@policy.hu

^d Research Institute for Visualization, Architecture and Archaeology, rivaa@t-online.hu

^e Tondo SP1 Ltd. Complex Engineering Services, vegvari@tondo.hu

KEY WORDS: 3D architectural and landscape models, environmental and landscape archaeology, authenticity of computer-aided reconstructions, GIS, changes in water level

ABSTRACT:

This paper focuses on the visualization and demonstration of different attempts to reconstruct water levels and their relationship to relevant datasets. It is based on the pilot project of a long-term environmental historical research scheme for the Danube Bend, an area on the tentative list of the UNESCO World Heritage sites. We aim at reconstructing both built heritage and the surrounding environment, with special emphasis on changes in the water level of the Danube. Dynamic environmental models play an important role in the analysis and visual processing of the data and the crucial question of authenticity of reconstructions is also addressed.

1. INTRODUCTION

Technical development in the field of computer-aided reconstruction has significantly contributed to the creation of new research approaches in the field of environmental-historical studies. 3D reconstructions and virtual reality programs have become very popular for archaeological sites and for partially destroyed historical monuments. The attractive visual effects of these programs have increased their popularity and the application of similar software contributed to the development of landscape studies. Early attempts in this field emphasized the advantages of such applications in the context of flexibility compared to the inflexibility of reconstructions built in stone or brick. However, for the creators of such programs visual effects and technical developments have become more attractive than theoretical issues of academic research. If archaeologists want to use the flexible character of these reconstructions, the most important problem, the question of authenticity, should be investigated (Laszlovszky 2008; Pescarin 2008).

2. RESEARCH AREA AND RESEARCH PROBLEMS

The topic of our paper is based on the pilot project of a long-term environmental-historical research scheme focusing on the Danube Bend, a region on the tentative list of UNESCO World Heritage sites (Laszlovszky 2006) (Figure 01). It is also an area with important archaeological information on the cross-cultural nature of a landscape characterized by an intricate system of natural and cultural heritage features (Laszlovszky 1995). The long-term environmental historical changes of major European rivers are in the front line of interdisciplinary research using archaeological, ecological, historical and pictorial sources and data (Schmid & Haidvogel 2008), which makes the Danube Bend an especially important case study. Fundamental

environmental changes can be detected over the last ten thousand years in the Danube valley, dominated by changes in this river that connects Western and Southeastern Europe. This river was and remained the main trade route and axis for cultural interactions. Significant historical water level changes influenced the size, position and structure of settlements along the river, the changing location of river crossings – influenced also by the transformations of the riverbed and the water level – also played a crucial role in the dynamic re-organization of settlement systems. Reconstructions of this landscape are based on larger datasets derived from intensive field survey projects (connected to the construction of a major hydro-electric power station), archaeological excavations and stratigraphic sequences, as well as on the analysis of written evidence (charters, chronicles, travellers' accounts, etc.) (Szabó 2005, 93–118). A large number of etchings and other visual images from the Early Modern Period and cartographic sources from the late eighteenth century onward are also used for reconstructing the transformation processes of this landscape, as well as for creating the images of everyday life included in the reconstructions.

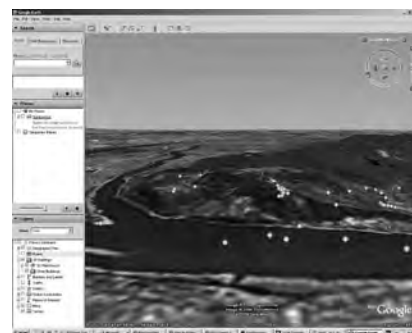

Figure 1: The Danube Bend and Visegrád from the NE (screenshot). Google Earth, modified by Zsófia Végvári.

The planned long-term research project aims to deal with a crucial area of the Danube, the part of the river between the towns of Esztergom (a Roman site, capital of Hungary for more than two centuries in the Middle Ages) and Budapest (with Aquincum, the Roman capital of Pannonia province, and Buda, the capital of Hungary in the Late Middle Ages). Emphasis will be given to the historical-environmental changes of the last three thousand years, including important periods of short-term environmental processes. Very significant, sometimes dramatic changes can be observed by comparing the last millennium BC, including the emergence of a new Roman *limes* road system along the river in the first and second centuries AD, and its continued use during the Middle Ages (particularly in the twelfth-sixteenth centuries). Major environmental changes will be demonstrated in a set of virtual reality images and 3D landscape reconstructions of the Danube Bend. These reconstructions will also include the architectural complex of the medieval royal palace at Visegrád. These images show not only the built heritage of this area and its archaeological features, but also architectural reconstructions, contemporary daily life, historical events (sieges of the castles, royal meetings, etc.) and the people of the various periods. The Danube is the most important element of these images, connecting the different historical periods to each other. The changing archaeological features and the sites on the riverbank also illustrate the main historical transformation processes of the region. At the same time, the environment and the river itself changed as a result of major environmental and landscape changes. In the Iron Age and the Celtic Period, large, horizontal settlements were the most characteristic types of human habitations, located at the mouths of tributary rivers or at crossings of the Danube. Later (from La Tène C2, i.e., from the second century BC onwards) the combination of fortified hilltop sites (Esztergom, Gellérthegey, etc.), and horizontal settlements around them were more characteristic. Very characteristic transformation processes occurred in the settlement system during the Roman Period. The creation of the *limes (ripa)* resulted in the construction of a complex system of defence buildings (watch-towers, fortifications, military camps) and led to the emergence of new settlement sites and urban centres. At the same time, some of the settlements of the local Celtic populations were incorporated into the Roman settlement system. These major spatial reorganizations of human habitation areas were also influenced by environmental processes, amongst them by significant water-level changes in the Roman Period. Paleo-environmental data (dendrochronological data, archaeological stratigraphy combined with natural scientific research results, etc.) suggest that this period was much drier and warmer than the following centuries. Therefore, the impact of the abandoned Roman fortifications on the medieval period is not only a historical problem of continuity or re-use, but also a question for the reconstruction of the riverbed, or for the water-level changes (Grynaeus 2003). Preliminary investigations indicate that after the Roman Period, particularly in the fourteenth to sixteenth centuries, significant changes occurred in the hydrological system of the area. Thus, the Roman military complexes, built close to the river in a relatively dry period, were partially destroyed by the later higher water levels and flood events. Therefore, some of them are partly covered by the river itself, and only underwater archaeological investigations can reveal their features and structure. Later – medieval – monuments are further away from the river bed, but many of them from the thirteenth to the fifteenth centuries were also temporarily covered by more recent major floods. The fluctuation of the water level and the sequence of dry and wet periods, therefore, can be demonstrated by the topographical situation of settlements and archaeological sites.

3. PILOT PROJECT: HISTORICAL WATER-LEVEL CHANGES AND THEIR IMPACT ON THE MEDIEVAL PALACE COMPLEX AT VISEGRÁD

In this short paper, we only focus on the very significant historical water-level changes of the Danube at Visegrád, a major archaeological complex in the Danube Bend. Visegrád was the capital of Hungary in the fourteenth century and a secondary royal residence in the fifteenth and early sixteenth centuries (Buzás-Laszlovszky-Magyar 2003). Recent archaeological and historical-environmental studies have confirmed the earlier hypothesis that during the last two centuries of its existence this royal centre and palace complex was seriously affected by the water-level changes of the river and by possibly devastating major floods. The palace complex was mainly destroyed during the Ottoman-Turkish occupation in the sixteenth and seventeenth centuries, and the remains of the late medieval buildings have been excavated since the 1930s. Using computer-aided architectural reconstruction we have been able to reconstruct even those parts of the complex which were not rebuilt during the restoration campaigns of the last century. These reconstructions were prepared on the basis of recent archaeological-topographical investigations in the centre of the modern urban settlement (Mészáros 2007) and on a very detailed architectural analysis of the palace complex (Figures 02-11). Furthermore, virtual reconstructions were created using the data of the environmental-archaeological research and excavation of the medieval royal garden, attached to the palace buildings (Pálóczi Horváth – Torma 1999). All these data are now integrated into GIS, incorporating archaeological, architectural and historical-environmental datasets. Meanwhile, the new 3D and virtual reconstructions influence our research methodology for carrying out archaeological excavations at certain points and areas of the Visegrád region to answer problematic questions related to the reconstruction process itself.

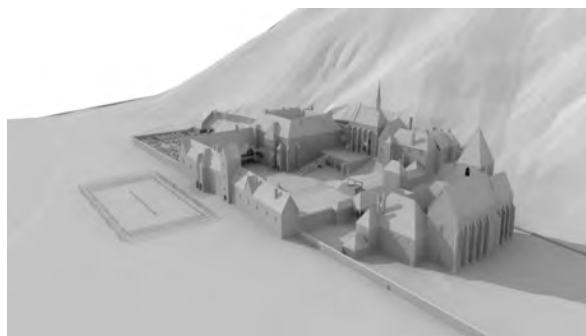

Figure 2: A shaded 3D model of the royal palace based on on-site surveys and GIS data. The original 3D model was prepared by Gergely Buzás and Zsolt Vasáros. Software: ARCHiline, 3Dmax

4. DATA ACQUISITION AND DATA CAPTURE

Virtual landscape reconstructions and dynamic environmental models play a crucial role in the analysis and visual processing of the data. Such reconstructions are based on larger datasets derived from intensive archaeological excavation projects connected to the research and restoration of the palace complex, archaeological excavations and stratigraphic sequences from different parts of the modern settlement, as well

as from the analysis of written and cartographic evidence. The results are summarized in a sequence of maps, each representing an important historical period, as well as in 3D reconstructions of the area including dynamic elements. The dynamic character of the program is designed to show the different levels of datasets used by the reconstruction process and to highlight the different levels of accuracy.

Part of the project is the creation of virtual models of medieval buildings and their architectural details in Visegrád and the surrounding area, looking at the building complex in its setting (Figures 05-11). For this, we use various technologies, such as a 3D scanner, a large-format landscape scanner, and 3D printer. We also digitize and recreate ground plans and other drawings with 3D software. Topometrical high-definition 3D surface scanners, optimized for the requirements of arts and cultural heritage, allow for the 3-dimensional digitization of art objects and paintings with very high resolution and accuracy, typically in the μm -range for the depth and up to 2,400 dpi (about $10\ \mu\text{m}$) for the spatial resolution. Moreover, the texture and/or color of the objects can be recorded, offering a one-to-one correspondence of 3D coordinates and color information (Breuckmann and al.1997; Rinaudo et al. 2007).

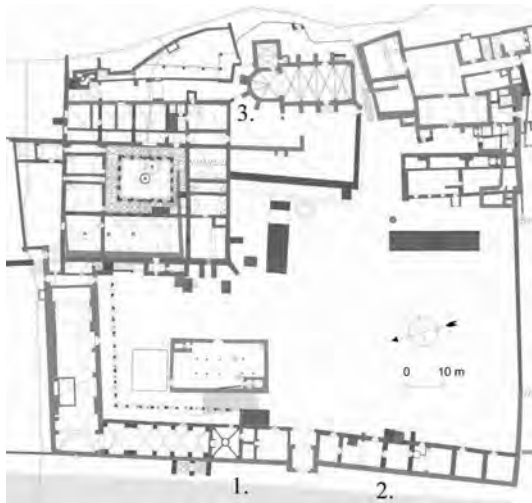

Figure 3: Updated ground plan of the royal palace: different colours indicate different periods. Software: AUTOCAD, ARCHiline

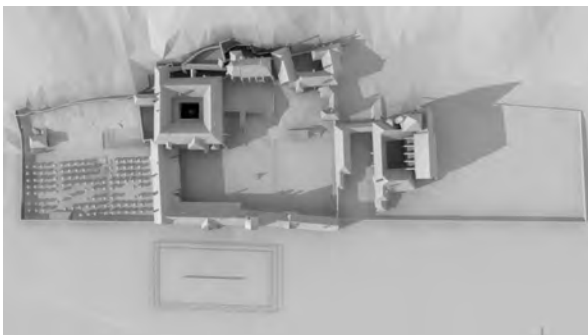

Figure 4: 3D rendered file of the ground plan of the royal palace. This model represents the elements of a building phase on Fig. 3. in blue. Software: ARCHiline, 3Dmax

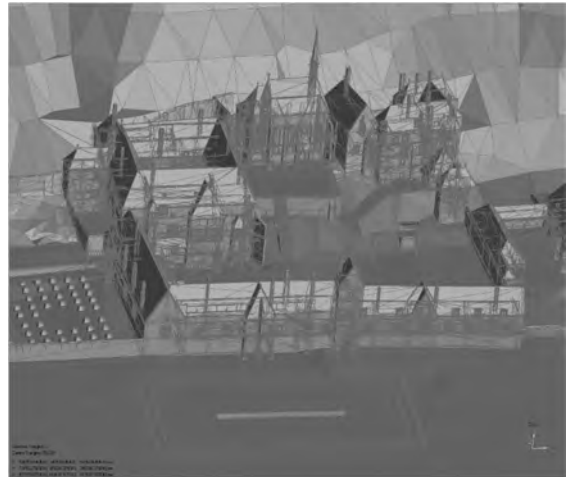

Figure 5: Object color + edges of the 3D model (Geomagic)



Figure 6: Geomagic screenshot from the 3D model: Colour representation of triangles from the surface web.

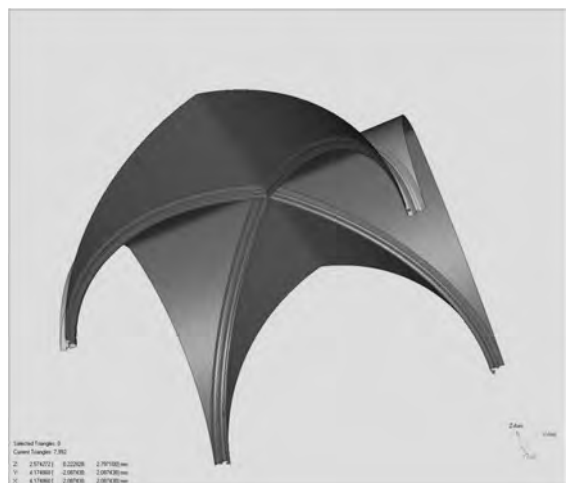

Figure 7: Vaulting prepared based on survey. Software: 3DMAX, edited by Geomagic Studio



Figure 8: Built 3D model, views over the interior. The windows were redrawn based on scanned 3D data (window fragments).



Figure 11: Quick rendering of the model. Left: stairs. On the mezzanine carved window. Right, in the back: probably an entrance to the pantry or small storage room for wood (most logical solution, since the stove is on the other side of the wall). Texture can be replaced, possibly simple stone or painted plaster. Scanned data: doorframes. The original file (500MB) has been reduced. Software: Archicad.

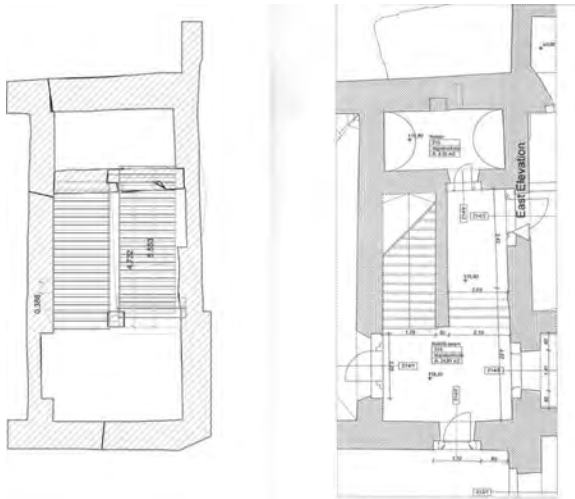

Figure 9: Left: The digitized ground plan of the entrance hall. Compared to many 3D models, the walls were drawn based on individual ground plans and wall thicknesses. Work-phase ground plan (Archicad). Right: survey drawing with windows and doors, stairs and vaulting.

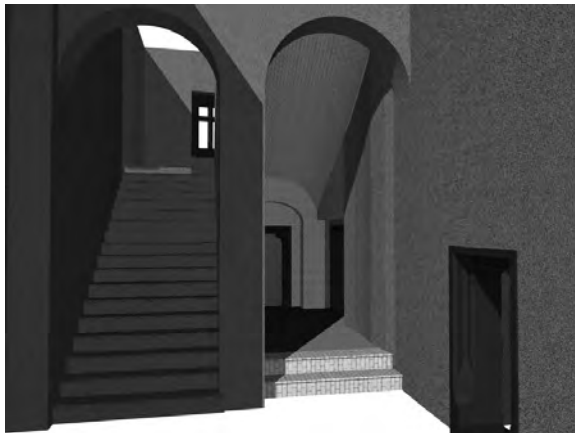

Figure 10: Raw 3D model with artificial textures, without ceiling and floor. Unshaded. (Archicad)

State of the art systems are equipped with 5 MPixel cameras, offering spatial resolutions for small FOVs down to 10 μ m (according to 2,400 dpi for flat surfaces) and depth resolutions of a few μ m. Due to the high flexibility and mobility of these systems, they are suitable for many different applications. To overcome two of the most severe limitations of optical triangulation systems, special system configurations and recording techniques are used in the stereoSCAN-3D and smartSCAN-3D systems of Breuckmann. First, they are based on a unique asymmetrical 2-camera setup. With this setup one can realize three triangulation angles in one sensor configuration.

5. DISCUSSION OF RESULTS AND METHODOLOGICAL ISSUES

By using the 3D models we are able to investigate the impact of water-level changes and to study the possible destruction caused by long-term processes or temporary dramatic water-level changes (floods) in the zone of the palace complex. The changing water level was studied in 25 cm layers, thus different parts of the complex (royal gardens, cellars of the main palace building, ceremonial courtyard, royal apartments, etc.) were seen in different water-level situations (Figure 12). By using this technique we were able to compare data derived from this reconstruction with stratigraphic datasets from archaeological excavations. Layers indicating temporary water coverage, cellars filled in after major flood-events, sunken floor-levels, and collapsed Gothic vaults were used as indicators for fast and dramatic water-level changes and the destruction they caused. By comparing the spatial distribution of these features with the 3D reconstruction of flood events, we were able to quantify the devastating effects of these events. This dataset for medieval flood-events was compared to the large scale settlement structure information pattern offered by the study of historical maps from the eighteenth century onwards and by the spatial analysis of houses built in Visegrád in this period. These pieces of information were also compared to the flood-level changes recorded in written documents and on flood-marks during the last two centuries. Further research questions can also be solved by the computer-aided investigations of dramatic flood events

during the last decade (see our poster on the same topic). Aerial photographs taken during the highest water-level periods of these floods, and the study of the extension of water-covered areas offer us another set of control data to reconstruct the impact of historical floods. Using 3D terrain models and combining them with stratigraphic information based on archaeological excavations, we are able to reconstruct different settlement areas in different periods. These models can also indicate to what extent these settlement parts were endangered by contemporary dramatic flood events, or by slow long-term water-level changes. Thus, the spatial reorganisation of the palace complex, the abandonment of certain habitation levels, as well as the topographic structure of the early modern settlement (Laszlovszky 2004) can be used as indicators for historical-environmental changes, and the sequence of events during such changes can be analysed and visualised with the help of digital models, 3D reconstructions combined with datasets in GIS.

A very powerful visual demonstration of this research is an animation based on a 3D model of the palace complex and on the different levels of the water changes. However, the visualization of such flood events or other environmental changes such as the transformation of the woodland coverage of the area (Szabó 2005) or the extension of habitation areas surrounding the palace complex, can create major problems for the authenticity questions related to these reconstructions.

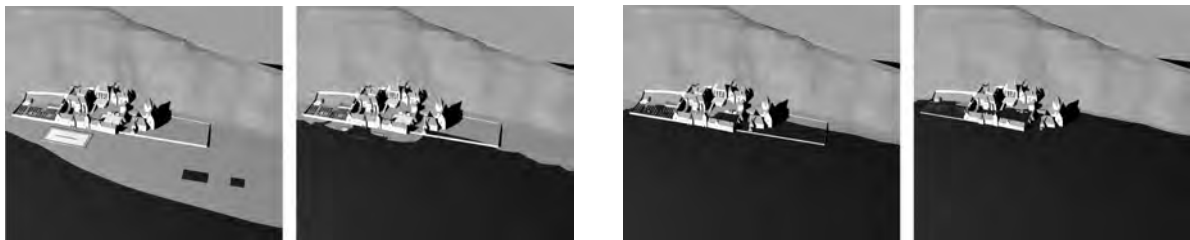

Figure 12: Simulation of changes on the riverbank of the Danube: water-level raised by 0.5m, 1.25m, 3.25m and 6m
Software: Rhinoceros

We have proposed two solutions for the authenticity issue. One of them is the “zoom-in zoom-out” option used on large-scale landscape reconstructions. In this case, the total image of an area (like an aerial photograph) can be seen from above, and one can “fly above” it, as in any similar commercial program. However, by “flying closer”, or by “zooming in”, the resolution of individual features of the landscape (buildings, elements of the ancient flora, etc.) is connected to the accuracy of information we were able to collect and analyse for that particular area. Another solution for the accuracy issue is when “hyper-image” elements are incorporated into the large-scale reconstruction images. In such cases, as are used for example in *interior* reconstructions, the viewer can “click on” individual elements of the image, and thus open further screens with the relevant archaeological information or with a discussion of different reconstructions attempts. For the landscape images, this academic background is a connected GIS, itself offering further analytical approaches for large datasets. By the combination of these techniques, landscape and environmental reconstructions can be seen more as powerful research tools than simply fascinating visual representations of the past.

As the results will be summarized in a sequence of maps, each representing an important historical period as well as in 3D reconstructions of the area including dynamic elements, these visual representations cast a “shadow” on the reconstruction process itself. Datasets, problems of archaeological interpretations are “covered” and to some extent disguised by the visual elements of the computer presentation. The opportunity to follow the research results and the research process step-by-step is usually not available for the viewer of these programs. The dynamic character of the program to be used for the Danube Band, therefore, should also offer a solution for these problems. We are experimenting with visual and programming elements already used in architectural reconstructions, but so far not applied in landscape reconstructions. We combine them with effects familiar from image processing programs. The new program is designed to show the different levels of datasets used by the reconstruction process and to highlight the different levels of accuracy. The problem of authenticity is addressed in all levels of the reconstruction. The pilot project also aims at the creation of new visual tools to “move” between the different layers of academic datasets and reconstruction strategies. The software can be seen as an important tool in educational programs for very different groups of society and at the same time as a powerful, dynamic research tool for many aspects and methods of academic research.

6. CONCLUDING REMARKS AND FUTURE ACTIVITIES

The project described above is in its initial phase. Different parts of the relevant datasets represent very different research levels in quality and quantity. At the same time, they were acquired from very different sources and their applicability also raises different problems. Therefore, the final construction of the relevant GIS and the 3D reconstructions will require years of work. The incorporation of landscape archaeological and landscape historical elements and datasets into the 3D models and their usage in the visual landscape reconstructions will contribute to the accuracy and authenticity of the historical image presented. In this way, the gap between the academic research and the visual presentations of the same problems for the wider public can be bridged with the help of a program element, showing visitors to the virtual tours the parts “behind the scenes”. Modern archaeological and art exhibition strategies have successfully used this element to highlight the role of academic research in the reconstruction of the past, and at the same time to indicate the limits of our approaches (Carillo et al. 2007). This research and visualisation attitude can be used for all elements of the reconstruction, including architectural, landscape and environmental historical aspects of the project. This is a major challenge for academic work, as Visegrád also offers many visitors a major re-enactment program every year

in the form of the “palace games”. This very popular program does not present itself as a direct result of academic research, but with the help of attractive digital programs, visitors interested in the spectacular elements of the program can also enjoy a more historical interpretation of the same sites and events in the form of digital animations and complex interactive computer programs. This popular demand also helps us to redefine our work and the authenticity of such approaches in the emerging new digital-virtual world.

7. REFERENCES

- Breuckmann, B., Bereczky, L., Végvári, Zs., 1997. High definition 3-dimensional scanning and printing technologies in arts and cultural heritage, *Archaeology and Palaeontology, EVA 2007 Berlin*, pp. 95-100.
- Buzás, G., Laszlovszky, J., Magyar, K., 2003. Medieval Royal Centres. In: *Hungarian Archaeology at the Turn of the Millennium*. Visy, Zs., (ed.), Nemzeti Kulturális Örökség Minisztériuma, Budapest, pp. 348-364.
- Carillo, E., Rodriguez-Echavarría, K., Arnold, D., 2007. Displaying Intangible Heritage Using ITC. Roman Everyday Life on the Frontier: Vindolanda. In: *VAST2007 – Future Technologies to Empower Heritage Professionals*. Arnold, D., Chalmers, A., Niccolucci, F., (eds.), Brighton, pp. 51-55.
- Grynaeus, A., 2003. Dendrochronology and Environmental History. In: *People and Nature in Historical Perspective*. Laszlovszky, J., Szabó, P. (eds.), Budapest, CEU Medievalia 5, pp. 175-192.
- Laszlovszky, J., (ed.), 1995. *Medieval Visegrád*. Budapest, ELTE.
- Laszlovszky, J., 2004. Királyi palota, ferences kolostor és városi település (Gondolatok a későközépkori Visegrád településfejlődéséről). (Royal palace, Franciscan Friary and Urban Settlement. Ideas on the Late Medieval Settlement Development of Visegrád) In: „*Es tu scholaris*” *Ünnepi tanulmányok Kubinyi András 75. születésnapjára* (“*Es tu scholaris*”. *Studies in Honour of András Kubinyi on his Seventy-fifth Birthday*”) Romhányi, B. F., Grynaeus, A., Magyar, K., Végh, A., (eds.), *Monumenta Historica Budapestinensia XIII*. Budapesti Történeti Múzeum, Budapest, pp. 61-71.
- Laszlovszky, J., 2006. The Medieval Royal Seat and Forest at Visegrád. A Proposed World Heritage Site and its Heritage Aspects. In: *Archaeological and Cultural Heritage Preservation within the Light of New Technologies*. Jerem, E., Mester, Zs., Benczes, R., (eds.), Budapest, pp. 83-89.
- Laszlovszky, J., 2008. Authenticity, computer aided reconstructions and virtual reality. Abstract In: *CAA2008. On the Road to Reconstructing the Past*. Jerem, E., Redő, F., Szeverényi, V., (eds.), Budapest, p.338.
- Mészáros, O., 2007. Kirchenforschungen 1976 bis 2003 in Visegrád, Széchenyi strasse 4-10. *Folia Archaeologica* 53, pp. 203-224.
- Pálóczi Horváth, A., Torma, A., 1999. Environmental archaeological research at Visegrád in the medieval garden of the Royal Palace. In: *Archaeology of the Bronze and Iron Age*. Jerem, E., Poroszlai, I., (eds.), Budapest, pp. 343-350.
- Pescarin, S., 2008. Reconstructing archaeological landscape: interpretation, documentation and virtual reality. In: *CAA2008. On the Road to Reconstructing the Past*. Jerem, E., Redő, F., Szeverényi, V., (eds.), Budapest, pp.328-329.
- Rinaudo, F., Bornaz, L., Ardissonne, P., 2007. High accuracy survey and modelling for Cultural Heritage documentation and restoration. In: *VAST2007 – Future Technologies to Empower Heritage Professionals*. Arnold, D., Chalmers, A., Niccolucci, F., (eds.), Brighton, pp.19-23.
- Schmid, M., Haidvogel, G., 2008. Coupling the long-term dynamics of natural and social systems: Towards an environmental history of the Danube. In: *Human Nature: Studies in Historical Ecology and Environmental History*. Szabó, P., Hédl, R., (eds.), Brno, Botanical Institute of the CAS. pp. 64–73.
- Szabó, P., 2005. *Woodland and Forests in Medieval Hungary*. BAR International Series 1348. Archaeolingua Central European Series 2, Oxford.

Virtual Reality Applications in Cultural Heritage

THE AUGMENTED DIGITAL RECONSTRUCTION OF A XVII CENTURY CONVENT IN BRAZIL

Alberto Raposo, Silvia Ilg Byington

Pontifical Catholic University of Rio de Janeiro (PUC-Rio), Computer Graphics Technology Group
R. M. de S. Vicente, 225, Rio de Janeiro, RJ, Brazil, 22453-900
araposo@tegraf.puc-rio.br, ilg@centroin.com.br

KEYWORDS: Digital Reconstruction, Augmented Reality, Virtual Reality, e-Museum, e-Exhibition

ABSTRACT:

This paper describes the digital reconstruction of the Convent of São Boaventura, whose construction started in 1660 at the state of Rio de Janeiro, Brazil, and is currently in ruins. The digital reconstruction process is an interplay between extensive historic research and computer graphics technology, serving as a divulgation means of the cultural patrimony of a region with large environmental and socio-economical degradation. The ruins of the current historical site refer to the partial reform realized between 1784 and 1788. The digital reconstruction aims to project and model what should have been the architectonic complex if the construction were concluded. Hypothetic plants elaborated by researchers, as well as original fragments were used as input for the digital reconstruction. A few material and documental registers enabled the virtual reproduction of some original ornamental elements. Additionally, going beyond the available registers, the historically plausible model is being completed using architectonic and ornamental objects of the same style and epoch, whose origins are specified. From the technological point-of-view, the virtual model is a challenge in the sense that it is the stating point for several exhibition possibilities, ranging from interactive navigation to augmented reality. In both cases, the photorealistic real time rendering of such a rich model is a major challenge. In the case of augmented reality, which is the projection of the virtual model over the real one, the challenges are even greater, including markerless tracking, modelling of the real lightning conditions, among others. This paper discusses the ongoing efforts towards the virtual reconstruction of the convent and the related computer graphics challenges.

1. INTRODUCTION

The digital reconstruction of the Convent of São Boaventura and the village where it was located (Vila de Santo Antônio de Sá) is part of a series of cultural and educative multimedia products developed by the Information Center of COMPERJ (Petrochemical Complex of Rio de Janeiro) / Petrobras in partnership with Tecgraf / PUC-Rio. The ruins of the convent (Figure 1) are located in the eastern part of the state of Rio de Janeiro, Brazil, a region with large environmental and socio-economical degradation, currently starting its revitalization with the implantation of a strategic petrochemical industrial park.

The digital reconstruction is part of a project called Patrimonial Education for the East of Rio de Janeiro, aiming the valorization and preservation of the archeological, historic, cultural and environmental patrimony of the region. The project envisions the possibility of connection between the past and the future of local communities by means of educational actions that, at one side construct and recover the cultural patrimony of the region, and at the other side qualify the citizens for the near future.

The difficulty for a plausible reconstruction of the convent is that there are few available material and documental registers. The project also acquires technological challenges because the convent is located in the entrance of the future industrial park, and it will be part of a large complex for public visitation, which must integrate the high technology related to the industrial park with the historic place where it is located.



Figure 1: Ruins of São Boaventura Convent, before the propping process.

This paper presents the ongoing work on the digital reconstruction of the convent (Figure 2) and the technological challenges in the fields of augmented and virtual reality that will be an important part of the visitation center. It is organized as follows. In the next section, we briefly describe some aspects of the archeological site of Vila de Santo Antônio de Sá. In Section 3, we discuss the reconstruction process, and in Section 4 we present some technological challenges for several exhibition possibilities. Conclusions are presented in the last section.



Figure 2: Virtual model of the convent.

2. THE ARCHEOLOGICAL SITE

The area where the industrial park will be located occupies a singular place in the history of the occupation and the economical and cultural development of the state of Rio de Janeiro. In that region, there are archeological vestiges of successive occupations by distinct ethnical groups that reveal the richness and the historic complexity of the environment and culture of the region. Its prosperity and political, economical and cultural importance in the XVII and XVIII Centuries derive from extractive activities, agriculture, and the population flow through the interior of the state. The population increase and the existence of a large number of indigenous tribes attracted religious orders, such as the Jesuits and the Franciscans, which were colonization agents dedicated to the Christian preaching and the catechization of indigenous populations throughout the country.

The Franciscans built the Convent of São Boaventura between 1660 and 1670, synthesizing the religious architecture of a period known as Brazilian Baroque. In 1697 the Vila of Santo Antônio de Sá is established. The convent went through a partial reform between 1784 and 1788, period when the Rococo style prevailed.

In the middle of the XIX Century, the economic decadence and successive epidemic diseases caused the definitive abandon of the village and its surround rural areas. This decadence persisted until recently, laying the region aside the development process of the country in the last century.

The archeological site of the village, including the ruins of the convent, is under governmental trust since 1980. The challenge of this work is to virtually reconstruct, using computer graphics and virtual reality, the village and the convent. At the moment, only the convent has been reconstructed, being therefore the focus of this paper.

3. THE DIGITAL RECONSTRUCTION PROCESS

The ruins of the convent that characterize the archeological site refer to the unfinished reform realized by the monks and their slaves between 1784 and 1788. Therefore, the virtual reconstruction has the goal of not only recreating in computer graphics what has been destroyed by centuries of abandon, but also to project and build what would have been the convent if the reform were concluded.

In the virtual reconstruction process we faced a typical challenge of virtual heritage, which is the tension between authenticity and completeness (Devine, 2007). This arises from the fact of having incomplete historical record. According to the same author: "If a reconstruction is limited to only that which is known to be true then much will be omitted. If hypothesized data is used to fill out the model then, no matter how plausible, issues of historical authenticity inevitably arise".

Since the archeological studies in the area started recently, no conclusive results have been published yet. For this reason, up to this moment, the virtual reconstruction has been based on historic sources, specific bibliography, and partial analysis of material fragments found in the ruins.

Marks identified in the terrain and in the architectonic structure, together with hypothetical plans designed by researchers in the decades of 1930 and 1990 guided the definition of the floor plans and the modeling of the buildings. Original fragments found in the ruins, such as floor, wall, bay and roof revetments, constituted the basis of the textures. Similarities with the spatial distribution of contemporary convents of the same religious order and architectonic style helped the reconstruction of specific places such as the seclusion ambient.

A few material and documental registers enabled the virtual reproduction of diverse ambiances and some original ornamental elements. For example, the main chapel was modelled using reports of travellers that were there in the XVIII Century (Figure 3). The bells and the images of the conventual chapel were modelled based on the original ones identified in the historic sources, which were localized in churches of the proximities. The same happened with the recreation of the wall tiles of the conventual seclusion, whose fragments were stored in another convent in the city of Rio de Janeiro.

Additionally, going beyond the available registers and material fragments, the historically plausible model is being completed using architectonic and ornamental objects of the same style and epoch, whose origins are specified. Since the digital reconstruction is guided by the reform of 1788, period of Rococo, the carving of the altarpiece and additional ornaments follow this style.

The model of the virtual convent was built using the 3ds Max, and then exported for the appropriate visualization in virtual or augmented reality.



Figure 3: Reconstructed main chapel.

4. THE AUGMENTED RECONSTRUCTION – EXHIBITION AND INTERACTION CHALLENGES

Once the extensive historic research gave us enough material for the computer graphics modeling of a historically plausible virtual model, the next step is the definition of the use of this model for exhibition purposes, according to the project of patrimonial education and to the high technology demands of the visitors’ center of the industrial park.

According to (Zara, 2004), cultural heritage techniques can be classified by the nature of the examined objects and the methods used for their visualization. This author classifies presentations in four categories: image, movie, model and scene. The first two categories explore the real scenario, while the last two explore virtual objects. The difference between model and scene categories is that the first one is related to the examination of single objects, while the second is the navigation in 3D scenes consisted of many objects

Although the focus of our work is on the virtual convent, we may say that we want to cover almost all of the four categories described above, using concepts of mixed reality, integrating real and virtual visual information.

The mixed reality continuum was defined by (Milgram and Kishino, 1994) as a spectrum having the real world at one extreme and the virtual reality at the other (Figure 4). Along this spectrum, there are also the Augmented Reality (AR) and the Augmented Virtuality (AV). AR is based on the real world enhanced by virtual information, while AV is based on the virtual world enhanced by information of the real world.

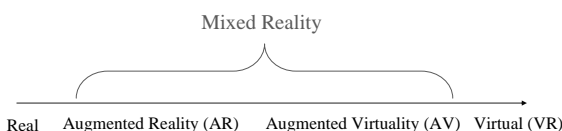

Figure 4: Mixed Reality Continuum

For exposition purposes, we are going to focus on AR applications, making good use of the fact that the real convent are located next to the visitors’ center building. Therefore, we started to develop some preliminary AR applications, described in the following subsections.

4.1 Panoramic AR

The first application we developed makes use of panoramic images of the ruins, integrated with the virtual model and the terrain map. The idea is to have a global vision of the archaeological site and see the 360° image of the convent from several predefined points on the site. While seeing the panoramic images, the users may also superimpose the virtual model with a variable transparency level, to compare the current ruins with the original building (Figure 5).



Figure 5: Panoramic AR application.

This application uses only the external parts of the convent model, since the panoramic images are based on points of view outside the building. The yellow point in the first image of Figure 5 shows the point of view for the panoramic images shown in the second and third images (there are other points of view available). The second image shows the image with a preliminary virtual model superimposed, and the third image shows the real photography.

For exposition purposes, this application may be viewed in two interactive 180° displays, such as illustrated in Figure 6. The idea is that multiple users obtain additional information about the convent, the region, and the ecosystem by touching different parts of the screen.

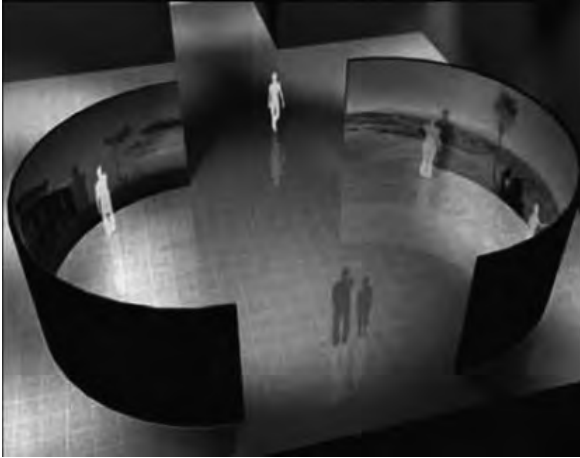

Figure 6: Interactive curved display for the panoramic AR application.

4.2 VR Navigation Application

The second application uses only the virtual model, and is a typical scene navigation application, where the users may walk through the reconstructed convent.

However, once this model is aimed at the valorization of the patrimony and cultural heritage, more than simply a virtual space, it was necessary to build a virtual place. Here we are using the definition of (Harrison and Dourish, 1996): “space is the opportunity; place is the understood reality”, or, “a place is a space with meaning”. The recreation of places, and not just spaces is one of the challenges for virtual heritage (Devine, 2007).

In order to transform the model into a place, we created a navigation application with an introductory video explaining the historical context and the objectives of the reconstruction, following a videogame-like approach. Moreover, during the navigation the users may access textual information about the area they are visiting or the objects they are facing. Figures 2 and 3 are screenshots of this application.

The two applications presented above, although relevant for the project, do not represent difficult computer graphics challenges, since we used current available technologies. The following two applications represent more sophisticated challenges in terms of research in computer graphics and VR.

4.3 3D Photo Album

The third application is called 3D Photo Album, a navigation application where the users navigate through the model and move to positions from where a set of pre-calibrated pictures were taken. This application is inspired by Microsoft's Photosynth (Microsoft Live Labs, 2008) originated by Noah Snavely's work (Snavely et al., 2006).

Photosynth's input is a dense set of pictures of an object with overlapping regions. It retrieves clouds of three-dimensional points and camera models of these pictures based only on the matching features among them. Even though this technique is successful, it imposes an operational condition that is not desired in our application: it assumes the availability of a dense set of pictures with overlapping regions, and it requires a long

processing time. We assume the model's geometry to be known, implying a substantial difference in relation to Photosynth purposes, as well as allows a simplification of the camera reconstruction process.

We match models and images of buildings using a set of integrated techniques, with camera reconstruction as the main strategy. To perform such reconstruction and successfully match and catalogue the pictures, first we needed to solve the problem of identifying correspondences between elements of the image and the model, which is one of the fundamental problems in computer vision. The approach proposed to solve it was to use the building's model, positioning it in order to restrict the search for matching features on the image. This strategy assumes the virtual model to be manipulated by the user in such a way that the edges can serve as guidelines to locate corresponding features in the image, using a local search strategy in the neighborhood of the projection of the model's edges (Figure 7).

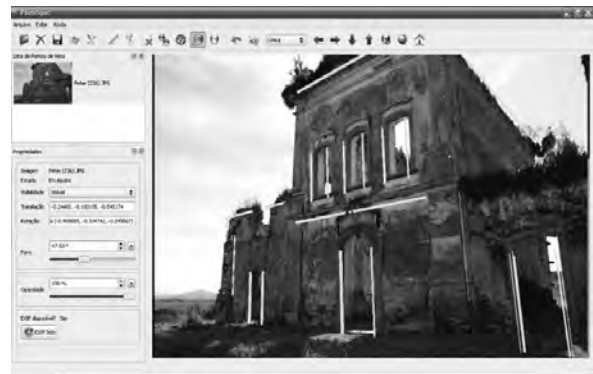

Figure 7: Model superimposed by an image with opacity of 100%. The guidelines are visible and the model can be manipulated.

The method is semi-automatic, beginning with an initial solution provided by the user which allows a local search for image-model associations rather than exploring the model's global information. If the input image contains significant noise and the photographed model has complex geometry, solving the matching problem becomes naturally difficult, and the method proposed herein becomes more dependent on user actions and prone to some degree of imprecision. In simple cases, on the other hand, the process is largely automatic and robust in relation to the model's initial position, as it is simpler to compute image-model correlations.

As final result, we have developed an application that implements the proposed method and provides a complete solution for the camera registration problem over pictures related to their virtual model. The system also provides various mechanisms to help the user compare pictures with the model, and navigate spatially over the several registered images (Figure 8).



Figure 8: A match between the model and a picture of the convent.

4.4 Markerless AR application

In an AR system, the composite of real and virtual images can be made using head mounted displays or video (Rolland et al., 1994). A challenge is to position the virtual and the real objects in the 3D scene in order to produce a coherent visualization of the mixed reality; this is a hard problem to be solved (called registration problem).

To solve the challenging registration problem, some well-defined steps have to be studied. The recovery of the user initial position relative to the real scene is known as camera (or user position) calibration. The subsequent tracking of its movements to update the camera position in the real world is the tracking phase. The virtual object to be projected onto the scene has to be modeled, and many techniques to recover geometry of real objects can be used, from CAD systems to 3D photography techniques. The final step is the visualization of the real world composite together with the virtual object; if the alignment and registration has been well solved in the previous steps there is the occlusion problem left to be solved in the visualization phase.

A characteristic that influences on the project development decision is related to the real ambient where the augmented reality system intends to be used. Indoors and outdoors environments have fundamental differences related to the possibility of controlling illumination. The possibility to positioning fiducial markers to help the calibration and tracking phases is also a characteristic of the real ambient that influences on the AR system.

There are two main distinct approaches concerning feature tracking in image or video sequences:

- Tracking based on markers
- Markerless tracking

A marker is a predefined object present in the scene that can be automatically detected by image processing. Since markers started to be used to help in solving computer vision tasks, several distinct types of markers have been proposed to facilitate the tracking task. The main characteristics of a good marker are: 1) it should be easy to detect in the scene; 2) it should be easily distinguishable from other markers present in the scene; 3) it should be robust to detect in case of partial occlusion. Another consideration is about the tracking technology – that influences on the marker design – among

them we can cite mechanical, magnetic, acoustic, inertial and optical devices.

We will focus on optical devices. When using this kind of device, an approach used to obtain information useful to calibrate the camera position is to extract special patterns from the scene that are known in real world. Here the use of markers splits the approaches into two classes: one uses synthetic markers completely defined by user, meaning that its real dimensions are also pre-defined by user (Thomas et al., 2000) and the other look for geometric characteristics naturally present on the scene that can be detected and tracked in subsequent images (Kobayashi et al., 2007; Dick et al., 2004; Vlahakis et al., 2002)

This second approach is to look for features naturally inserted into the scene of interest, that are good candidates to be used as markers. These features can be tracked in the image sequence and will be used to infer the camera position relative to the scene. These scene features can be object silhouettes based on basic line segments as well as vanishing points.

The tracking based on features of the image is the most adequate for scenarios like the convent ruins. At the moment, we are preparing a simpler application, based on the AR visualization at position-fixed semi-transparent displays, which may have their rotation tracked to produce the AR visualization directly over the convent view (Figure 9).



Figure 9: Illustration of an AR station looking at the real convent.

We are currently working on a hybrid system that tries to get the best of both marker and markerless tracking approaches. Invariant properties of retroreflexive spherical markers patterns are used to detect the markers in the object. The inclusion of these markers in known polygonal areas of the tracked objects helps the detection of intrinsic characteristics of them, providing more robustness to the tracking process. A case study using a mock-up of the convent ruins is presented in Figure 10.



Figure 10: Convent mockup with 3 collinear patterns of markers, to be used for an AR visualization.

5. CONCLUSION

This paper presented the efforts towards the digital reconstruction of the Convent of São Boaventura, Brazil, in a project aiming to valorize the cultural patrimony of the region. We discussed the historical and technical challenges of this reconstruction, which must integrate the high technology related to the industrial park to be constructed near the ruins.

Regarding the historical research, the challenge is to find a plausible balance between authenticity and completeness, since historic records are limited. Regarding computer graphics and VR/AR research, the challenges are the creation of attractive and meaningful applications that uses the state of the art in these technologies.

6. REFERENCES

- Devine, K., 2007. Place and Time: Creating Contextualized Presence for Virtual Heritage. In *13th International Conference on Virtual Systems and Multimedia*, Brisbane, Australia, pp. 65-72.
- Dick, A. R., Torr P. H. S., Cipolla, R., 2004. Modelling and Interpretation of Architecture from Several Images. *International Journal of Computer Vision*, Vol. 60, pp. 111-134.
- Harrison, S., Dourish, P., 1996. Re-Place-ing Space: The Roles of Place and Space in Collaborative Systems. In *ACM Conference on Computer Supported Cooperative Work*, Boston, USA, pp. 67-76.
- Kobayashi, T., Ishihara, H., et al., 2007. Examination of Mixed Reality System Devoted for Outdoor Contents as Artistic Presentation. In *13th International Conference on Virtual Systems and Multimedia*, Brisbane, Australia, pp. 121-132.
- Microsoft Live Labs, 2008. "Photosynth". <http://labs.live.com/photosynth/> (accessed 16 Jun. 2008).
- Milgram P., Kishino, A., 1994. Taxonomy of Mixed Reality Visual Displays. *IEICE Transactions on Information and Systems*, E77-D(12), pp. 1321-1329.

Rolland, J., Holloway R., Fuchs, H., 1994. A Comparison of Optical and Video See-Through Head-Mounted Displays. *SPIE Proceedings: Telem Manipulator and Telepresence Technologies*, Vol. 2351, pp. 293-307.

Snaveley, N., Seitz, S. M., and Szeliski, R., 2006. Photo Tourism Exploring Photo Collections in 3D. Technical Report, Microsoft at Microsoft Research, Redmond WA, USA.

Thomas, B., Close, B., Donoghue, J., Squires, J., De Bondi, P., Morris, M., Piekarski, W., 2000. ARQuake: An Outdoor/Indoor Augmented Reality First Person Application. In *4th International Symposium on Wearable Computers*, pp. 139-146.

Vlahakis, V., Ioannidis, N. et al., 2002. Archeoguide: An Augmented Reality Guide for Archaeological Sites. *IEEE Computer Graphics and Applications* 22(5), pp. 52-60.

Zara, J., 2004. Virtual Reality and Cultural Heritage on the Web. In *7th International Conference on Computer Graphics and Artificial Intelligence – 3IA*, Limoges, France, pp. 101-112.

7. ACKNOWLEDGEMENTS

This work was performed at Tecgraf/PUC-Rio, a laboratory mainly funded by PETROBRAS. The project presented here is part of the Information Center of COMPERJ (Petrochemical Complex of Rio de Janeiro), PETROBRAS. Alberto Raposo is partially funded by CNPq, process number 472769/2007-0.

IMMATERIAL AND PERVASIVE STORYTELLING

R.Trocchianesi

Politecnico di Milano, Milan, Italy, raffaella.trocchianesi@polimi.it

KEY WORDS: Metalanguages, Linguistic platform, Sound scripts, Cityvideocartoons, Chromatic and material trips

ABSTRACT:

The digital technologies are fundamental for new models of fruition of design oriented cultural heritage (at different scales: from art to architecture, from town to territory). A research about new systems of valorization designing the relation (and also the timing of fruition) between cultural goods and users starting from dynamics and structures of storytelling shaped with technologic tools of innovative digital systems. This approach develops at the new metalanguage where the "immaterial digital" elements become a linguistic platform. Case histories will be identified as best practices of valorization through the use of the technologies. The case histories will be analysed through three interpretation keys factors / paradigms: sound scripts; cityvideocartoons; chromatic and material journeys.

1. DESIGNING THE FRUITION

The need to think and plan new ways of interaction with cultural heritage (in its various meanings of material and immaterial culture) leads us to new patterns of use involving a strong component linked to the experiential factor, to memory, to the "dynamics of return", to the ability to explore and lead to different levels of knowledge of cultural goods being it an art piece it is a work of art, an architectural artefact, or a complex system such as a city or even a territory more difficult to interpret and circumscribe.

One of the specificity of design for the enhancement of cultural heritage is its capability to transfer the innovative processes of other sectors and other areas of application, such as that of digital technologies, to the cultural sector which is less appropriate to be the subject of planning in this field. However, within the competences of design there is also the ability to give shape to the contents of fruition in order to enable sharing, dissemination and knowledge. Shaping not only in terms of form material and materials but also in terms of immaterial factors using the tools of new technologies.

Designing the relation between cultural heritage and user also means managing the time variable as a key element in the journeys through "use" and "consumption" of the asset itself. Through new technologies precisely, we are able to develop the different narratives that may accompany the use of a property without physically invading it.

I find it interesting to try to use multimedia equipment to accompany the journey of the user at different levels of knowledge of the cultural heritage. This means inevitably weave the level of narrative screenplay with the design of exhibition or of the visit. In this case, the designer must achieve the terminology and dynamics which usually belong to the world of theatre, film, drama and entertainment in general. The staging of a story becomes the focus of the project and the technology that supports it becomes the indispensable exhibit "place".

For example we can think of exhibitions as if they were stories, as real plays which can be evoked through the words of P. Brook when he says that «One can choose any empty space and

decide which is a bare stage. A man crosses the spaces and another observes him: this is enough to make a start in a theatre». It seems interesting to highlight the coordination component of the project, the structure of the narrative device. In particular I want to focus on two aspects: the management of the story (mainly referring to space management) and the management of timing.

Regarding the first point I can borrow some terms from theatre and film making in order to identify definitions and create parallels with the logics of museum exhibitions.

The subject: "Subject" in the scenic representation: main element around which the story revolves; "subject" in exhibit: the theme of the exhibition and the conceptual paradigm that is the basis of content and pattern of use.

The screenplay: "screenplay" in the scenic representation: a story for pictures and description of the events related; "screenplay" in an exhibit: identification and exhibit characterization of the focal points of the sequencing of the "events" that constitute the experience of fruition, the relationship of "light and dark" of the journey;

The treatment: the "treatment" in the scenic representation: development of ideas and themes with characterization and formal connotation; the "treatment" in exhibit: graphic language and spatial layout (in the story of history is designed to establish the "what", while the speech and consequently the language with which it is expressed is called to give life to "how").

Regarding the second aspect focused on the relationship between space and time I will make reference to *débrayage* of space&time which provides:

- an early stage in history where the action takes place in a normal context (space topical);
- an intermediate stage characterized by a context of transition (paratopical space);
- a main stage where the event takes place in an area of "elsewhere" (utopian space);
- and a final phase which brings the reader-viewer-visitor in a familiar and recognizable (topical space).

It is not difficult, according to this logic, accompany the visitor in the experience of exhibition representation and action of fruition and do enter, more or less directly, in history. How to say R. Barthes: «In a story there is nothing insignificant, everything serves to something». In an opening scene in fact (as in a draft edited scientific and exhibit), there are “cores” (they do carry the story) and the “information clues” (state action... that add useful information to the representation).

In this logic, it is clear that culture digital and multimedia tools are a fundamental contribution to the project of the staging, in fact represent the “soul” as they work on the stratification of the significance of the cultural heritage multiplying the potential of fruition .

2. TOWARDS NEW METALANGUAGES

2.1 Languages and paradigms

In this "readability on several levels" not good enough more traditional languages to improve the usage, it is necessary to develop new forms of communication which make use of techniques and tools contemporaries. Is necessary also be able to entertain a user increasingly sophisticated and demanding, increasingly dedicated to move in the "liquid modernity" of "city weak and widespread" in a series of simultaneous information, increasingly actor who spectator.

The size "intangible" digital well supports these new languages that require new forms of expression multidimensional. I suggest three possible paradigms/keys reading that well represent the potential of digital project and collecting through the size sound, the multisensory animation and exploration, several case studies designed to highlight interesting mode of enjoyment of cultural heritage.

2.2 Paradigm “Sound scripts”

With "screenplays sound" I mean those projects which is a basic narrative structure or a mode of enjoyment of the cultural heritage almost entirely based on sound perception. In this case powers belonging to the sphere of direction, sound design, technologies are made in relation to generate new forms of knowledge.

In a society that prefers the organ of vision, make use of models based on the suggestion fruition hearing-sound means to go to press certain "ropes" that are closer to the "discovery" of the property almost won individually rather than its clear and explicit visual statement.

2.2.1 Audio-Walk. Errare: This is an innovative proposal that says the territory in a language borrowed from the theatricality is a “driving sound” produced by Fandango (film publishing house) in which a path uncommon in the centre of the city of Parma is driven by the narrating voice a character who generates affection to the place and how to find out and that includes the possibility of losing precisely because of a path unconventional.

Audiowalk is a "sound path" that consists of a kind of itinerant spectacle, in which the true actor is the lone spectator. What is called to make the viewer-actor of *Audio-Walk* is the place of departure of the trail, where he received a portable CD player

with headphones. At his command part a soundtrack made up of dialogues and sounds that make up a theatrical play in the making, closely correlated with the architecture of the city, which then becomes an intuition stage. The viewer is driven by specific indications given by the main character of registration, which performs the function of "carer", against the backdrop of monuments and buildings of the city, along a predetermined route that tells a story. At the end of the walk (50 'about) back to square one where the equipment is returned.

The work is driven by the need to speak of public space and how people live, on the relationship between the construction of the future and the role of memory, personal and collective identity. The Audio-Walk experience exists only thanks to the people who carry with them the CD through the unpredictable weather conditions, traffic, lights and sounds "from outside". «The Parma we use as a starting point and context for our play is a place that is transforming. We cross the city without a goal, led by the look of a man more concerned by an unexpected detail that the logic or the historical explanation of what he sees».



Figure 1: CD rom “Audio-Walk. Errare”

2.2.2 Soundscape Monte Stella (G. Anzani): In this territorial area consists of about 30 countries, the sound of 80 bells, overcoming the physical barriers, formed the structure of communication of the territory of Mount Stella, a soundscape that is a fundamental part of the cultural landscape of Cilento. It is interesting the identity of this territory communicated mainly from this system guidance tied to a mode of enjoyment of the place that belongs to the past when the bell yet (in their size and verticality) were the real points of reference. (recognised by UNESCO).



Figure 2: Monte Stella sound map of bells

2.3 Paradigm “Cityvideocartoons”

The world of animation, now entered logics and practices of use in the field of videogames, web, training is not yet sufficiently exploited in the field of communications for the territory. I believe that use metaphorical languages and unrealistic to communicate and enhance a landscape, a city, an architecture is a way to transfer messages very indicated in this area.

2.3.1 Unconventional landscapes (E. Giunta, R. Trocchianesi):

This project is just one of the artefacts of communication products within a wide search for the enhancement of the territory in question was commissioned at the Politecnico di Milano, Polo Regional Mantua (direction of research: professors. F. Schiaffonati, C. Stevan; coordination Direction: prof. Mussinelli E.; scientific coordination: professors. F. Celaschi, D. Fanzini; responsible research units: G. Casoni, R. Trocchianesi) from a cluster of 26 cities near Mantua (Oltrepò Mantua), the province of Mantua, the Chamber of Commerce and the Province of Mantua.

In this context, the research unit of design work has contributed in terms of recognition and display of the area, construction of the scenarios, generation of 6 pilot projects (through a workshop based on the model of research-action) to enhance the territory and by building the brand “Oltrepò Mantua” with its logo and corporate image and the development of various artefacts of communication including “cityvideocartoons” This is a very short promotional spot for the territory to describe the characteristics of the same languages through unconventional suggesting a mode of seeing the same place on an unconventional. The language of cartoon becomes the instrument through which to discover hidden the identity of a geographical area hitherto little recognized as characteristic and at the same time use a tool and a technique outside the sphere of tourism.

These “cityvideocartoons” were projected BIT (International Tourism Stock Exchange) in February 2008 during the presentation of Oltrepò Mantua brand and its image.



Figure 3: frames of Oltrepò Mantua cityvideocartoons

2.4 Paradigm “Chromatic and material trips”

The chromatic and material trips are “virtual places” where the visitor-user immerses himself according to the logic of a hypertext screenplay that makes the experience of fruition a level of deepening cultural heritage whether work of art, city or heritage intangible, a new discovery.

2.4.1 Videoart “Carlo Mattioli” (G. Marcenaro, P. Boragina): In 2004, at Voltoni di Guazzatoio the National Gallery of Parma was held the exhibition of Carlo Mattioli, a great interpreter of Italian painting of the second twentieth century.

In Mattioli’s paintings the suspension time associates with representation of a world almost perceptible, becoming the disturbing expression true nature of the work of art: a wonderful story of leaving moment imaging. Mattioli has perceived the landscape in its more variables. The exhibition might seem a move by topics: the vision of heaven, water, botanists motions, of land explosions, colours in the fields of heated poppies. These are the frescoes of a mysterious world, initiatory world. The paintings by Mattioli go beyond any quota meaning: burn, “sacrifices themselves” to discolor themselves to reach the essence, the shadow forms, the whispers of trees frozen, to property abandoned, although some signs of forward perceived in braided trying to maps boundless.

What Mattioli is a poetic journey into another dimension, beyond the canvas. This was a hunting magic.

The project provided for the exhibition of over 100 paintings and tables of the master allowing visitors to admire the technique “material” of his paintings in which, dense clusters of color oil were interesting thicknesses and “light & dark”. In addition to this type of use “direct” was provided a room in which was the projection of a video produced in digital document to “immerse” the visitor into a dimension “other” compared to the proposal in the other exhibition halls. Here the materiality of the paintings was accentuated by treating the findings of color as geographical surveys of the territory, overturning the scale reading from space and giving the visitor esplorabili new horizons and new prospects “in the bird’s eye”.

2.4.1 The Organic City: Of particular interest this project website that lets a trip so intangible as suggestive scenarios within urban Americans. It chooses a narrative genre (comedy, horror, fantasy...) and from there can start a real experience through the suggestion of story. Even the staging becomes expedient for an entertainment alternative which also works in cultural terms.

Storytelling has been used to entertain and communicate ideas for thousands of years. Throughout history, narrative has evolved in parallel with emerging technologies, such as the written alphabet, radio, film, and television. Today’s new technologies, including the Internet, databases, and mobile devices, allow us to author and communicate stories faster and in more ways than ever before.

The Organic City, which will emerge organically during 2005-06, will use these technologies to create a collaborative digital storyworld centered on the downtown Oakland areas surrounding Lake Merritt.

The project seeks to connect with the community through this website where you can find and tell stories about local places. In addition, the project offers mobile media that can be experienced onsite with mobile media players and Pocket PC’s. Ultimately, we hope the project will allow us to explore the relationships between place, story, and community; as well as the ways in which new technologies can enhance our appreciation for these important components of human identity and experience.

In a precise area of the site you can listen, tell or let accompany the city through the stories.



Figure 4: home page web site www.theorganiccity.com



Figure 5: link storytelling web site www.theorganiccity.com

2.4.2 Torino Piemonte Videobank: Another interesting case in which technologies are the vehicle and at the same time the content that allows a journey, an exploration into the cultural heritage of an entire region (Piedmont), is the archive online portal Turin Piedmont Videobank. This is a portal in three languages that contains video and information on Piedmont, made available, free of charge by institutions and public and private entities for the press nationally and internationally.

Managed through a database that allows the cataloguing of countless data, allows the user to use a simple and quick in finding and research of content they want. The videos in the portal are divided into themes, representing Piedmont, the Province and the City of Turin: economy, culture, tourism, geography of the territory. They are also viewed and downloaded from the site materials deepening and connected to the thematic sections, and therefore already selected by subject.



Figure 6: web site www.torinopiemontevideobank.it

3. CONCLUSIONS

The cases that I reported in my opinion return a clear picture of the various ways in which the world of design is moving to respond to new ways of enjoyment of cultural heritage. The complexity of articulation cultural offer fronts imposes new design.

In this regard, the digital language is an interesting platform for testing this front design that interprets the new multimedia technologies as a place of narrative and as regards working to define new ways pervasive and experiential to know the territory. The design may make the management theatrical system components, technological and technical giving shape to multimedia artefacts can change the dynamics of the cultural heritage communication to its different scales (from the territory to artistic artefact)

4. REFERENCES

References from Books

- Barthes R. 1999. *Variazioni sulla scrittura. Il piacere del testo*, Einaudi, Torino, p.16/p.25
- Bauman Z. 2006. *Modernità liquida*, Ed.Laterza, Roma-Bari
- Branzi A. 2006. *Modernità debole e diffusa*, Ed.Skira, Milano
- Brook P. 1998. *Lo spazio vuoto*, Ed.Bulzoni, Roma
- Casoni G. Fanzini D. Trocchianesi R. 2008. *Piano di marketing strategico per l'Oltrepò Mantovano*, Ed.Maggioli, Milano
- Pine B.J. Gilmore J. H. 2004. *L'economia delle esperienze*, Ed.Etas, Milano
- Rondolino G. Tomasi D. 1995. *Manuale del film. Linguaggio, racconto, analisi*, Ed.Utet Torino

References from websites

- www.audiowalk.it
- www.perypezeurbane.org
- www.theorganiccity.com
- www.torinopiemontevideobank.it

FRAMEWORK METHODOLOGY FOR VIRTUAL MUSEUMS FOR THE DESIGN OF VISITING SCENARIOS BASED ON THE BEHAVIOUR OF REAL EXHIBITION VISITORS

F. Kiss^a, M. Török^a

^a INFOTA Research Institute, Foundation for Information Society, H-1507 Budapest, PO Box 213. Hungary -
(kiss.ferenc, torok.marianna)@infota.org

KEY WORDS: visiting scenario, visitors' behaviour, image processing, experience content, data mining

ABSTRACT:

We have established virtual exhibitions on the web to preserve and present displays. Now we would like to present objects and exhibits in a way that it does not only reflect museologists' points of view of visiting the showcases but, with the help of cameras, we are following the regular visitors movements in the physical space and can make classification of them. With this system, we will be able to produce visits in a virtual exhibition that is very close to the realistic personal visits of an exhibition because there can be various stopover and direction selections be reproduced providing the same experience and feeling as in the course of real visits.

1. INTRODUCTION

The basic idea for the development of this framework methodology has been that we want to offer a special visual experience content in a virtual museum with a similar program or similar experience content as the visitors generate for themselves in a real exhibition. This is based on the observation of visitors' movements, visiting sights they enjoy during walking around the exhibition. We classify these routes and then based on them, we intend to describe how these visitors select a way of watching the exhibits. This pattern should be transferred to the virtual museum as per scenario for a virtual exhibition. Why would anybody like to use this framework and these scenarios? We would like to map the various visitors' behaviours to contribute to the understanding of the types of relationship networks that are recognized by the visitors among the exhibits. This could also provide a feedback for the curator of the exhibition – whether his original concept is evident and acceptable for the visitors – or it can give an idea to develop further, alternative 'stories' in the subject. There are some possibilities to use the new scenarios, such as:

- the curator would like to preserve the temporary exhibition in the virtual world,
- the curator would like to present artefacts stored in the warehouse in a virtual way because of lack of exhibition space,
- the curator would like to better serve a wide range of visitors at the same time, who have different interest, age, cultural backgrounds,
- especially at exhibitions designed partly or mostly for children's attention who often disregard the planned route,
- visitor statistics of each individual items could give a detailed feedback as well.

In these cases, the program of the virtual exhibition could meet the needs in a more sophisticated manner.

2. OBSERVATION METHODS

There are a lot of studies about the behaviour of the museum visitors from different aspects: consumers, learners, etc. (Orr, 2004) These studies have tried to examine the motivations of

the visitors for going to a museum (Edwards, R.W., Loomis, R.J., & Fusco, M.E., 1990) as well as the collected impacts and influences: the results of the visits (Pekarik, A.J., Doering Z., Karns, D.A., 1999), (Prince, D. R., 1990), (Ornager, 1997). All these works have used human observers with open or closed questionnaires, tests or checklists.

In our suggested framework, we would like to eliminate the subjective elements of the observation of the visitors' sight. The expression is used all through the text in the meaning: how the visitor follows the objects by his eyesight. On the other hand the basic aim of our research is to find out what effects are caused by the setting of a real exhibition, what are the experiences they cause to the visitors. Here, experience means both the immediate reactions in the vision of the visitor (way of visiting the whole exhibition) and long time effects (the remaining thoughts and feelings, the conclusions of the encounter).

We have to face three types of observation problems. There are legal issues to be answered, physical observation questions and technical observation matters.

Regarding the legal issues, first of all, we have to mention that in the European Union data protection and information freedom regulations are based on a common theory and only the national regulations mean some variants in the extent and in the practical usage of this serial. Nevertheless, all of the European Union and in most of the developing countries as well, observation should be notified or advertised in the lobby at the entrance of the museum or at the properties where the visitor can certainly meet this announcement. During the observation and obviously, in the visual profiles generated by the observation about each visitor included in the observation, the profiles are somehow unique to the person, although we do not connect them to other personal data like names, addresses, etc. These data will be appropriate for explaining how the visitors walk around the exhibition rooms, how they make their own selection of exhibits to see. Based on the timing of their movements, we can understand what kinds of exhibits are more important for them. All this are data and all these are attributes from which the individual profile related to the visitor can be established. That is why even in the visual profile, we cannot connect them to any other personal data. It should be strictly stored as anonym data

and there must not even later be any connection either to other personal or time generated data. Individual profiles can be published only in aggregation of at least five profiles assuring that no original profile can be retraced from this aggregation. Based on the international regulations and suggestions, the individual profiles should be deleted after losing their relevance.

The problems with human observation are different. The human observation, if it is managed independently in every room of the exhibition provides a lot of separated details of the visitors' route during the entire museum visit. The problem is in setting up the connection of the individual sections because the observers usually do not create identifiers for a visitor for the whole observation period in the different sections. That is why we cannot generate a full profile, so we cannot generate a whole scenario about one visitor's behaviour, visiting habits.

In the course of the observation process, ten times more visitors in a single room require more attendants in the observation. A larger number of visitors can cause overlapping of each other's visits and need a special program to follow them, so that it could appropriately register their activities. If the human observers pursue them room by room, the visitors can be followed only by guided tours or a somehow sequentially managed grouping of the people. During this process, guides or other accompanying persons get the task of observing the behaviour of the visitors and simultaneously they have the right and possibility to control the sight of the visitors. It means that they can slightly force or direct them towards the sights, what to look at and what to see in the course of the exhibition. For this reason, it does not give us a natural behaviour scenario about the visitors, although in larger groups or in a crowded environment a part of the group is generally walking almost independently and looking around almost autonomously from the group. At the same time, the larger groups require more attendants during observation whereas it is hard to measure their activities on the time scale because the guides have a fix scenario during the visit pushing a group through the visiting rooms within the scheduled time.

There are different types of technical observations as well. If a museum or exhibition uses movement or presence detectors established in given zones, we have only detections about somebody moving in the zone of the detector but we have no exact data about whether he is a unique individual who moves around or some individuals walking up and down. We get no idea about what they are looking at and in conclusion, we cannot manage to detect them within a given time scale because the detector records whether there is a movement or not in its zone. Thus this movement detectors in this zone solution do not generate profiles at all and do not follow the direction of the visitors' sight, so they cannot be applied appropriately for our goals.

There are various more modern technologies using RFID tags to follow the movement of visitors. It could be on a piece of paper, a bracelet as a ticket or the tickets themselves could be the RFID stickers. Although, the detection of this RFID unit is not exact from a larger viewing distance or larger registration distance. Primarily, we can detect them passing through given points, like crossing a door, interlacing one or two meter wide zones. Numerous detectors are speeded, if we want to detect whether the visitor moves closer to an exhibited object, sculpture or painting. We have to make the selection from among the RFID signals of the exhibited objects, which are too close to each other, and there is a possibility of misregistration.

Finally, this registration does not follow the direction of the visitors' sight either.

Researches have had to be continued to find another method for the elimination of obstacles during real examination. The purpose of it is to obtain clear-cut results of the visitors' behaviour and habits when walking around an exhibition. Lastly, the observation with video cameras seemed to be a solution for all of the problems mentioned above. If we have a regular rectangular room, one camera with the appropriate objective is enough for observing the typical movements of the visitors. One camera is not enough in the following cases:

- the room is too large,
- the room has a complex shape,
- the exhibits are not only hanging on the wall but they are placed all over the room,
- other barriers are standing in the room that could cover the visitors from the observing camera.

In conclusion, we have to set up several cameras observing different zones in the room. In these circumstances, the zones should be overlapping. Nevertheless, this solution may also raise a problem: it is hard to generate the visiting paths from video streams. It needs processing algorithms and a complex picture analysis but it is a very easy way to monitor what visitors really see based on the time scale or on the physical position as well.

3. TYPES OF VISITOR ROUTES

There are four types of visitor routes:

- Crossing Visit
- Left Round Visit
- Right Round Visit
- Expatriating Visit

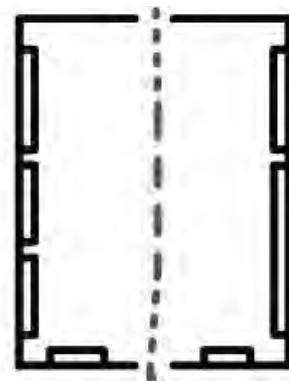

Figure 1: Crossing Visit (CV) – no interest

The simplest is the Crossing Visit (CV) when the visitor crosses the door and the room towards the next door and he may be looking around but does not stop or stops only for a moment and his view is mainly focusing on the direction of the movement and not on the exhibited objects. Figure 1 demonstrates a sample crossing visit path including speed information. In the figures 1-4 the more continuous the path curve is, the slower the visitor's movement becomes.

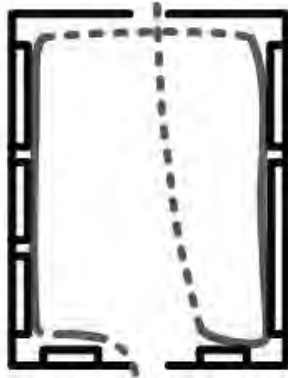

Figure 2: Left Round Visit (LV) – an interested visitor

The second type is the Left Round Visit (LV, see example in Figure 2). It means that the visitor enters the room, he looks round from the left hand side. This round path could contain movements and stops at the exhibited objects, could contain back steps to previously seen objects, going around an exhibited object in the centre of the room. Nevertheless, the main type of the movement is a sequential visit around the walls, around the room and finally at the end of the round visit crossing the room and going to the next door.

The third type of visit is the Right Round Visit (RV, see example in Figure 3), it is similar to LV in its structure.

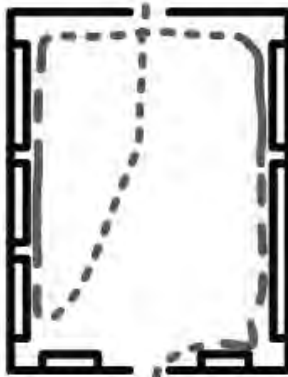

Figure 3: Right Round Visit (RV) – a sequential visit giving chance for every object

Finally, the most interesting type is the Expatiating Visit (EV, see example in Figure 4). During this visit, the visitors do not follow the suggested direction for visitors, neither the scenes that the organizers intended to show them in the exhibition, nor the way the museum have prepared for them. The visitor dismisses the suggested routes and is wandering in the room, changing its visiting direction all of a sudden, going from one interesting object to another, sometimes crossing the room, going forward and back, left, round and right. Conclusively, this complex movement path describes that this visitor visits the exhibition based on his own interest, based on his impressions received from the objects for the first sight.

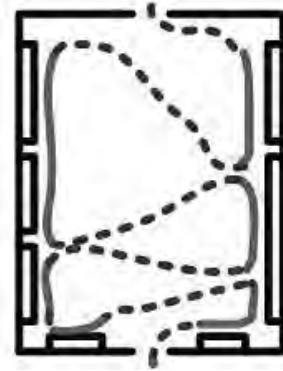

Figure 4: Expatiating Visit (EV) – impression driven

These definitions of rules are of course depending on the structure of the exhibition. Thus, for example, if the room has one or more than two doors, there are several other path patterns. Alternatively, if the room has a complex shape, not a common rectangular one, the meaning of a Left Round Visit or a crossing one could be visually different but topologically it would be the same. On the other hand, for example, the path of an LV can be distinct in the same, non-rectangular exhibition room, as it can be seen in Figure 5 and Figure 6.

4. OBSERVATION WITH VIDEO CAMERA

Our idea is the individual routes generated by the visitors' movement and based on the movement of the visitors' sights, could be described during the analysis deriving from the video analysis on a timeline. There are some vigorous techniques for following the movement of heads on the video streams (Kropatsch, W.A. – Bischof, H. (ed.) 2001), although these methods are used for an individual stream.

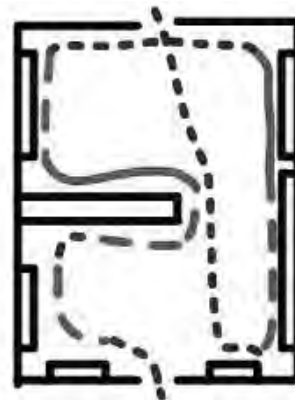

Figure 5: LV in a non-rectangular room

As it is mentioned above, if we have to use more than one camera because of the complexity of an exhibition room or because of the exhibition covers more than one room, we have to join the fragments of a given visitor's route. The overlapping zones (see Figure 7, cameras in the corner) have to generate the same identifier to the same visitor for automatic linking based on the mathematical transformation of the pictures about moving persons however it needs good quality video and image processing for face recognition. If the visitor crosses the

overlapping area several times, the visitor's route should be kept integrated (Figure 8, cameras in the corner).

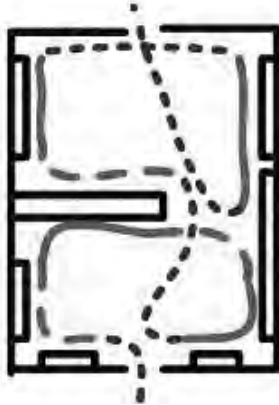

Figure 6: Double loop LV in a non-rectangular room

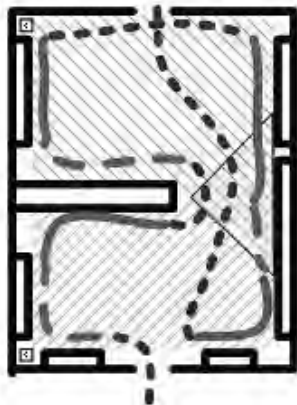

Figure 7: Overlapping camera zones

Finally, using pattern recognition techniques and mathematical picture transformations, we get the unique paths of the individual visitors, as a series of points with discrete (X,Y) coordinates and time stamps. The time stamp is generated based on the time scale of the video stream.

5. EXTRACTING THE SCENARIOS

In the next step, we have to make a proportional conversion of these paths to a standardized timeline for facilitating the easy comparison of these paths. The interesting point for us is where or at which objects the visitors are standing for a longer time as the time interval spent with the perception of an exhibit can appropriately describe the visiting experience of these objects. This kind of normalization significantly eliminates the impacts of different movement speeds originated by e.g. the different age of the visitors or the slow movement caused by crowd.

The final objective of this analysis is that we would like to classify the routes based on these main types. A group stemming from a main class should contain almost the same experience content, eliminating the natural spread of movements (the (X,Y) co-ordinates) on the physical space. This profile selection classification is based on the use of data mining

tools. The technique is to extract useful information from recorded data.

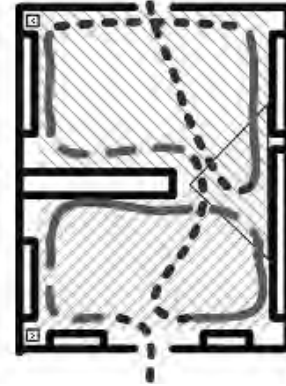

Figure 8: Overlapping camera zones in a multi entry room

The term data mining is often used to apply two separate processes: knowledge discovery and prediction. Knowledge discovery provides explicit information that has a readable form and can be understood by a user. Forecasting or predictive modelling provides predictions of future events and may be transparent and readable in some approaches. By the application of this method, we achieve to find out more information about the experience content of the classes.

There are other possible uses of these data. The visitor statistics of each individual item can give a detailed feedback to the curators:

- which items were the most preferred during the visits,
- whether a given artefact drew a special attention of the visitors,
- what was the popularity preference order of the exhibits in a given room or area,
- is there any item missed almost completely,
- whether the visitors read the introduction panels,
- where were crowds formed by the visitors, where was a bottleneck.

Although most of these statistics are used nowadays, their collection requires considerable human effort. One of the advantages of our suggested method is that it provides this information in an automatic way.

In the course of the mining of the general patterns of the attributes, the classification using the exhibit's metadata base, we can understand what the typical and main attributes are of the experience content in a given class. If we can describe the content patterns in a human language for better understanding and for marketing purposes as well, we can produce a formal or somehow formalized definition of what a content pattern means and what content patterns the visitors generate. It also identifies the typically required contents.

The ultimate aim is to set up these content classes and apply them for a virtual exhibition by following the visiting scenarios experienced, so that we establish a similar kind of feeling, impression, content pattern and experience for the users of a virtual exhibition than for those of a real physical one.

Having understood the statistical results and the class profiles, we can develop the supply of the museum shop with postcards, artefact copies, t-shirts, etc. In the virtual museum, we can develop an online shop with downloadable posters, videos, publications, artefact copies to be ordered, etc.

6. CONCLUSIONS

In this suggested 'OCAGU' framework, we follow five steps from starting the observation to generating a new virtual exhibition:

- Observe the sight movement of the visitors
- Classify the routes
- Analyze the routes for experience content retrieval
- Generate experience content descriptors as scenarios
- Use the scenarios for establishing new virtual exhibitions with 'similar' content

By the description of the visitors' sight, routes can be established. If the route can be classified and if we can generate classes from the individual profiles containing similar or closely related experience content, we can analyze these routes for retrieving these experience content. We also can understand the attributes of the visitor paths of the same class members and we can generate descriptors of experience content. It will produce a scenario for understanding and formalizing the facts that belong to the physical visitors of a real exhibition. Finally, we can use these scenarios for establishing new virtual exhibitions with similar exhibition contents.

If a virtual museum, a virtual exhibition can offer a series of various kinds of experiences for a visitor and in the same time it can even classify the type of users: who should use that experience, or, in other cases, if it can suggest a type of experience with a well-defined content and title, we can achieve better visitor encounters in the virtual museum and it could highly increase the number of visitors as well.

Besides, it can serve as a kind of management information as the technical environment in which the OCAGU framework runs, also provides a lot of statistics and information about the exhibits impact to the audience.

7. REFERENCES

References from Books:

Edwards, R.W., Loomis, R.J., & Fusco, M.E., 1990. Motivation and information needs of art museum visitors: a cluster analytic study. *ILVS Review*, 1(2), pp. 20-35.

Kropatsch, W.A. – Bischof, H. (ed.), 2001: *Digital Image Analysis*. Springer, New York, pp. 221-235.

Ornager, S., 1997. Image retrieval: Theoretical analysis and information seeking studies on accessing information in images. *Proceedings of the 60th Annual Meeting of the American Society for Information Science*, 34, pp. 202-211.

Pekarik, A.J., Doering Z., Karns, D.A., 1999. Exploring satisfying experiences in museums. *Curator*, 42(2), pp. 152-173.

Prince, D. R., 1990. Factors influencing museum visits: An empirical evaluation of audiences. *Museum Management and Curatorship*, 9, pp. 149-168.

References from websites:

Orr, T, 2004: The Information-Seeking Behavior of Museum Visitors. A Review of Literature, May 19, 2004, http://home.earthlink.net/~toriorr/ROL_MuseumVisitors.doc (accessed 04 July 2008)

USING GAMES TO PRESERVE AND EDUCATE

A. Laghos^a

^a Cyprus University of Technology, Applied Arts and Communication Faculty, 6303 Limassol, Cyprus –
andrew.laghos@cut.ac.cy

KEY WORDS: Games, Cultural Heritage, Europe, Multimedia Technologies, Education

ABSTRACT:

One of the principal pillars of EU doctrines is the free flow of people among all countries of the European Union. It is also the EU policy to encourage and support culture as a most valuable characteristic of the emerging EU. One way to make this more attractive to users is to offer educational games where people can learn at their own pace and time and have access to other users and learners. In this case study, an educational game has been developed to teach children about the different countries of Europe, their characteristics and their culture, and incorporates quizzes like multiple-choice and true or false questions where the learners can test their knowledge in a fun and visually attractive way. The study used the design, implementation, evaluation method whereby the prospective users of the game were identified and the learning objectives set out. Following this, the actual game was implemented using multimedia authoring tools. The application serves as a pilot study and includes an encyclopaedia section which is used as a reference and information resource for the students, and a game section which provides a fun and interactive way to test the students' knowledge and learning progress. The results show that combining pedagogy and entertainment can be an effective and engaging way to teach students about Europe's countries and to preserve their cultural heritage. Following the pilot project, a newer version of the game will be implemented enriching it even more with additional multimedia features like sound and movement with the purpose of making it more interesting, fun and lively. In the future, a web-based version of the game will also be developed enabling the students to form social networks and communicate with each other either to support their peers or just to socialize with each other.

1. INTRODUCTION

1.1 Motivation and Aims

Following the enlargement of the European Union, it was considered necessary to develop an application that would educate children about the countries of Europe while at the same time help preserve their cultural heritage. The application had to be engaging, visually attractive and fun to use so that the children would want to use it. In order to accomplish this, an informative educational multimedia game had to be created.

This paper focuses on the description of the project organization, the use of technology and the lessons learned through the process.

1.2 Paper Overview

In section 1.3 there is a discussion of related research work and the importance of games in education and culture. The paper continues with an explanation of the methods used and the results are presented and discussed. The paper ends with future research directions and an overall conclusion of the project.

1.3 Related research work

Games are an important part of most children's leisure lives and of our culture as a whole (Kirriemuir and McFarlane, 2006). Until recently games were considered a distraction from homework, however today researchers and teachers are asking how this medium can be used to support learning. (Kirriemuir and McFarlane, 2006).

The global gaming market is worth billions of dollars. In 2002, the world market for games was 16.9 billion US dollars. (ELSPA 2003).

Studies show that games have a motivational power which makes learning fun. People play computer games to win or achieve a goal thus the key to motivation is winning (Becta, 2001). Motivated learners can learn almost anything (Siang and Rao, 2003).

A 2002 study by McFarlane, Sparrowhawk and Heald (2002) revealed that "85% of the parents evaluating games with their children believed that computer games contributed to learning as well as providing entertainment". Therefore, it is the findings of researchers, but also the opinions of the parents and the children playing the games that computer games aid learning in a fun way. These reasons underlined our motivation for creating an educational game to familiarize children with the countries of Europe and their culture.

Furthermore, it has been shown that playing games also benefits school performance. (Mitchell and Savill-Smith, 2004). Linear cause-and-effect games encourage means-end analysis strategy, while adventure games encourage inferential and proactive thinking (Pillay, 2003).

All these tell us that games should not only be considered as a mode of entertainment, but also as a dynamic tool which can motivate and interest children to learn by means of a more progressive and technological way.

2. EXPLANATION OF METHODS

This section describes the case study and explains the methods used (design, implementation, evaluation) in more detail. In addition the results are presented and discussed.

2.1 Design

2.1.1 Project Organization and Content Outline: The project was initiated with a proposal stating the purpose and aims (as mentioned in section 1.1). Following this an organizational timeline was created (table 1) to plan the development of the application.

Project Organization Timeline	
Week 1	Week 2
Project Proposal	Project Stage 1: Research
Project Time Line	Text
Project Flow Chart	Images
Identification of Audience	Relavant Sites
Weeks 3, 4 & 5	Weeks 6 & 7
Project Stage 2:	Project Stage 3:
Layout Design	Application Development
Image Editing	Component Compilation
Text Editing	
Week 8	Week 9
Project Stage 4:	Problem fixing
Initial Testing	Redesigning
Weeks 10 & 11	Week 12
Beta Testing	Project Stage 5:
Packaging & Labels	Final Production

Table 1: The project’s timeline organization

2.1.2 Target Audience: The next step was to identify the target audience in order to develop the software to cater to their needs. The target audience of the specific application was elementary and high school children between the ages of 6-18 but can also be used by college students and adults as well.

2.1.3 Content Outline: Following the identification of the audience, a content outline was prepared showing the various sections of the application in a hierarchical structure, as can be seen in Figure 1.

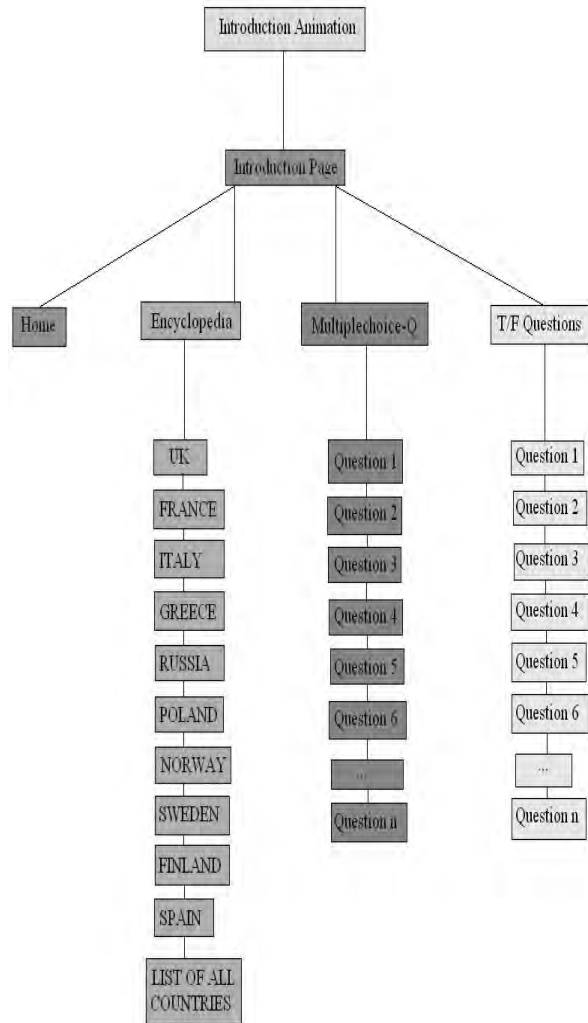

Figure 1: The project’s hierarchical organization

The application begins with an introductory animation which intends to grab the children’s attention right from the start.

The application content has three sections: the encyclopedia, the flag questions (multiple choice) and the true or false questions.

Encyclopedia: This section comprises of the outlines and shapes of the countries, their national flags, geographical features like areas and population as well as cultural information for each of the countries

Flag Questions: In this section users can play the first of the two games. They are asked to identify which country a displayed flag belongs to by selecting one of four multiple choice answers.

True or False Questions: In this section the users can play the second of the two games. In this case the game is more demanding as the users must have a larger knowledge base about the European countries as the content includes specific country characteristic and cultural questions. The users answer by clicking the True or False buttons.

2.2 Implementation & Use of technology

The game has been implemented using the educational version of Macromedia Director MX 2004. In order to run the application, the user's computer must have the Shockwave player installed. A standalone .exe version of the game has also been developed enabling users without Shockwave to be able to play the game.

In addition, for the graphics, Photoshop and Illustrator were used, and Adobe Flash was used for the animations. The Sound Lab software was used for the sounds.

The application can be run on all computers in public and private schools as well as home computers that meet the minimum requirements of a Pentium processor and 35mb of free space. An alternative option to this is to run the application directly from its CD-ROM eliminating the need of hard disk space to install the application on.

The game features include the use of bright colors making the game more attractive to youngsters, animations which capture the users' attention, and sounds which add a 3rd dimension to the game's entertainment value.

When the application is run, it starts off with an introductory animation. Figure 2 shows a screenshot of this animation. This was done so that the movement of graphics on the screen would gain the children's interest right from the start.

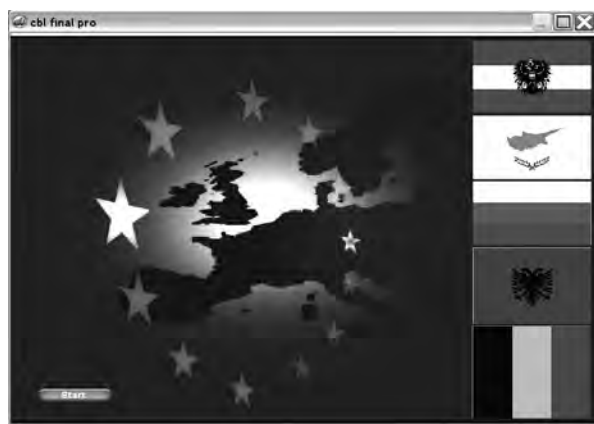

Figure 2: Introductory Animation of the game

To begin the game the user has to click the Start button which is located on the bottom left of the screen. The users may choose to watch the whole animation, or may choose to skip it. This can be done by clicking 'Start' during the animation therefore interrupting it and entering the application right away.

Once the user enters the homepage of the application, he/she is presented with a welcoming note that explains the purpose of the project in a simple and easy to understand language. An image (figure 3) is also displayed showing the different countries of Europe on a map.

The user may then choose between 4 options on the menu: Encyclopedia (to get information about Europe's countries), Flag Questions and True of False Questions (the two games of the application) and Home (to return to the starting page of the application). The menu bar is constantly displayed throughout

the different sections of the application enabling the users to freely navigate around.



Figure 3: The Home section of the game

When the users click the Encyclopedia button they are presented with a screen that informs them about the purpose of the section. They can then enter into the information resource by clicking the start button as shown in figure 4.

The users can then browse through the countries and read historical, geographical and cultural information for each country. The countries' geographical shapes and flags are also displayed as can be seen in figure 5. The users may also click the back and next buttons that are available to get access to previously viewed countries or to randomly view another country's information.



Figure 4: Information about the encyclopedia section



Figure 5: The Encyclopaedia section of the game



Figure 7: An example of the game's Flag Questions

When clicking the Flag questions button, the users are presented a screen with instructions on how to play the particular game. Figure 6 shows a screenshot of this screen.



Figure 6: Instructions on how to play the game

There is a note which welcomes the users to the section and explains to them what they have to do to play the game. The note ends with "Good luck" and an emoticon "-:D". This gives the game a pleasant tone but also speaks the children's language with the use of smileys which they are already accustomed to from their chatting and sms usage. When the users click Start the game begins. In this section they are presented with a flag and four options where they have to choose which country the flag belongs to. An example of this can be seen in figure 7.

Figures 8 and 9 show the system's responses to correct and incorrect answers respectively. In addition a representative and familiar sound is played after each users' answer to indicate whether the response was correct (with a delightful beep or a crowd applauding) or incorrect (with a buzzing sound). Providing immediate feedback is important as to keep the users aware of their progress in the games.



Figure 8: Confirmation of a correct answer



Figure 9: Game's response to an incorrect answer

When a user gets the answer correct, he/she may then proceed to the next questions by clicking the continue button. If however the users get they answer wrong they may choose between two options: Try again (to have a go at the same question again) or Continue (to move on to another question). This was done so that the users are not locked to a specific question, giving them freedom of control to move around to other questions of the game without having to answer everything correct before doing so.

The Final section of the application is the True or False game which the users can access by clicking the T/F Questions button. Similarly to the Flag Questions, the users are first introduced to the section with a brief welcoming note and instructions on how to play the game.

Figure 10 shows an example of the applications T/F game. This game works very much like the multiple choice game of the application only this time the users only have two options (True or False) and the questions have to do with the countries' geography and culture. When the users get a question right or wrong, they are presented with the same screens and sounds as the flag game keeping the games consistent, therefore making the users feel accustomed to them faster and also making them easier to learn how to play.



Figure 10: An example of the game's True/False Section

2.2.1 Project Packaging & Channels of Distribution:

Following the implementation of the application, the game was professional packaged including CD labels and cover cases. The intended channels of distribution are print media like magazines and periodicals by attaching a multimedia CD. The target distribution are mainly family and teen magazines to get the game into the childrens' homes as well as their schools so that the children can learn while playing.

2.3 Evaluation & Results

The aim of this project was to create a fun educational aid. A user will have met all the project's requirements when he/she can answer all the game's questions without getting any wrong. In addition, although not originally planned, an informative encyclopedia section was included in the application. This enables the application to act as a reference source that the users can visit again and again to get aid for other related projects even if they have completed the game. This gives the project a unique reusability.

The application was also pilot tested by a convenience sample of 23 students (prospective users of the game) with the primary task of providing feedback on the application's interface and usability. The students were given the CD and had a chance to play the game for a few days. After that, informal interviews were carried out enabling free conversations to develop where they could inform us what they liked about the game, what they didn't like, what they would change, and what additional features they wanted.

With regards to the application's interface, the students reported that they liked the design and colors. They also liked the animation at the beginning, but wanted to see more animations throughout the application. In addition the students also liked the sounds because it made the game more realistic reminding them of the sounds in TV quiz shows. Another point worth noting is that the students found the users manual before each section/game very helpful.

On the other hand, the students who had evaluated the game had one main suggestion for improvement. At its current state the application does not enable the students to interact with other users of the game. The students wanted to be able to communicate and chat with other users, and also to be able to play with the games with the other users. Their suggestion for social interactivity is also backed up by research for various reasons that are explained further in the section that follows.

2.4 Discussion

In order for the game to include social networking features an online version will be developed enabling the users to connect and communicate with each other. Wallace (1999) points out that meeting in online communities eliminates prejudging based on someone's appearance, and thus people with similar attitudes and ideas are attracted to each other. Furthermore, group activities can be planned in advance which can increase the feeling of social presence and learner-learner interaction (Vrasidas & McIsaac, 2000).

Game-based learning mainly focuses on how a game itself can facilitate learning but it is claimed that the educational opportunity in computer games stretches beyond the learning activities in a game (Zaphiris, Ang and Laghos, 2006). By observing most people playing games, you can see them using the internet to download guidelines and participate in online forums to share strategies and talk about the game. Therefore, almost all game playing can be described as a social experience (Kuo, 2004) and in addition, learners perceive the content of the communication between them as an information source (Aviv, 2000). Thus, learning is not just embedded in a game itself, but it is also in the community of practice of those who inhabit it (Zaphiris, Ang and Laghos, 2006).

All these findings favour the inclusion of social interactivity features in our application and these will be incorporated in a future version of the project.

3. CONCLUSIONS

This project dealt with the design, implementation and evaluation of an educational multimedia application with the purpose of preserving the culture heritage of Europe's countries while at the same time educating students in a fun and engaging way. The final application consisted of an encyclopedia section

as an information resource and incorporated two games for testing the students' knowledge and progress. The application consisted of country related information like flags, history, culture and geographical information. The application was implemented in Macromedia Director and evaluated by students. Strengths of the game were found in its interface and navigation. A suggestion for improvement was the inclusion of facilities to enable social interaction between the users. The main lessons learnt were that social interaction can contribute to cooperation, peer-support, collaboration and learning. Future directions of the project will include an enrichment of the application with additional multimedia features like sounds and animation to make it more engaging and lively, while the focus will be on the development of a web-based version of the application. This web-based version will include a section where the students can include an optional profile of themselves, but more importantly it will encompass a chat-room and discussion forum where the students will be able to socially interact with one another and support their peers.

4. REFERENCES

- Ang, C.S. & Rao, R.K. (2003). Theories of learning: A Computer Game Perspective. *IEEE Fifth International Symposium on Multimedia Software Engineering*, 239-245. Taipei, Taiwan.
- Aviv, R. (2000). Education performance of ALN via content analysis. *Journal of Asynchronous Learning Networks*, 14(2).
- Becta (2001). "Computer Games in Education project" <http://www.becta.org.uk/research/research.cfm?section=1&id=2826> (accessed 1 May, 2008)
- ELSPA (2003). Report for ELSPA (The Entertainment and Leisure Software Publishers Association) "Interactive Leisure Software: Global Market Assessment and Forecast to 2006" <http://www.elspa.comserv/screendigestbrief.asp> (accessed 1 May, 2008)
- Kirriemuir, J. and McFarlane, A. (2006). "Literature Review in Games and Learning". Futurelab. http://www.futurelab.org.uk/research/lit_reviews.htm (accessed May 1, 2008)
- Kuo, J. (2004). Online video games in mental health. *Annual meeting of the American Psychiatry Association*, New York
- McFarlane, A., Sparrowhawk, A., and Heald, Y. (2002). "Report on the Educational Use of Games". TEEM. <http://www.teem.org.uk> (accessed May 1, 2008)
- Mitchell, A., and Savill-Smith, C. (2004). "The use of computer and video games for learning". ULTRALAB. Learning and Skills Development Agency. <http://www.lsda.org.uk> (accessed May 1, 2008).
- Pillay, H. (2003). An investigation of cognitive processes engaged in by recreational computer game players: implications for skills of the future. *Journal of Research on Technology in Education*, 34(3), 336-360.
- Vrasidas, C., & McIsaac, M. (2000). Principles of pedagogy and evaluation of Web-based learning, *Educational Media International*, 37(2), 105-111.
- Wallace, P. (1999). *The Psychology of the Internet*. Cambridge: Cambridge University Press.
- Zaphiris P, Ang J, Laghos A (2006). *Online Communities*. In: Jacko, J.A. & Sears, A. (Eds.), *The Human-Computer Interaction Handbook*. Mahwah, NJ: Lawrence Erlbaum & Associates

5. ACKNOWLEDGEMENTS

Special thanks go to Michael Zantides, Kery Nadjarian, Nikos Constanti and Charis Xeros for their background study and implementation of the game, and to the students who evaluated the application.

EVALUATION OF DIGITAL ARTIFACT DESIGN AT THE INTERACTIVE SALON

C. P. Gottlieb, D. Nilsson and H. Gottlieb

Swedish Forum for Cultural Heritage, The Interactive Institute, Box 1197, SE-164 26 Kista, Sweden - (chris,
david.nilsson, halina.gottlieb)tii.se

KEY WORDS: Digital Artifacts, Cultural heritage, Interaction Design, Visitor study, Exhibition

ABSTRACT:

The Interactive Salon was an ambulating exhibition space showcasing a variety of digital artifacts from various cultural heritage (CH) settings. The installations, both research prototypes and commercial products, try in some way or another to improve communication between cultural heritage settings and their visitors. Here, visitor communication involves the provision of visitor experiences, novel interpretations of CH material and learning. While digital technology carries great potential for the augmentation of visitor communication, it by no means necessitates an improvement, and in fact, as real-life applications have shown is often even detrimental to it. The key to successful digital artifacts is good design and one of the aims of the Interactive Salon was to function as a platform for a discussion about it. It allowed the exhibitors, Swedish Forum for Cultural Heritage at the Interactive Institute in Stockholm, to carry through a dialogue with both museum visitors and cultural heritage professionals regarding good design. This paper discusses good design in the context of some of the digital artifacts exhibited at the Interactive Salon. The field of interaction design specific to information technology provides valuable insights to our domain. Interaction design identifies several use qualities of digital artifacts as pertinent for the study of good design. In the context of digital artifacts at cultural heritage settings some of these use qualities are more relevant than others. We have tried to highlight specific parts of interaction design which we find especially significant to visitor communication at cultural heritage settings.

1. INTRODUCTION

Tools in the service of visitor communication and for the interpretation of cultural heritage (CH) have changed considerably since the proliferation of computers and information technology. The incorporation of computational technology (normally but not exclusively IT technology) into the design of *computational artifacts* (Suchman, 1987) (*digital artifacts* in the case of IT) has introduced unparalleled opportunities for cultural heritage institutions. The CH areas for its deployment are seemingly endless: restoration, conservation, learning, interpretative tools, accessibility issues, presentation, representation etc.

While the benefits of digital artefacts are seemingly obvious at a first glance, the true ramifications of their employment and design are less so. Traditional attempts to utilize IT technology in the realm of CH often involve a direct transference of an IT product into a CH context. While sometimes 'useful' they are often problematic and almost invariably suboptimal in terms of a visitor's learning and overall experience of the visit. Stemming from a military and commercial tradition, the computer and IT fields have long been concerned with efficiency and direct functionality. Many cultural heritage institutions have obliged this design focus with an epistemological tradition concerned mainly with the cataloguing, describing and exhibiting of artefacts. To attract more visitors in an ever more saturated world of diversions a shift is necessary which entrenches technology firmly in the *service* of the cultural heritage visitor. It is our belief that cultural heritage settings need to continue to be redefined by us in order to maintain a meaningful dialogue with the next generation of visitors, and that this can be achieved through thoughtful interaction design of digital artifacts.

Designing novel digital artefacts that break ground in the pursuit to improve visitor communication is a complex task.

Compared to traditional exhibitions and IT products they involve larger project groups and the introduction of new competencies (often absent in the CH sector). Most importantly, it requires reflective practitioners (Schön, 1983) dedicated to a multi-disciplinary and thoughtful approach such as interaction design. The field of interaction design is vast and its definition will shift from context to context. For our purposes, interaction design "refers to the process that is arranged within existing resource constraints to create, shape and decide all use-orientated qualities (structural, functional, ethical, and aesthetic) of a digital artifact" (Löwgren & Stolterman, 2004). This inclusion of design considerations that involve ethics, aesthetics (and even politics and ideology) in the design of digital artefacts is what makes interaction design such a valuable component to a CH Setting.



Figure 1: The main exhibition room of the Interactive Salon at Stockholm City Museum.

To this backdrop we would like to introduce the “Interactive Salon”, an ambulating exhibition space showcasing a selection of digital artefacts from various cultural heritage settings (Interactive Salon, 2006). This paper tries to highlight what we consider constitutes “good design” of digital artefacts at cultural heritage settings.

The exhibition space showcases projects from various collaborations between European research institutes, universities, museums and private enterprises. The aim was to present a wide selection of digital artefacts that deal with new technology and concepts for improving visitor communication and interpretation at art museums, cultural historical museums, science centers and heritage sites. The projects were chosen so as to provide a good cross section of the sector of digital artefacts. Furthermore, they try to cover a broad spectrum of partner constellations which are made of government authorities, SMEs, IT companies, foundations, museum content providers, heritage sites, media producers and research institutes.

The first edition of the Interactive Salon was exhibited at the Stockholm City Museum between October 2006 and March 2007. After which it was exhibited at the Hungarian Academy of Fine Arts (Budapest, June 2007), Eurographics 2007 (Prague, September), BMTA (Paestum, November 2007) and VAST2007 (Brighton, November 2007).

2. RESEARCH METHODOLOGY

The user-orientated qualities of the featured digital artifacts were evaluated in two questionnaires. The surveys were conducted at two locations where Interactive Salon was exhibited: Stockholm City Museum and at the VAST2007 conference in Brighton; in the former the target group was museum visitors, in the latter cultural heritage professionals. These were however of supplemental importance in the overall evaluation. The objective measuring of interesting qualities of digital artifacts is inherently difficult and more so in the context of cultural heritage where evaluation is less about efficacy of user performance to given tasks, and more about user learning, reflection and overall experience. With this in mind, it is more meaningful to evaluate digital artefacts in terms of what is called *articulation*. A view which defines knowledge of *good design* as an “ongoing debate, a conversation with other designers and design theorists, as well as design situations and the stakeholders involved with them” (Löwgren & Stolterman, 2004). In this case, the exhibition was continually manned by one of three researchers who in their role as evaluators of the digital artifacts on display, staged themselves as either passive, observing exhibition custodians or active guides seeking dialogue with visitors and CH professionals. The synthesis of our observations and reflections are presented below for four of the installations. We have tried to discuss these in terms of their most important use qualities.

3. THE DIGITAL ARTEFACTS

Touch of Kandinsky

Touch of Kandinsky is an installation in the form of an interactive carpet, aiming to increase the understanding of abstract art. It is a playful carpet which invites you to a quite different and explorative art experience (Gottlieb and

Simonsson, 2006). The carpet’s motif is based on Wassily Kandinsky’s painting “Group” from 1937. When the carpet is touched, walked on, rolled on top of, etc, it replies with music inspired by Kandinsky’s artwork. The various coloured patterns on the motif are tied to musical phrases which are played back as pressure is applied on the part of the carpet displaying the pattern. Kandinsky had many thoughts and ideas about the concept of synaesthesia – the coupling of different senses. In his work he relates his experience of colours’ sound and compatibility which each other. Touch of Kandinsky was developed by Swedish Forum for Cultural Heritage at the Interactive Institute.



Figure 2: A group of parents and children exploring the Touch of Kandinsky carpet.

Consisting of haptic pressure plates sown into the fabric of the carpet as well as audio equipment the installation provides an interface which appeals to the imagination of the visitor. The element of fantasy, curiosity and surprise contribute to the intrinsic motivation of the visitor to use it and allows a loose comparison to the concept of playability in the domain of games. A more apt approach in which to understand the captivating qualities of Touch of Kandinsky is through the concept of seductivity proposed by (Khaslavsky and Shedroff, 1999). Seduction is defined as a three tiered process of enticement (attracting attention and making an emotional promise), relationship (making progress with small fulfilments and more promises) and fulfilment (making good on the final promises and ending the experience in a memorable and positive way).

The interface attracts attention through its very novelty and once it has been established that a certain coloured pattern makes a certain sound the remaining patterns on the motif make an “emotional promise” which the visitor wants to explore in “small fulfilments”. The final promise is reached once the visitors has made themselves familiar with the entire motif and are able to express a personal performance, using the carpet as an instrument.

Another interesting aspect of this user interface is that it supports multiple visitors simultaneously who collaborate in forming the final audio expression. This motivates exploring the social action space use quality of the digital artifact. One such social intention was to allow visitors (primarily children and teenagers) to engage with each other in this creation of a mutual artistic expression. Especially positive was the way in

which this activity brought together young visitors who were not previously acquainted with each other.

A less foreseeable actual use of Touch of Kandinsky appeared in the context of the Interactive Salon at the Stockholm City Museum. A neighbouring seating arrangement to the carpet provided an ideal resting place for tired adults and was often utilized. This rather innocuous detail made a considerable impact on actual use: young visitors were allowed considerable time on the carpet while their supervising adults could sit down next to the work and ideas of Kandinsky. This more indirect way of exposing adult visitors to the artwork often created a more protracted timeframe in which they could contemplate ruminatively. To facilitate their access to the world of Kandinsky, the carpet was accompanied by a reproduction of the original painting, a suggestive Kandinsky quote in large font on the wall and an installation sign.

The Magic Book Scroll

The Magic Book Scroll installation was designed for the Science Center Gallery (Teknorama) at the Museum of Science and Technology in Stockholm. Teknorama is devoted to the five mechanical principles: the screw, the plane slope, the lever, the wheel and the wedge. The installation was a kind of blog aimed at young visitors where one could post images and text, using various messaging technologies: SMS, MMS and emails. Visitors were asked to find real world examples of the five mechanical principles and to send in their discoveries. This could be done either in conjunction with the exhibition visit or at some later point. This visitor correspondence was then available for browsing by other visitors from the installation user interface and its companion website. The installation was an interesting experiment in the construction of a new form of *social action space* for young visitors. In it, this demographic group was encouraged to reflect on technology and share their discoveries in a personal and meaningful way with tools which most of them are already well-versed in.



Figure 3: The Magic Book Scroll installation: A projector and wooden surface simulating an old book scroll and a basket of objects representing the "five mechanical principles".

While exhibited at the Interactive Salon functionality pertaining to the sending in of visitor reflections was offline. We therefore could not fairly evaluate the social action space which the installation gave rise to, but consider its user interface valuable to consider in its own right. The installation has the form of a

large, archaic book scroll from which visitors can view sent in material from other visitors for each of the mechanical principles. To view visitor entries for a particular mechanical principle, a wooden representation of the object is selected from a basket and placed onto a wooden surface next to the scroll's viewing area. Each object contains an RFID tag which is picked up by a nearby detector, it then relays the choice to the ceiling-suspended projector and displays the visitor entries for that principle onto the canvas (viewing area) of the scroll. By turning the scroll's wooden handle to the right of the canvas the visitor can scroll through the various entries. The Magic Book Scroll was developed by CID at the Royal Institute of Technology in Stockholm, Swedish Institute of Computer Science (SICS) and the Museum of Science and Technology in Stockholm.

The installation's user interface was unusual and fun and played a large part in the installation's successful. Most of the technology was hidden away from the user which gave it a magical quality since many visitors were unable to comprehend how it worked. The interface was so novel that some visitors needed a short introduction in how to use it. The installation's sign did have instructions but it was small, dimly lit and missed by some visitors. Furthermore, since out of its original context, the installation's big picture was hard to convey in the space the installation's accompanying sign. Most visitors benefited from a short guided tour, once done, most visitors would stay one for a couple of minutes and explore the many comments and images sent in by visitors in the original exhibition.

When thinking of the installation in terms of use qualities elegance, parafunctionality and seductivity come to mind. Elegance is the ability of a digital artifact to combine power and simplicity. This interface could not have been simpler and more natural as it is reduced to the trivial manipulation of physical objects, child's play if you will. On the other hand, these simple actions allow the visitor to navigate through large sets of data of both text and images. Parafunctionality is a quality which encourages visitors to reflect on our relationship with technology. The theme of the installation, the five mechanical principles stands as a stark contrast to the underlying and hidden digital technology, juxtaposing then and now. Furthermore, most visitors were at a complete loss as to how the installation interface worked from a technical perspective and made them often consider various solutions and technologies. The format, novelty factor and playful interface all contributed to making this a highly *seductive* installation.

The Arrigo VII Kiosk

Emperor Arrigo VII's mausoleum from 1315 includes a group of statues made by the artist Tino di Camaino. The masterpieces were dismantled in 1494 and the original placement of the statues is unknown. In an attempt to reconstruct the original arrangement, the statues have been reconstructed as accurate 3D models (Baracchini *et al.*, 2004). At this station, visitors could experience the results of this effort by exploring these models in 3D, by reading more about their history and by watching movies which illustrate various aspects of this work. Arrigo VII was a collaboration between ViHAP 3D, Visual Computing Laboratory, Istituto di Scienza e Tecnologie dell'Informazione (ISTI) and Consiglio Nazionale delle Ricerche (C.N.R.).



Figure 4: The Arrigo VII Kiosk: a desktop computer encased in and supported by a cylindrical stand.

This installation is quite a typical example of a techno-centric production showcasing fascinating new technological advances in a rather inaccessible way. In their choice of *design material* the designers of the software made the reasonable decision (from a technical point of view) of framing it within the web browser. This way it could be shown at the cultural heritage site as a digital kiosk and also on the Internet with minimal additional effort. The design material has however always inherent properties and can cause problems if they are not known or addressed at the design and implementation stage. It is relatively easy to minimize the browser (often unintended), and once minimized, often impossible to maximize. Young visitors would often take advantage of this fact and would then go on to explore the Windows operating system. This required frequent vigilance on the part of the guide. The software being contained in a web browser led to the natural decision of creating a desktop-like kiosk which attracted few visitors; this can be linked back to the discussion on the use quality of *seductivity*.

Another important use quality related to motivation is that of relevance & usefulness. These are motivational qualities which are extrinsic to the visitor i.e. originate from outside. For example, a school student might be motivated to use this digital kiosk to learn more about Arrigo VII as it is required for a school project. At times when a visitor has no intrinsic motivations and there is no school project, a digital artifact should play the important role of providing relevance and usefulness for the visitor, something the Arrigo Kiosk could have done better.

As described previously, elegance is an important use quality, none the less for digital artifacts at cultural heritage settings. Exhibitions and other CH settings are visited by people from various backgrounds and it is therefore essential to find a common denominator and to focus on digital artifacts which are intuitive and trivial to use. While the software is powerful: contains lots of technical text describing the cultural heritage site and technology, has an advanced 3D model viewer and other multimedia content such as pre-rendered 3D video; it is not so easy to use and understand, in effect alienating a large proportion of visitors. The browser-based user interface is flashy but cluttered and unclear as far as navigation. Furthermore the application is set to jump back to Italian (the original language) as soon as it hasn't been used for a while (cumbersome for the guide and deterring for visitors). The Italian text discouraged some visitors to take a closer look at the

installation. Some visitors lost interest in the installation before figuring out how to change the language as the buttons did not stand out in the cluttered interface. Exploring the 3D models was on the most part clear to computer-literate visitors. Some visitors (especially seniors) were however at a loss and would have benefited from clear instructions. One aspect of 3D model exploration that could be improved was the assigning of the origin for rotations and zooming. The model's preview on the right-hand side of the interface was non-intuitive and non-precise. The informational pop-ups accessible at specific points of the 3D model were valuable assistance to the user. However these were turned off by default and they weren't in any way advertised on the interface. Most visitors therefore missed this valuable feature if not assisted by the guide.

Hokusai Manga

Hokusai Manga is a digital reproduction of the first Manga book series ever by the famous Japanese artist Katsushika Hokusai of the Edo period. The Hokusai Manga installation uses a technical solution developed by the Swedish company Touch & Turn and was first exhibited at the Museum of Far Eastern Antiquities in Stockholm.



Figure 5: The Hokusai Manga installation: A touch screen and computer built into a stand.

The book is presented on a touch screen which itself is held up on a stand. The application is completely driven by the touch screen and offers an intuitive and clear user experience. The touch screen simulates the experience of flipping pages in a book with great effect. Each page is shown in its "original" condition and the pages are turned by dragging your finger across the screen. Some visitors, especially seniors, needed some coaching from the part of the guide to get the hang of flipping pages. Among other features, one worth noting is the zoom function which allows users to appreciate the finer details of each page.

Most visitors were pleasantly surprised to find that you could flip pages seemingly naturally with the stroke of a finger. Some confusion could appear if more than one visitor tried to interact with the book simultaneously. The application gets thrown off when the touch screen is stimulated at more than one point at a time. Most visitors needed no help from the guide and generally spend a couple of minutes browsing through the book.

Again, as seen in many successful digital artefacts there was an air of elegance about this installation. It was easy and very intuitive to use, mimicking the motion people are accustomed to

when reading a physical book. This seemingly small detail seduced many visitors to explore the installation in greater detail. This seductive quality was due to the novelty factor as most visitors had never seen this type of interface solution before. This digital artefact serves as a good example of how an element of surprise and novelty is an effective means of motivating a visitor to explore the cultural heritage at hand.

4. SUMMARY

Looking at the Interactive Salon exhibition as a whole, many visitors (especially teenagers and young adults) expressed a wish to have more features of interactivity available at the installations. One way to improve on this for future editions of the exhibition would be to feature projects still “online” and specifically tailored for the Interactive Salon. The less conventional digital artefacts such as Touch of Kandinsky and Magic Book Scroll attracted more visitors, and more time was spent by these than by installation of a more traditional guise. Exhibiting various digital artefacts, some exemplary of good design, others less so, next to one another, provide a valuable context in which designers, CH professionals and visitors can discuss good design and its meaning to visitor communication. Use qualities of digital artefacts we found particularly valuable in the context of visitor communication were those connected to *motivation* (playability, seductivity, relevance and usefulness). Also common to many of the better digital artefacts was the element of elegance. In future work we would like to evaluate digital artefacts for which it would be meaningful to discuss the use quality of *anticipation* and to see how it affects communication. This particular use quality deals with the dramatic structure of a digital artefact and various forms of plot-driven interaction.

5. REFERENCES

- Baracchini, C., et al., 2004. “Digital reconstruction of the Arrigo VII funerary complex”. *Conference Proceedings of VAST 2004*, pp. 145-154.
- Gottlieb, H., and Simonsson, H., 2006. “Designing narrative and interpretative tools”, *Engage* 18.
- Interactive Salon, 2006. A touring exhibition about new technologies and concepts for communication with visitors in the context of cultural heritage. <http://www.tii.se/projects/interactivesalon> (accessed 25th of June, 2008).
- Khaslavsky, J., and Shedroff, N., 1999. “Understanding the seductive experience”, *Communications of the ACM* 42(5), pp. 45-49.
- Löwgren, J. and Stolterman, E., 2004. *Thoughtful Interaction Design – A Design Perspective on Information Technology*. Cambridge, Massachusetts: The MIT Press.
- Schön, D. A., 1983. *The Reflective Practitioner - How Professionals Think in Action*. New York: Basic Books.
- Suchman, L. A., 1987. *Plans and situated actions: The problem of human-machine communications*. Cambridge, UK: Cambridge University Press.

6. ACKNOWLEDGEMENTS

The Interactive Salon was initiated by the Swedish Forum for Cultural Heritage at the Interactive Institute in cooperation with Stockholm Stadsmuseum (Stockholm City Museum) and the European Network of Excellence in Open Cultural Heritage (EPOCH). It was also funded by Stiftelsen Framtidens Kultur (The Foundation for the Culture of the Future) and Riksbankens jubileumsfond (Bank of Sweden Tercentenary Foundation).

The evaluation of the Interactive Salon is part of an ongoing research project *The museum, the exhibition and the visitors - meaning making in a new arena for learning and communication* funded by the Swedish Research Council and run by Stockholm University. This paper constitutes part of a subproject entitled Museum IT-artefacts.

A DIGITAL EXHIBITION OF THE HISTORY OF THE OLYMPIC GAMES IN ANTIQUITY.

Anastassis A. Katsikas^a, Charalambos G. Venetopoulos^b

^aAthens School of Fine Arts, Postgraduate Program in Digital Arts, 256 Peiraios Street, 182 33
Athens, Greece, (tassosk@asfa.gr)

^bMinotaur Digital Arts Ltd., 12 Olympiou Diamanti Street, 546 26, Thessaloniki, Greece (babis@mda.gr)

KEYWORDS: Virtual Heritage, 3D reconstruction, Surface Baking, Skeletal Systems, Haptic Technology

ABSTRACT:

The Digital Exhibition of the History of the Olympic Games in Antiquity is a project for the Hellenic Ministry of Culture funded by the 3rd European Framework. We can define this Digital Exhibition as a complete set of digital applications or a “digital bunch”. This digital bunch acts rather complementary to the exhibits of the Ancient Museum of Olympia and presents a complete picture of the Ancient Olympics for the visitor. The Digital Exhibition uses 14 different information systems varying from classical info kiosks and PDAs to Haptic Systems, Synchronized Video Sequences, and Virtual Reality Theater. Although the project makes an extensive use of digital technology, all the applications are separated from the original exhibits of the Museum, in order to respect the classical form of an Archaeological Museum. The production of the content, the digital applications and the system integration took more than 15 months before being presented to the public.

1. INTRODUCTION & GENERAL CONSIDERATIONS

The basic idea of this project was to make more attractive a classical archaeological museum with the appropriate digital technology applications. The museum in the city of Olympia is a neoclassical style building, and was designed and constructed in 1885 by the German architects F.Adler and W. Dorpfeld. The whole construction was funded by the famous Greek philanthropist Andreas Sygros, and for that reason the building was named *Sygreion*. Until 1970 all the famous statues and artifacts of the Olympia excavations were hosted in this building. When the new museum of Olympia opened in 1980 the old one closed and after extensive reconstruction works he opened again in 2004, as the Museum of History of the Olympic Games in Antiquity. During the reconstruction phase of 2002-2004, a lower level was created in order to host future thematic applications. The basement was finally used to host the Digital Exhibition of the History of the Olympic Games in Antiquity. The production of the content, the digital applications as well as architectural works and the system integration took more than 15 months to be presented to the public. The project started in January, 2007, and from last April, 2008 until August, 2008 the museum operates in a pilot process. For the design of the digital exhibition a number of general rules were taken under consideration for the whole design process.

The collection of the exhibits is the most valuable asset of the museum, not only because of its high archaeological value, but also because of the combining force of the assorted messages and information. The entire content of the exhibit illustrates the amazing achievements of the ancient Greek world, which by rituals such as festivities and games, developed social responsibility and the spirit of community.

- The constant bonding between these rituals and the city-state as a way of social and political forming in the ancient world has been greatly illuminated by recent archaeological studies. Based on the plethora of information, the diversity of the visitors, and the functional capabilities of the museum, the digital exhibition will discretely serve the existing ancient exhibits of the ground floor, but also will

act as a complementary repository of information in the lower level.

- While the visitors of the museum have to follow a predefined path in the main rooms of the ground floor of the museum, they are free to select any digital system they wish, when they are on the lower level.
- The content of the digital exhibition will be presented in 4 languages, i.e. Greek, English, French and German.
- For the personal information systems (PDAs), the exhibit descriptions will be presented in two versions. The first “compact” version will be offered to visitors with a limited time for the visit of the museum. This version will focus on the major exhibits of the museum only. The second one will cover all the exhibits of the ground floor of the museum.

2. THE INFORMATION SYSTEMS

The Digital Exhibition of the History of the Olympic Games in Antiquity uses 14 different information systems varying from classical info kiosks and PDAs to Haptic Systems, Interactive Walls, Synchronized Video Sequences, and Virtual Reality Theater. We will focus on some of the most attractive systems of the exhibition, i.e. the Haptic System, the Synchronized Video Displays System, and the Virtual Reality System.

2.1. Haptic System:

The Haptic System is a virtual reality system where the user can interact, through the senses of touch and sight, with digital models of 3D art forms and sculptures [1]. The system (Figure 1) main components are: Host PC, Control Unit and the two Robotic Devices.

- **The Host PC.** The Host PC is the high level application computer responsible for force rendering and graphics management procedures. Also the Host PC communicates the data for controlling the robotic devices to Control Unit through UDP protocol.
- **The Control Unit.** The Control Unit runs Low level control software. The main functionalities of the Control Unit are:

To acquire the HI sensor signal, to generate the correct HI control motors signal for moving two arms and for providing an open loop (pre-compensated) control for exerting forces on the end-effector (force feedback functionality). Other functionalities of the Control Unit are the implementation of the control algorithms of the force to be exerted and position/speed of the end-effector, and the management of the UDP communication with Host PC.

- **Robotic Devices:** The robotic device is made of two identical mechanical arms each having a serial kinematics with a total of 6 degree of freedom. Robotic devices provides the force feedback to the user by means of two suitable thimbles

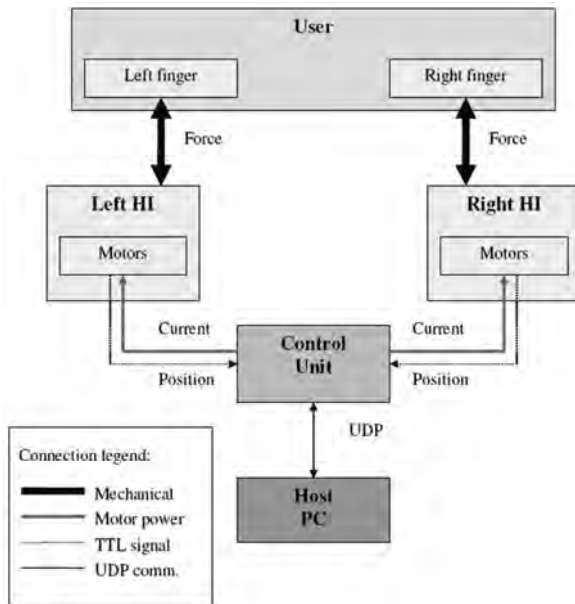

Figure 1: Haptic System diagram

In our case, the system allows to the visitor to “touch” well-known statues with a thematic relevance to the games of antiquity. It should also be emphasized that since these statues are exposed in different museums around Greece, the Haptic System can be considered as a “digital repository” of statues and sculptures. Currently, two famous statues are presented, the well known *Hermes of Praxiteles* and *Eniochos of Delphi*. Both statues were digitized using 3D scanning technology systems and then imported to the graphics engine of the Haptic System (Figure 2). In order to enrich the visual part of the application for the user, a 3D auto-stereoscopic screen is added. The system also allows those individuals with visual disabilities to “touch” digital copies of existing statues, thanks to the extensive use of touch imparted by the system. The Haptic System was developed and installed in the museum by PERCRO research.

2.2. The Virtual Reality System

Although Virtual Archaeology has been accused of being more 'an artistic task than an inferential process', this medium still remains the most attractive approach for digital reconstruction [2]. In this application, a virtual walkthrough of the site of Ancient Olympia is presented with the help of dramatized narration. Our heroes, an old athlete and his grandson, walk in the site of Ancient Olympia in June 169 B.C.



Figure 2: 3D model of the *Eniochos of Delphi* statue.

In 22 minutes, the athlete presents detailed information about the various buildings and temples of the site. His grandson is attracted by the story and by the site and he decides to be an athlete for his city-state when he grows up. The scenario is based on the book of Pausanias *Guide to Greece* [3]. For the construction of the 3D models, our main bibliographical reference was the 5 text volumes and the drawings of the German Archaeological School, *Olympia. Die Ergebnisse der von Deutschen Reich veranstalteten Ausgrabung* (Adler et al. (1892-1897))[4],[5],[6]. In total, 29 buildings were digitally reconstructed, each in 3 different versions, i.e. High, Medium and Low Quality models, or 40K, 10K, and 1K polygons (Figures 3, 4, 5). By using videogame techniques, each High Quality model was “equipped” with the appropriate textures. Then all the textures were “baked” using the appropriate lighting conditions. Finally, all the baked textures from the High Quality 3D models were ported to the Low Quality ones. The advantage of this approach is the cinematic quality of textures for a Low Polygon Model. In total, 2,848 baked textures were created for the 29 different buildings of the site. The show is presented to 27 visitors each time, using two video projectors on a screen with dimensions 4m x 2.5m. Each visitor uses his/her own stereo-glasses and headsets. The system supports 4 languages (Greek, English, French, and German) and each visitor can select his/her own language. The system also allows to the viewers to “vote” and select between various paths through the buildings of ancient Olympia.



Figure 3: Philippeion 3D Model



Figure 4: Epidamnos Treasure 3D model



Figure 5: Anonymous Treasure 3D model

2.3. The Synchronized Video Displays System

A corridor with 5 successive video displays on each side serves as the entrance to the digital exhibition. On the left, a “walking” video presents the ancient procession from ancient Ilys to Olympia (Figure 5), while on the right side a group of ancient athletes are practicing in the Gymnasium, while others run from screen to screen. Every element of this 2D sequence is a 3D

object placed in a separate layer. A skeletal system is also encapsulated in each element (Figure 6). All the elements move independently for 3 minutes, using their own skeletal systems. The main objective of this application is to “drive” the visitor to the central room of the lower level, where a variety of different information systems is installed.



Figure 5: Synchronized Video Sequence

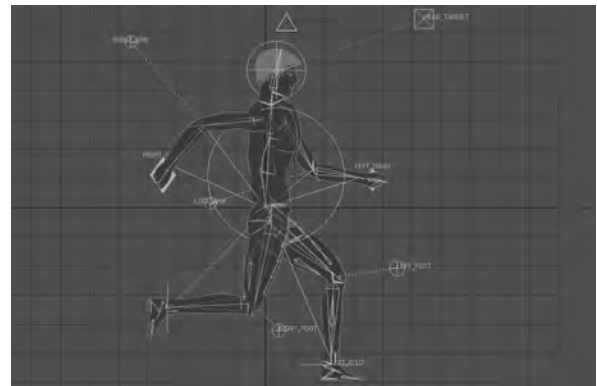

Figure 6: Skeletal System of the 2D Elements

3. CONCLUSIONS/FUTURE DIRECTIONS

For the first time a large number of information systems has been combined for the presentation of a classical museum exhibition such as the History of the Olympic Games in Antiquity, not only in Greece, but also worldwide. Although a wide number of multimedia applications were used, we believe that a symbiotic relationship has been formed between the classical exhibits and the current digital bunch. A number of difficulties during the content creation process and a questionnaire from the visitors of the museum during the pilot operational period helped us to arrive at the following remarks:

- The Haptic System was evaluated as a difficult multimedia system, since the majority of the visitors could not interact with the virtual statues, without some kind of training. In addition, since the models were presented in full scale, many visitors requested that some statues be scaled down in a future version.
- The majority of visitors were attracted by the VR Theater. The comments for the visual approach were very positive. Although 3D sound techniques were used, a few problems have arisen from the matching between the sound data and 3D objects in some languages.

- The lack of live elements (human figures) in the show, which were left out due to budget constraints, rendered the presentation less attractive. This was particularly noted by the young visitors, since they are more familiar with digital culture (videogames).

We hope that future versions will address the above issues and will bring the classical type of archaeological museums into the 21st century.

4. REFERENCES

Haptics Technologies and Cultural Heritage Applications. Bergamasco, M.; Frisoli, A.; Barbagli, F. Computer Animation, 2002. Proceedings of Volume , Issue , 2002 Page(s):25 – 32

About virtual archaeology: disorder, interaction and virtuality. *Virtual reality in Archaeology*. Forte, M. (2000). BAR S843. CD ROM, Archaeopress. Oxford.

Pausanias, (2nd C AD). *Guide to Greece vol 2: Southern Greece* (trans. P. Levi). Penguin Classics, London, 1979.

Adler, F., Curtius, E., Dörpfeld, W., Graef, P., Partsch, J. & Weil, R. (1897). *Olympia I: Topographie und Geschichte*, 1897/1966, Verlag Adolf M. Hakkert, Amsterdam

Adler, R., Borrmann, R., Dörpfeld, W., Graeber, F. & Graef, P. (1892). *Olympia II: Die Baudenkmäler von Olympia*, 1892/1966, Verlag Adolf M. Hakkert, Amsterdam.

Mallwitz, A. (1972). *Olympia und seine Bauten*, Prestel-Verlag, Munich

VIRTUAL SAMBOR PREI KUK: WEAVING THE TANGIBLE AND INTANGIBLE CULTURAL HERITAGE

S. Lam^a, Y. E. Kalay^a, D. Mitchon^b, Y. Perez^a, S. Hong^a

^a Dept. of Architecture, University of California, Berkeley, Room 370 Wurster Hall #1800, Berkeley, CA 94720-1800, USA - (selinalam, kalay, pyael, seungwan)@berkeley.edu

^b Dept. of Department of Philosophy and Religious Studies, Claremont McKenna College, Mills 206, Claremont CA 91711, USA - Daniel.Michon@ClaremontMcKenna.edu

KEY WORDS: Multi User Virtual Environments (MUVE), New Media, Tangible Heritage, Intangible Heritage, Place-making, Hinduism, Temple

ABSTRACT:

Computational modelling of tangible and intangible heritage provides a new media for researching and communicating the genesis and evolution of sites of cultural significance. In particular, Multi User Virtual Environments (MUVEs), allow for digital modelling not only of the tangible heritage (the site and the artefacts), but also the intangible heritage—the people and their activities, which were part of the heritage. This paper illustrates a cultural heritage project which capture and communicate the interplay of context (geography), content (architecture and artefacts) and temporal activity (rituals and everyday life) leading to a MUVE-based reconstruction of Sambor Prei Kuk, the ancient capital of the Khmer empire in 7th Century Cambodia. The MUVE is provides a platform that enables visitors to experience the cultural heritage of SPK as it might have existed 1300 years ago.

1. INTRODUCTION

The Virtual Reconstruction project of the central temple at Sambor Prei Kuk (SPK), the ancient capital of the Khmer empire in Cambodia, is an attempt to apply 21st century technology to 7th century cultural heritage.

Sambor Prei Kuk provides the earliest record of Khmer temples, predating better known (and better preserved) Angkor Wat by several centuries. Hence, the study of SPK is crucial for understanding the Khmer, pre-Angkorian tradition; and the subsequent development of temple cities such as Angkor Wat in Cambodia.

As befitting an important cultural heritage site, SPK has been studied by archaeologists and other scholars for many years. Their work has provided much knowledge about the culture and the period, especially about the eastern expansion of Hinduism along the trade routes from its Indic origins into Southeast Asia—one of the great cultural assimilations in human history. From the fifth century until the sixteenth century, this diasporic interaction created a unique blend of canonical, local, and borrowed cultural and artistic traditions, which can be seen today in the remains of the many temple complexes along the Pacific Rim (Chihara, 1996; Indorf, 2004).

Much of that important work has, so far, remained the exclusive province of researchers, hidden from the general public who might justifiably find it interesting. The advent of immersive, interactive, Web-enabled, Multi User Virtual Environments (MUVEs) has provided us with the opportunity to tell the story of SPK in a way that can help visitors experience this remarkable cultural heritage as it was in the 7th century AD.

MUVEs are a new media vehicle that has the ability to communicate cultural heritage experience in a way that is a cross between filmmaking, video games, and architectural design. Unlike a film, it allows the observer to be an active participant in the experience. Unlike video games, its objective

is to teach, rather than entertain. And unlike architectural design, it models—in addition to the built environment—also the people who inhabited the site, and their rituals.

The project had three goals: (1) to show how a number of new media technologies can be combined to shed new light on the genesis and evolution of pre-angkorian temple architecture along the Pacific Rim; (2) to help researchers, visitors and students to interact with Pacific Rim cultural heritage, through virtual means; (3) introduce new practices for documentation, modelling and communication of cultural heritage.

2. SAMBOR PREI KUK

The Sambor Prei Kuk Temple cluster has been identified as the capital of the kingdom of Īśānapura founded by Īśānavarman (r. 616-635 CE). The Chinese knew this region as Chenla and wrote about it as a unified state. But rather than a unified state, Chenla was in fact a loosely tied together set of polities in constant flux. At times there would be less cohesion, and then under the leadership of particularly strong ruler, such as Īśānavarman I (r. 616-635 CE) or Jayavarman I (r. 657-690 CE), they would come together with the power radiating out of the center, only to separate out again as the power centre either shifted or lost legitimacy. Thus, we see here Stanley Tambiah's notion of pulsating galactic polities functioning in the manner of mandala states. With this political situation, the ritual theatre of the state would play an important role in strengthening the tenuous, shifting bonds between these polities.

The territory under the control of Īśānavarman in the 7th C. CE extended out from the capital at Īśānapura. In the general Sambor region, ten temple complexes - and hundreds of individual temples - have been found in a twenty square

kilometer area.* At the centre of this square are three temple complexes that make up the ritual, political, and social capital of the region. These three complexes are referred to as Sambor Prei Kuk proper (Figure 1).

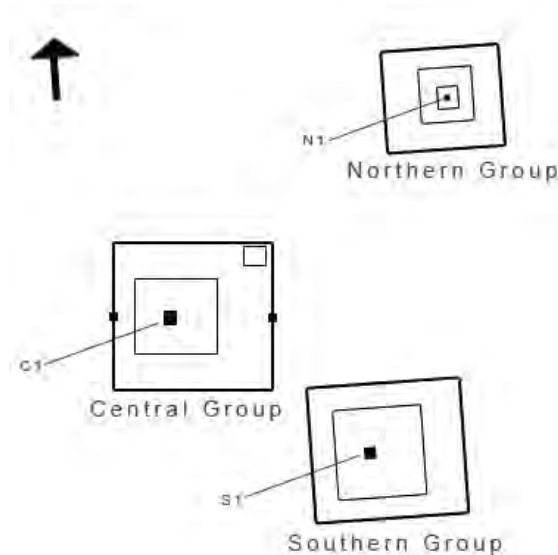

Figure 1: Three major temple clusters in SPK.

The layout, architecture, and sculpture of the three groups of temples at Sambor Prei Kuk would serve as the ritual theatre of the state quite well. It is here that the vision of a cosmic mandala would be instantiated in the land and ruler. There is much evidence that the religious elite practiced Śaivism, and thus at the supra-mundane level Śiva would be the deity at the centre of cosmic mandala, and this would be replicated at the state level with the king as the earthly counterform of Śiva who is the source of power throughout the realm. This is reflected in Īśānavarman's very name: the Sanskrit prefix to his name, *īśāna*, has both political and religious implications as it means "a ruler, master, one of the older names of Śiva-Rudra ... the sun as a form of Śiva."

While many of the temples are in ruin and most of the iconography is now absent (Figure 2), there are sixteen extant inscriptions that have been found at Sambor Prei Kuk. With these clues, we pieced together a provisional picture of what the ritual world at Īśānapura/ Sambor Prei Kuk entailed.



Figure 2: The main shrine of Prasat Tao.

2.1 Modelling the Tangible Heritage

We chose to model only the central group as it was the most simple. It is occupied by a central sanctuary (C1),

"... the cella is large (8.35 x 5.5 m), the walls are divided into panels by pilasters with neither bases nor capitals, and which seem to support the ceiling inserted into a semi-circular hollow created into the whole of the circumference at the top of the walls. Externally the sanctuary rests on a moulded base, interrupted on the four sides by a flight of steps, the string walls of which were decorated with lions." (Dumarçay et al. 2001).

The two lions, indicating the royal nature of the temple, have inspired the most popular name of the temple: the *Prasat Tao*, "Lion Temple." A causeway leads from the central shrine C1 to the inner wall *gopura*, or entrance gateway, straight to the outer wall *gopura*. On either side of the causeway in the inner courtyard, there may have been two smaller structures used as ancillary shrines.** On either side of the causeway in the outer courtyard are two pools that were most likely used for decorative landscaping. In the far northeast corner of the outer courtyard is another pool with steps leading down to it; this pool was most likely used for ritual bathing before performing rituals. Beyond the outermost wall we have chosen to create a market (Figure 3).

* For a general overview of Sambor Prei Kuk and its surrounding region, see Dumarçay and Royère, *Cambodian Architecture*, p. 39-44 and figs. 34-40.

** There are no extant structures there, but the archaeological evidence suggests that two structures did exist. We chose to re-create these two buildings based on the number of shrines in both the northern and southern groups.

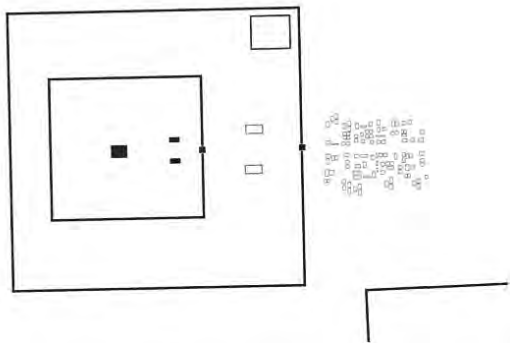

Figure 3: Site plan of the reconstructed Central group.

Our modelling of the site was facilitated by a laser scan, provided by Dr. Takeshi Oishi of the University of Tokyo, in Japan (Figure 4). This technology uses a radar-like device, which shoots a laser ray at the object being scanned, and records the time it has taken the ray to reach its target. The result is a point, defined in 3-dimensional space. Since the device repeats this procedure thousands of times every second, the result is a ‘cloud’ comprising millions of points, which together define the surface of the object. This point cloud is then processed through software to generate a three-dimensional model of the object.



Figure 4: Laser scan and model of Sambor Prei Kuk central shrine.

The site model was developed in 3DStudioMax (a modelling software marketed by Autodesk corp.), and exported to Torque (a game engine made by Garage Games Corp.), which powers our virtual world. Like other similar engines, Torque incorporates a physics engine, whereby ‘gravity’ is imposed, solidity of objects can be enforced, and time of day and weather phenomena can be included. Torque also provides mechanisms to support PCs and NPCs (player characters and non-player characters), which were useful for implementing the actors.

2.2 Modelling the Intangible Heritage

The accuracy of the modelling of the physical environment, the tangible heritage, of the central group is quite secure. As noted

above, there is plenty of evidence from archaeological remains, and any gaps in that knowledge can be filled with confidence by comparing the central group to the northern and southern groups as well as to other contemporary temple complexes within the greater Sambor region. However, modelling the intangible heritage, that is the actions of the inhabitants, is much more speculative. There is very little evidence concerning the type of daily rituals from contemporary Sambor Prei Kuk, therefore, we had to turn to two other sources: (1) inscriptional evidence from 9th -11th c. CE Cambodia, and (2) contemporary Śaivite texts which originated in India in the early medieval period, that is the fourth-ninth century CE, but are extant most often as palm-leaf manuscripts from late medieval, that is tenth-thirteenth century CE, Nepal. In the case of (1) we have the same geographical region but a significant temporal gap, and in the case of (2) we have a similar temporal frame but a significant geographical displacement.

The spatial configuration of the sacred area of the central group at Sambor Prei Kuk suggests the very division of religious ritual which was key to Śaivism’s success. That is, Śaivism maintained a hierarchy of religious ritual that is mirrored in the physical division of the site. The inner courtyard would serve Śaivism at the most élite level. It is here that the royal chaplain (the *rājapurohitā*), on behalf of the king and his court, would perform rituals that would benefit the king personally, but also his household, lineage, and ultimately his whole kingdom. The most powerful ritual, the worship of the Linga alone, would have been centred on the Linga in shrine C1. Outside shrine C1, but still within the inner courtyard, ancillary forms of Śiva would be worshiped in the two small shrines located to the east. These practices would evoke the broader mythological resonances of Śaivism rather than the specific individual and royal concerns addressed at shrine C1. Further, we have chosen to place a particular Śaivite initiation ceremony, the mandala initiation, within the inner courtyard as well. This ceremony would only be for those in the inner circle of Śaivites and would not be on public display, but we chose to include it in the inner courtyard to give visitors an idea of how it might look.

The outer courtyard would serve the “lower” levels of ritual and worship. We chose to model two brahmanical forms of ritual. The first is the fire sacrifice, in Sanskrit *yajña* or *homa*. Here, brahmins would perform more mundane rituals for the health, wealth, and fortune of the common people with full sanction from the ruling class. The second ritual is that of bathing to establish purity. Finally, outside the ritual enclosure altogether there is the non-sacred, profane market.

3. WEAVING THE TANGIBLE AND INTANGIBLE

The convergence of the desire to re-tell the history of SPK and the advent of web-enabled immersive, interactive new media technologies have provided us with the opportunity to develop a new way of experiencing cultural heritage – MUVE (Multi User Virtual Environments). It is based on digital modelling of the site, the people, and the activities that were part of this heritage.

MUVEs are a new media vehicle that has the ability to communicate cultural heritage experience in a way that is a cross between filmmaking, video games, and architectural design. Unlike a film, it allows the observer to be an active participant in the experience. Unlike video games, its objective is to teach, rather than entertain. And unlike architectural

design, it models—in addition to the built environment—also the people who inhabited the site, and their rituals.

But this technology is relatively new, with a short history, devoid of a comprehensive theory, and short on useful precedents to guide the development of virtual cultural heritage experiences. It certainly is a technology of illusion, creating an intangible reality. It freely borrows architectural principles, but can only be experienced through the proxy of avatars. Most importantly (and perhaps disturbingly), it requires filling in of missing details—architectural, social, ritualistic, and others—to create a ‘complete’ experience. Many of these details are based on conjecture and interpretation, informed by thorough research, as explained above. Therefore, we do not claim absolute historical accuracy: instead, we have tried to provide an experience that will convey, as best we can, the sense of ‘being’ at Sambor Prei Kuk in the 7th century AD.

New media reconstructions of historically significant sites, artefacts, and activities bring new opportunities to the practice of preservation and the communication of cultural heritage. Visual verisimilitude, coupled with non-linear storytelling, immersion, and interactivity, affect each aspect of the practice. But their critical implications are not limited to the technical aspects of representation. Rather, new media have the power to transform the practice of cultural heritage preservation and communication wholesale, possibly affecting the meaning of the heritage itself.

The relationship between representational technologies and the cultural heritage they communicate is as ancient as civilization itself. It can be traced back to cave drawings from the upper Paleolithic age, some 40,000 years ago, which supposedly were used to help bring hunts to successful conclusion. The oral epics of Homer and others were used as a social instrument to communicate cultural heritage from one generation to another, only to be replaced by written versions in the form of scrolls, and later by codices, each of which exerted its own influence through the process of remediation: while oral renditions allowed for variations due to the skills of the bard, written forms codified the story, creating an ‘official’ version. The invention of photography early in the 19th century had a particularly strong impact on the representation of cultural heritage. The impact was even more profound with the invention of cinema—a medium able to capture the passage of time itself. The advent of digital game technology—the new medium of remediation—has the potential to affect cultural heritage in even more profound ways than before.

Like the Native American Ghost Dance of the 1890s, which was purported to invoke the return of dead warriors and restore a peaceful past before the advent of white settlers of the American Western plains, new media is a technology that has the power to create world-altering experiences of places and times that are no longer accessible. In many ways they can halt, even reverse the inexorable march of history. But rather than a spiritual belief, new media creates a shareable, participatory experience. It is an imagined, intangible experience, but a real one nonetheless. The image is comprised of a collection of knowledge, methods, technologies, and a culture of preservation, mixed with the interpretive and creative powers of the authors and technicians who wield the storytelling power, and whose own values are implicit in their particular way of rendering the narrative.

The guiding metaphor for such modelling is the concept of *Place*. A “place” is a setting that affords the entire spectrum of human activities, including physical, social, and cultural activities, while affecting, and being affected by those activities. We chose this metaphor to guide our work because it pertains to both physical and non-physical settings. On one hand, place is often used to describe the territory that we occupy. The boundaries of this territory are defined by a sense of being inside—inside a region, a town, a neighbourhood, a building. But that boundary is identified not by a demarcation of its edge, but by the feeling of coherence of the spaces, objects, and activities within it, which give rise to a competence in the way a place is inhabited. We value such places because they give us a feeling of being somewhere as opposed to just *anywhere* (Chastian and Elliott, 1998). The physical attributes of the place frame the activities that ‘take place’ there, and provide its inhabitants with a socially shareable setting for their activities and rituals, in terms of cues that organize and direct social behaviour that is appropriate for that particular place (Harrison and Dourish, 1996).

To help us organize the model, we chose to compare our virtual place-making to a stage-play, which comprises a stage (a context), a narrative (the play), and actors (which include the audience, or visitors, in our case). The notion of place as a stage-play drives literary works, films, video games, and architecture. It provides a framework for understanding the individual contributions of the components, and their mutual interactions. Figure 5 illustrates the components and their relationships.

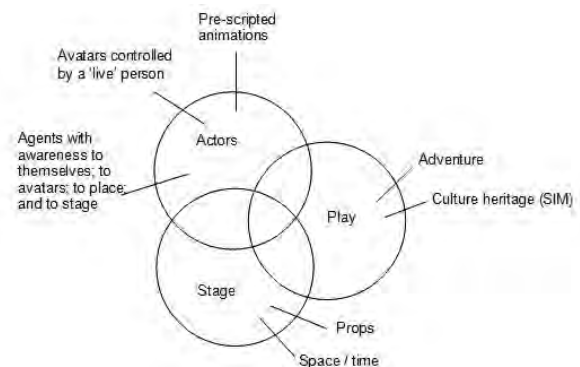

Figure 5: Diagram of the Stage Play metaphor.

The ‘stage’, or context, comprises both space and time. It affords spatial and temporal grounding for the entire model, and includes spatial components like buildings, trees, topography, sky, etc., and ‘props’—objects that can be manipulated by the actors or can act on their own (animals, fire pits, the Linga, etc.). The ‘actors’ include avatars, or PCs (player characters), which are human characters controlled by the people who are logged into the system (the visitors); as well as agents, or NPCs (non-player characters), which are pre-animated, semi-autonomous entities, that perform pre-scripted roles, and sometimes have action modification capabilities based on some sensory input (e.g., they can start some action sequence when an avatar approaches them). The ‘play,’ or narrative, includes both cultural heritage aspects and the activities that take place in the environment (known together as simulation/action). They tell the story (or stories), and afford the freedom to participate in the story.

The interactions between these components are what make them a 'place': the avatars, which are the representations of the visitors, can 'see' other avatars (as well as the other components of the game), and be 'seen' by them. Likewise, the NPCs can be seen by the visitors, and can react to their presence. This reaction both conveys some of the essence of the cultural heritage (they can perform actions related to the history of the place), and add to the authenticity and 'sense of place' of the experience. And of course the context (buildings, marketplace, etc.) help locate the experience, both spatially and temporally.

3.1 The 'Stage'

The first problem facing digital reconstruction of a cultural heritage site is finding the appropriate documentation that describes the built environment and the 'props' for the period being reconstructed. In many cases, some buildings exist. They can be photographed, measured, or digitally scanned, providing a basis for the reconstruction. But much has been obliterated by time and nature.

In the case of SPK, there are some remains in the central temple group, most noticeably, the shrine and the bathing pool. Though there are in ruin, there are other better preserved structures and inscriptions in other clusters that could be referenced. At the same time, as mentioned, laser scan was used to help constructing C1.

3.2 The 'Actors'

The second main challenge in reconstructing SPK was modelling the people who inhabited the site. The physical challenge has been mostly technical: modelling human beings is difficult, because we are so accustomed to seeing them in real life that any discrepancy is immediately, and disturbingly, obvious. Yet, to render high fidelity models of people would slow down the interaction, due to hardware limitations. We needed to develop a wide range of characters, both avatars for the player characters and 'bots' for the non-player characters (the NPCs), who would resemble some of the real people who inhabited SPK in the 7th century AD. We relied on carvings in various temples, including Angkor Wat, and on literary sources that described the people of the region. And we chose to sacrifice some quality in order to gain speed.

3.3 The 'Play'

Finally, the component that brings everything together, is the activity, or narrative. What does the visitor do in the virtual world environment, and how are all those actions and interactions tied together in the larger experience of the virtual world and the story it tells? In the case of SPK, we tried to do this by creating both small, localized activities, centred on various rituals (such as the market, the fire sacrifices, the ceremonial pool, and the Linga ceremony in the central shrine), and the larger, overall narrative, which takes the visitor from outside the temple (the market) all the way into central shrine.

To maintain the 'sense of place,' visitors must choose an avatar (a representation of themselves) that fits the place. Hence, they appear in the scene in the form of one of the people who inhabited the site. Their activity is limited to observing the ongoing activities: they cannot partake in them. But they can chat with one another, via the chat mechanism provided in the game.

4. THE SPK MUVE

The Sambor experience starts with choosing avatars. As mentioned, both the avatars and NPCs resemble some of the real people who inhabited SPK in the 7th century AD. They have Cambodian features. Their hair styles, outfits and decorations are similar to those found from inscriptions and carvings. Visitors can customize the color of their outfit to differentiate themselves from other visitors.

Visitors start their journeys from the market outside the temple.* They would be able to experience the festive side of daily lives (Figure 6), like trades, shows, colorful products in sales, compared to the solemn religious activities experienced later. To enhance the experience, the market journey is accompanied by acoustic effects (sounds of crowds and animals).



Figure 6: View of the market.

Entering the outer courtyard, visitors could join in ritual with NPCs for blessing at the lotus pond, fire sacrifice and ritual bathing. They can participate in the services, but not interfere. If the visitors choose the group mode (via internet connection), they will be able to see and communicate with other visitors who might have logged into the virtual world at the same time (Figure 7).

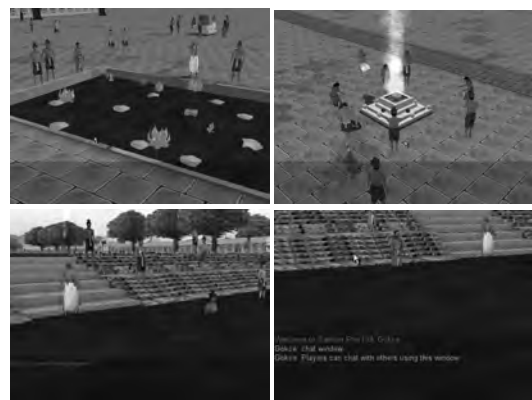

Figure 7: (Upper left) Lotus pond blessing; (upper right) fire sacrifice; (lower left) ritual bathing; (lower right) chat window.

* Whether there was market outside the Temple complex is unknown. The choice of recreating a market right outside the temple walls is mainly to introduce more cultural heritage other than religious practices. The descriptions of the market for the model were taken from the text of early fourteenth century Chinese traveler Zhou Daguan (1987).

Entering the inner courtyard would be of higher level ritual and worship. Visitors would be able to see the main shrine (C1) and two ancillary shrines inside the inner courtyard (Figure 8, left). For the ancillary shrines, as we have no surviving structures but only archaeological evidence for their foundations. Therefore, we were more conservative in their modelling. Using both inscriptional and sculptural evidence from both the northern and southern groups, we can confidently posit that they contained ancillary forms of Śiva. Yet, we have no idea what their form might actually have been. Therefore, we chose to not recreate the interior of these shrines. The visitor can see the outside of the shrines and witness devotees at the entrances, but the visitor cannot enter them.

We have also modelled the ritual of a mandala initiation (Figure 8, right). This would be a ceremony only for those who wished to enter the highest levels of Śaivite initiation, and therefore it would be performed by very few.



Figure 8: Ancillary shrine (left) and mandala initiation (right).

Finally, visitors would reach the main shrine to attend the ritual which was supposed to be reserved for the royal family (Figure 9). There is no clear evidence concerning the details of the ritual performed in the central sanctuary. There is no doubt, however, that a Śiva Linga atop a pedestal was installed at the centre of shrine C1. The size of the shrine suggests that any rituals done here would be private, as perhaps only ten to fifteen people could fit into the shrine itself at one time, and the circumambulation of the Linga would be difficult with even this many bodies present. But, again, there are no inscriptions or documents describing the rituals that were performed there. Therefore, in reconstructing the intangible heritage of the site we have to use imperfect evidence.



Figure 9: Entry to the main shrine (left); worship of the linga inside the main shrine (right).

5. CONCLUSIONS

The project provides means to capture and communicate both intangible and tangible heritage. For whereas new media has already been used successfully to capture and communicate tangible heritage (pictures and models of buildings and artefacts), the intangible aspects of heritage—the people, their activities, and the rituals that gave meaning to the tangible heritage—have largely not been preserved, except in filmic recreations, songs, and stories. Such preservation should be

based on historic evidence as much as possible but will usually require also the best assumptions of professionals in the field to complete the intangible details into a meaningful “picture” presented through new media. The Sambor Prei Kuk project serves as an example of new media’s ability to support the reconstruction and dissemination of both tangible and intangible cultures. A complete reconstruction which includes both aspects of historic life could be extremely useful for educational purposes as well as for creating a comprehensive professional historic debate. Moreover, the cultural heritage content of the research provides the driving problem and a reason for integrating what have so far been (largely) separate areas of research: archaeology, architecture, and new media. Their combination into one project offers visitors a genus loci of the site and its culture, and the *raison d’être* and a direction for combining the three research areas.

6. REFERENCES

- Chandler, David. 1983. *P. A History of Cambodia*. Boulder: Westview Press.
- Chastain T. and A. Elliott, 1998. ‘Cultivating Design Competence: online support for beginning design studio’, *Proceedings of Association for Computer-Aided Design in Architecture (ACADIA)*, T. Seebohm and S. Van Wyk (eds.), Quebec City, Canada, Oct. 22 - 25, 1998.
- Chihara, D., 1996. *Hindu Buddhist Architecture in Southeast Asia*, E.J. Brill, Leiden
- Dumarçay, J., P. Royère and M. Smithies, 2001. *Cambodian Architecture*, p. 43.
- Indorf, P., 2004. Interpreting the Hindu Temple Form: A Model Based on the Core Conceptualization of its Formal Expression of Movement. *The Journal of Asian Art and Archaeology Artibus Asiae* 64 (2):5-.
- Harrison S. and P. Dourish, 1996. ‘Re-place-ing Space: the Roles of Place and Space in Collaborative Systems’, *Proceedings of Conference on Computer-Supported Cooperative Work (CSCW’96)*, Boston, Massachusetts, November 16, 1996, ACM Press, Boston, Massachusetts, 67-76.
- Paris, Pierre. 1941. “L’importance Rituelle du Nord-Est et de ses Applications en Indochine.” *Bulletin de l’Ecole Française d’Extrême-Orient* 41: 303-333.
- Zhou, Daguang. 1987. *The customs of cambodia = zhenla feng tu ji*. Zhenla feng tu ji. Bangkok: Siam Society.

7. ACKNOWLEDGEMENTS

The Virtual Reconstruction Project of Sambor Prei Kuk Temple, Cambodia was realized by the Digital Design Research Group in the Architecture Department at UC Berkeley, headed by Prof. Yehuda Kalay. It has been made possible through the sponsorship of the University of California Pacific Rim Research Program, by the contributions of colleagues at UC Berkeley, Claremont McKenna College, Waseda and Tokyo Universities in Japan, and Deakin University in Australia. We thank them all, as well as Garage Games who allowed us to use their Torque Game Engine to implement the project.

Documenting and Preserving Cultural Heritage for the Web

INTRODUCTION OF ARATTA* AS A COLLABORATIVE RESEARCH TOOL FOR IRANIAN ARCHITECTURAL HISTORY

E. Khazraee^{a,**}, H. Malek^b, H. Forghani^c

^a ICT Dept., Encyclopaedia of Iranian Architectural History, Vali'asr St., Tehran, Iran - khazraee@eiah.org

^b Technical Dept., Sharif FarsiWeb, Inc., Azadi St., Tehran, Iran - hamed@farsiweb.info

^c IT/IS Dept., Canymes Co., Shiraz St., Tehran, Iran – h.forghani@Canymes.ir

KEY WORDS: Semantic Web, Social Tagging, Bibliographic Reference Management, Metadata, DC 'Subject' element Refinements

ABSTRACT:

Aratta is a project being developed as a web-based research tool which allows note taking along with establishment of semantic relations between notes as well as providing reference management services. The idea of Aratta is a combination of social contribution and semantic web concepts. In this project a semantic wiki has been developed to meet the needs of research in the domain of Iranian Architectural History. Aratta deploys a conceptual model for semantic relations which prevents common misunderstandings in Interpretation of Iranian architectural history. The project applies six refinements established based on DC relation element as semantic Meta data.

1. INTRODUCTION

Web in its new vision has introduced a different world in domain of research. The two important aspects of the new web generation are social contribution of different class of users and semantic web abilities. Social contribution has an important role in the development of semantic web as it is an important source of quality data that can be rendered machine processable. Data generated by users should be assumed to represent a great part of the semantic web concept.

In each specific domain of knowledge, experts form an important class of users. For this group of contributors, the new web generation offers new opportunities such as web based tools which can improve team work and more efficient collaboration in knowledge production. The idea of social web and semantic web could be merged to present a research tool for adding a semantic layer to data pieces extracted from different resources to achieve a better resources description. Besides, semantic ambiguity may sometimes happen by transformation of meaning through time. This level of ambiguity could be considerably reduced by adding interpretational tags to the data extracted from old texts. Moreover, providing a proper environment for the experts to tag the resources will improve production of high quality Metadata. This is because if such a system could be able to attract expert users, their contribution could be supposed as human computation for more accurate resources description. This kind of contribution would additionally emerge the hidden side of resources; the meaning lies under the texts. This opportunity would add a real semantic layer to the data on web. This advantage along with good reference management support of data pieces provided in this system could make it an efficient research tool.

Considering basis addressed in the above paragraph, the Aratta project is a web-based research tool which enables users to share their research notes extracted from primary resources, and to tag them for better retrieval. Besides, the semantic relations defined for this tool, would help connecting data pieces from different resources. Moreover, while the notes are well connected, it is supposed that the resources themselves are better described. As a result, a semantic web block will gradually appear in a specific domain of knowledge.

The idea of Aratta came into reality when the need for a web-based environment and its related tools for research in the domain of Iranian architectural history were felt by the architectural studies department of Shahid Beheshti University (SBU). The Aratta project was designed in this case as a web-based research tool for note taking as well as adding semantic data and relations to the notes, while users could share their data and use reference management services as well. Meanwhile, the crucial need of interpretation of old textual resources could be satisfied by Aratta. Passing hundreds of years, the lexical meanings have been considerably transformed; therefore, the understanding of old primary resources today needs interpretation. By Aratta, a hermeneutic layer of data would be accompanied with the old textual resources which could lead to better interpretations.

2. DESIGN, CONCEPT, AND APPROACH

"Social Web is an ecosystem of participation and value is created by the aggregation of many individual user contributions, The Semantic Web is an ecosystem of data, where value is created by the integration of structured data from many sources" (Gruber, 2007 p.1). Based on this idea, merging a social web of experts and semantic web will produce a

* Aratta was a lost civilization in the history which was mentioned in Mesopotamian scripts, due to the new archeological investigation in south-east of Iran. This hypothesis strengthens that Aratta was locate in Jiroft basin in Kerman. One of the most interesting findings is the scripts written on bricks which have not been read yet.

** Corresponding author

synergy in knowledge production. This means a more expanded and thorough resource description.

The basic concept of Aratta project was a web-based collaborative research tool in which expert users can take notes from various resources. In order to develop an efficient research tool, the solution was supposed to cover two important aspects: contribution of researchers and semantic qualities. Contribution of researchers requires:

- A collaborative work space easy to use by different users;
- An easy syntax for note taking;
- Clear definition types;
- Traceable contributions;
- Compatibility with mostly used research standards;
- Message boards for comments and arguments.

Semantic qualities require:

- An easy and clear policy for resource description;
- A basic data model that can be adopted easily and cover different aspects of architectural history;
- A method of description which prevents interpretational prejudgments.*

In order to establish such a work space, a set of important objectives had to be considered as follows:

- Good reference management and citation facilities;
- Interoperable data formats for different systems (generally used standards e.g. DC for relational elements which can be dumb done to be used by other systems);
- Obvious guideline and policy for better meta data entry;
- Concrete concepts as relational elements avoiding prejudgments (i.e. leaving abstract intangible ideas in the form of comments and arguments).

The note taking process in Aratta occurs in four layers; first, extracted data or note itself; second, bibliographic data about the source from which the note is taken; third, a semantic layer added by tags, keywords, descriptions and interpretations; fourth, further comments by other users to prove or refute the interpretations. While the text of notes in the first layer would be searchable and the bibliographic information in the second layer could be searched by the fields, the semantic layer is the basis for erecting a multi-relational model among specified concepts. As a result, this layer would play the key role in the semantic search. Therefore, it would help search engine differentiate most important concepts such as people, buildings, and places.

To achieve an appropriate relational model, Aratta deploys the conceptual model of the Encyclopedia of Iranian Architectural History (EIAH) and defines its relational tags based on this model.

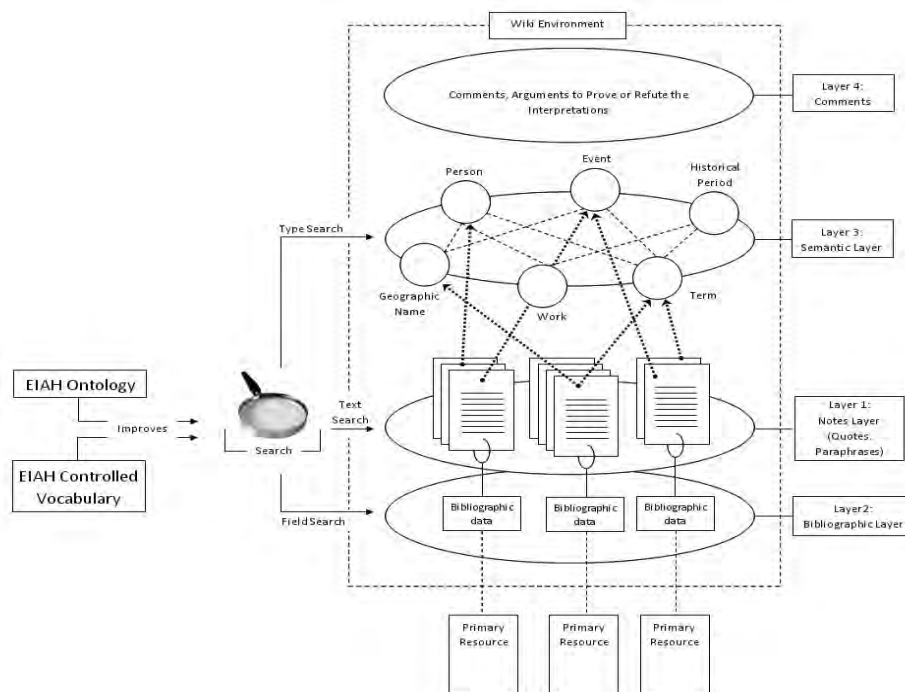

Figure 1: Data model diagram

* Since the history of art and architecture of the Iranian world has been first written by western orientalists, the western established traditions in classification and interpretation sometimes cause misunderstandings in the context of Iranian architecture. This way of interpretation has been the dominant approach in description of architectural works until recently; therefore, this biased point of view should be considered.

The EIAH ontology is now under development, EIAH ontology includes three major classes of entities: temporal, spatial, and human (actors and actions). These are superclasses which are consisted of several subclasses themselves. Each class has abstracts and instances.

Since the major categorization may seem too vague for the end user, the relational tags are classified in six groups which are more tangible: Persons (as subclass of human entities), Works

(monuments and sites) and Geographical Names (as subclass of spatial entities), Historical Periods and Events (as subclass of temporal entities), as well as (Architectural) Terms (which is the abstract level of all classes).

A simple ontology has been designed to correlate the above concepts to the notes. In this way, the whole data (extracted notes) could be searched by latter items and relations.

These relational elements are adopted as refinements of Dublin Core Element, Subject, because they narrow down the subject of the notes. It will help to improve a semantic data in which the notes are being related to the six major concepts. In addition, in dumb down process to simple DC these elements works as keywords of pages and notes. At first look, these relational elements might seem too general, but this major specification would provide users with more accurate search; moreover, these general concepts prevent prejudgments caused by more detailed classifications. In fact, these relational elements play the role of a hidden grid which makes the expert users snap to it (Gruber, 2007 p. 6-8). This approach keeps users in a predefined framework and reduces many of common mistakes. On the other hand, while these relational elements are absolutely concrete concepts, deploying them, different users could describe the data by the least arbitrary judgment.** Meanwhile, in this course aggregation of data and congestion of semantic tags around the instances of the latter concepts would streamline deducting new hypothesis in the interpretation of the old resources and their related data.

For the selected relational elements of Aratta are based on EIAH conceptual model, the development of EIAH ontology would establish more specific semantic relations. Meanwhile, the improvement of EIAH controlled vocabulary could trigger a data aggregation which would connect more data pieces together. In return, the tags accumulated in the Aratta data bank could be used for development of EIAH controlled vocabulary.

3. DATA MODEL AND TECHNICAL ISSUES

Achieving the mentioned objectives, a familiar environment for collaboration has been selected for this purpose, a wiki. MediaWiki software which is the basis of the famous encyclopedia, Wikipedia, was chosen in a survey on the candidate solutions. The reason was that it is open source and widely used. It has high technical contribution globally and compatible with Persian language. MediaWiki also provides the history of changes of each page which make tracing users contributions possible.

Wikis are powerful tools for collaborative work, but they are not enough for semantic tasks and reference management services. Therefore, Semantic MediaWiki (SMW) extension was chosen and adapted to provide reference management services and good semantic description. Semantic wikis help to search, organize, tag, browse, evaluate, and share the wiki's content. While traditional wikis contain only texts which computers can neither understand nor evaluate, Semantic MediaWiki adds semantic annotations that bring the power of the Semantic Web to the wiki. To do so, Semantic MediaWiki

introduces a concept named Property. Properties can be viewed as "categories for values in wiki pages". They are used by a simple mark-up, similar to the syntax of links in MediaWiki. Using Properties all attributes and relations between notes can be defined.

'Subject' Refinements	Description
Related Event	http://eiah.org/en/Entries#Event
	-
Related Geographical Name	http://eiah.org/en/Entries#Geographic_Name
	A proper noun that designates a place.
Related Historical Period	http://eiah.org/en/Entries#Historical_Period
	The historical periods used in EIAH.
Related Person	http://eiah.org/en/Entries#Person
	The name of an individual pertaining to the Iranian architectural and urban history.
Related Term	http://eiah.org/en/Entries#Term
	A technical word or phrase used in the context of Iranian architectural and urban history.
Related Work (monument and site)	http://eiah.org/en/Entries#Work
	A monument, building, historical site, etc. pertaining to the Iranian architectural and urban history, Containing movable ones.

Table 2: DC 'Subject' Refinements 1

For ease of use, the Semantic Form Extension was used to make it syntax free for ordinary users. Also the necessary customizations for Persian language such as right to left script, full Unicode support and Persian calendar are implemented.

In implementation process, at the first stage, two layers were considered: one for reference management which is a collection of bibliographic data of the source of which the note was taken and the other, a semantic layer which was introduced previously. Both layers are consisted of DC elements or refinements, which standardize data exchange (Figure 3). DC elements as, Title, Creator, Contributor, Issued, Location, Type and Abstract were used for reference management. The significant role of DC in data exchange is obvious because there are mappings from and to it by several generally used metadata schemas (Day, 2002). To work with reference management tools the bibliographic layer of Aratta mapped to BibTeX format and it can be exported into BibTeX. Besides, the semantic layer should be mapped to a commonly used semantic model. Since CIDOC/CRM is a well known ontology in the domain of cultural heritage, definition of a mapping to it could be useful. Mapping ontologies to metadata schemas is not a simple procedure (Sowa, 2000). There is a previous work available on mapping DC to CIDOC/CRM (Kakali, et al, 2007). In the latter paper, the methodology of mapping is based on mapping DC paths to the CIDOC paths (chain of entity-property-entity) and it is not a simple crosswalk between DC elements and CIDOC entities (Kakali, et al, 2007 P.132).

** Abstract concepts such as aesthetic and semiotic are sometimes controversial issues, because they are highly depended on the interpreter point of view, therefore, usually it is not easy to reach a general consensus in these contexts.

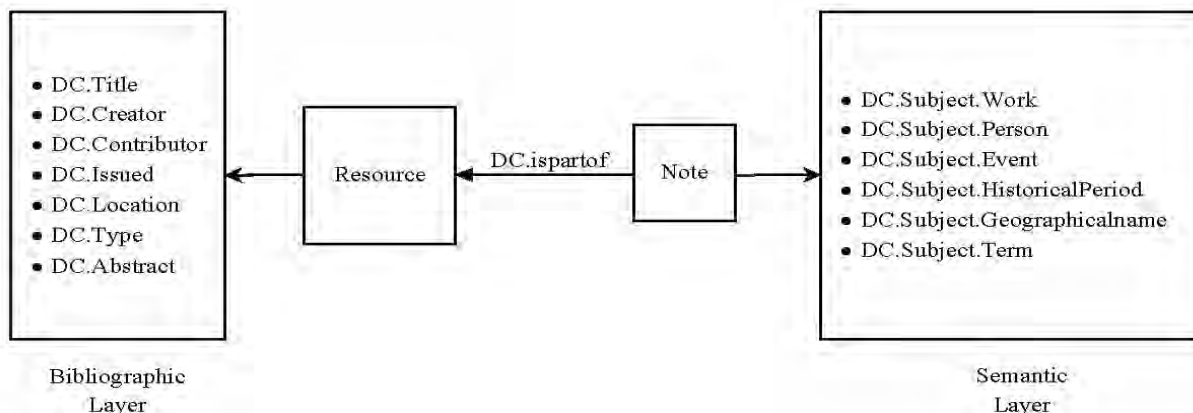

Figure 3: DC elements in semantic and bibliographic layer

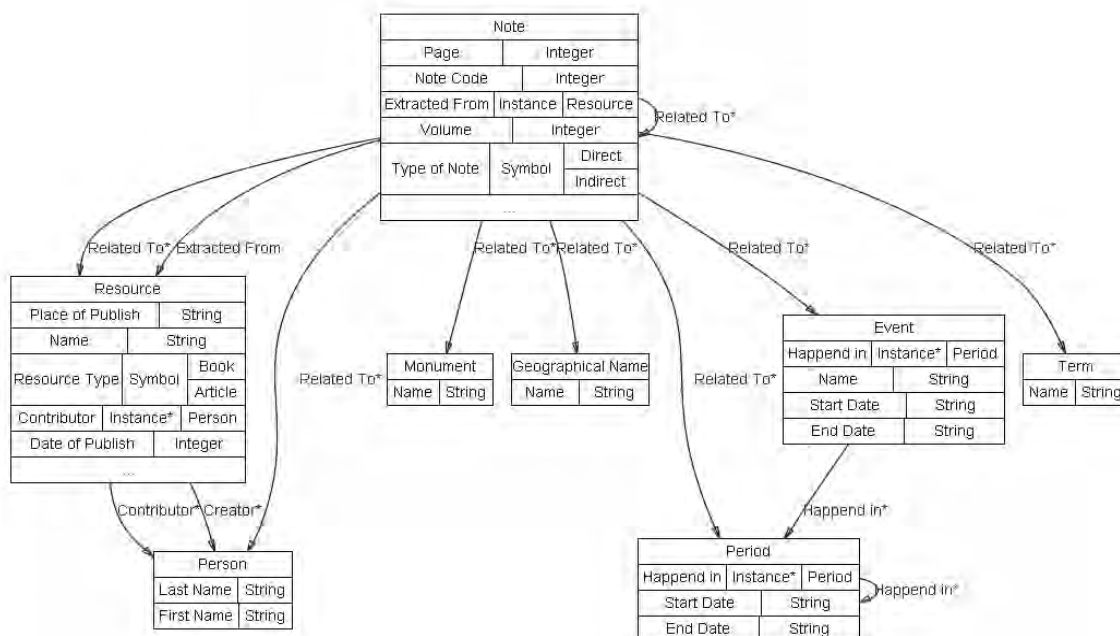

Figure 4: Aratta Ontology

In Aratta project there is a simple crosswalk between its semantic elements and CIDOC/CRM entities. This simple mapping is as follows: Person to E21 Person, Work (monument and site) to E26 Physical Feature, Geographical Name to E53 Place, Historical Period to E4 Period, Event to E5 Event, and Term to E33 Linguistic Object. In future, a more precise mapping will be defined based on EIAH developed ontology to the CIDOC/CRM.

Using Two information layers and storing information based on known semantic web standards also enables us to use external tools for extracting and viewing selected information like using external tools like Timeline or Geographical maps.

To complete the above mentioned process for achieving a homogeneous metadata entry, avoiding undesirable mistakes, and defining accurate semantic relations, a user guideline has been prepared in Persian.

Aratta is now accessible via <http://www.sohrab.eiah.org/aratta> (Fig. 5).

4. FUTURE WORKS

- Deployment of EIAH controlled vocabulary;
- Implementation of more detailed ontology for relation between six major categories;
- Enhancement of usability of tool by adding more features;
- Improving interoperability with other note taking software (e.g. Zotero);
- Implementation of more bibliographical standards;
- Developing a more detailed data model for comments and arguments to let them play a more effective role;
- Developing a mechanism for ranking tags (based on consensus) to add weight to user tags for search enhancement;
- Offline access to data and tools and synchronize system for offline contributions.



Figure 5: Aratta Screenshots

5. CONCLUSION

This project showed that we can use expert contribution in a wiki model as an engine for high quality metadata generation. This merging of social network of an expert community with a simple semantic tool provide a good synergy in resource description and it will help producing controlled vocabulary in a specific domain of knowledge.

6. REFERENCES

References from Books

Kakali, C. et al, 2007. Integreating Dublin Core metadata for cultural heritage collections using ontologies, International conference on Dublin Core & metadata applications proceedings, pp. 128-139

References from websites

CIDOC Documentation Standard Working Group, and CIDOC CRM SIG, 2005. The CIDOC Conceptual Reference Model. <http://cidoc.ics.forth.gr/> (accessed 10 Mar. 2007)

Day, M., 2002. Metadata: Mapping between metadata formats. <http://www.ukoln.ac.uk/metadata/interoperability/> (accessed 31 Jul. 2008)

DCML., 1998. Dublin Core Metadata Element Set, version 1.0: Reference description. <http://www.dublincore.org/documents/1998/09/dces/> (accessed 10 Jan. 2007)

DCML., 2000. Dublin Core Qualifiers. <http://www.dublincore.org/documents/2000/07/11/dcmes-qualifiers/> (accessed 21 Apr. 2007)

EIAH., 2007. EIAH Entry Type. <http://eiah.org/en/Entries/> (accessed 5 Dec. 2007)

Extension: Semantic Forms., 2008. Semantic Form. http://www.mediawiki.org/wiki/Extension:Semantic_Forms (accessed 21 Mar. 2008)

Extension: Semantic MediaWiki., 2008. Semantic Media Wiki. http://www.mediawiki.org/wiki/Extension:Semantic_MediaWiki (accessed 21 Mar. 2008)

Gruber, T., 2007. Collective knowledge systems: Where the Social Web meets the Semantic Web. *Journal of Web Semantics*, 2008, pp. 4-13, Available on <http://www.sciencedirect.com>

OpenOffice Bibliographic Project., 2006. Bibliographic/Software and Standards Information. http://wiki.services.openoffice.org/wiki/Bibliographic/Software_and_Standards_Information. (accessed 2 Feb. 2008)

Sowa, John F., 2000. Ontology, metadata and semiotics. <http://www.jfsowa.com/ontology/ontometa.htm> (accessed 31 Jul. 2008)

Zotero., 2006. Zotero Data Model. http://dev.zotero.org/data_model (accessed 15 Mar. 2007)

AN INTERACTIVE POSTER KIOSK FOR PUBLIC ENGAGEMENT IN CULTURAL HERITAGE DISPLAYS

W. Jabi*, T. Hall

School of Architecture, New Jersey Institute of Technology, USA - wassim.jabi@gmail.com, twhall@twhall.com

KEY WORDS: Museum Applications, Interface Design, Interactive Environments, Interactive Public Displays, Tools for Documentation and Training

ABSTRACT:

This paper describes an application of ubiquitous social computing to support public participation in documenting and communicating the cultural heritage of important sites and artefacts. We have developed an interactive poster kiosk that invites casual feedback on public displays. Posters reside in the system as standard web-pages. Passers-by provide feedback on posters by “finger painting” on a touch-sensitive screen. The system e-mails the feedback to the poster provider. We propose that this system may be effective in supporting a dialog on cultural heritage in museums, archaeological sites, and similar venues. Testing shows that optimum feedback depends on user familiarity with the system and novelty of the posted information.

1. INTRODUCTION

1.1 Motivation

Culture is inseparable from communication, not in a one-way top-down “authoritative” fashion, but rather in a two-way egalitarian fashion. Therefore, it seems reasonable that technology to preserve cultural heritage should support a dialog with the living cultural milieu, lest the heritage be relegated to a dead museum piece, frozen in time, to be observed but not engaged in.

As part of a government funded project in ubiquitous social computing, we have developed and deployed an interactive poster kiosk that engages passers-by to provide feedback on digital posters. We propose that this system may be effective in supporting a dialog on cultural heritage in museums, archaeological sites, and similar venues.

The software runs on standard personal computers and supports large screens and touch-sensitive overlays for public kiosk installations. Posters reside in the system as webpage URIs. The posters are unrestricted in format and may include embedded multimedia content. Passers-by provide feedback by “finger painting” on the touch screen. The system e-mails the feedback to the poster provider.

The software can also run as a desktop application using the standard screen, mouse, and touch pad. As such, it could provide another channel for peer-to-peer collaboration among experts in cultural heritage documentation and restoration.

1.2 Aims

In this context, the interactive poster kiosk aims to engage museum visitors as well as expert peers in exploring and commenting on cultural heritage restoration, preservation, and display.

We originally developed and deployed this system to support design review and feedback in the context of architectural education (Jabi et al., 2008; Hall et al., 2008). Nevertheless, the

poster subject matter is independent of the feedback system. The system is applicable to any domain that invites feedback on posted content.

Many museums provide authoritative information kiosks that allow visitors to stroll through self-guided tours. Each kiosk dictates information on some aspect of heritage, such as an important site, event, custom, or period. Visitor interaction is often limited to pushing buttons that might, for example, repeat the information or augment it by illuminating points on a map or items in an installation. There is generally little or no opportunity for visitor feedback on what they have seen or heard. Did they understand the display? Do they have first-hand knowledge of the topic, perhaps from childhood memories? What aspect of the display did they most “connect” with? Their feedback is constrained to a line in a guestbook, signed on their way out the door.

The interactive poster kiosk aims to improve a museum’s performance as a preserver and conveyer of cultural heritage by inviting more ubiquitous free-form visitor feedback, which might identify weaknesses in presentation, misunderstandings, or even outright errors. Moreover, visitors might be more likely to recall what they have seen if given the opportunity to comment immediately.

1.3 Related Work

Though we implemented the interactive poster kiosk in-house according to our own criteria, we were inspired in part by the “Plasma Poster Network” developed and deployed by Churchill et al. (2003a, 2003b, 2004). Two “factors of success” that they note (2004) are particularly relevant to this application: “low effort to use,” and “means not ends.” The interactive poster kiosk uses a simple graffiti style of annotation over the posted content. The system places no preconditions on the subject, organization, or format of either the posters or the feedback, except that the posters be accessible as web pages.

Other works specifically aimed at computer applications in cultural heritage are complementary to this system:

Baggiani, Colombo, and Del Bimbo (2001) describe an interface for cultural heritage based on computer vision

* Corresponding author.

technology that allows visitors to manipulate large wall displays using their hands as pointing devices. There are many possibilities for the communication that such a system might support. While it might be merely an elaborate means of choosing options from a predetermined menu, it could also support feedback in the style of the interactive poster kiosk. In essence, the kiosk could occupy the entire wall, using the hand tracking system in place of the touch-sensitive overlay. Both interfaces report events to the underlying software as standard mouse events.

Ikeuchi et al. (2004) describe a method of creating digital restorations of cultural assets as they originally appeared, using a pipeline of scanning, registering, and merging images to create texture-mapped geometry. Such models could be exported to VRML or X3D representations and embedded in a web page using a browser plug-in to comprise the content of a poster for the interactive kiosk.

Meyer et al. (2007) describe a web information system for the management and dissemination of cultural heritage data. They focus especially on web-friendly data representations such as HTML, VRML, and SVG. All of these as well as any other media that can be embedded in a web page are potential poster content for the interactive kiosk. Their system and ours serve complementary roles. There is a tool for archaeologists and other experts to access and edit the contents of the cultural heritage database. Ours is a tool for experts to solicit casual feedback from the general public on things such as museum displays or restoration proposals.

2. IMPLEMENTATION

The interactive poster kiosk aims to support freeform annotation of freeform content. The strategy we have adopted is to allow people to submit posters as HTML web pages with minimal restrictions on their structure or layout. A poster may contain live links to multiple pages of content as well as embedded interactive media such as video clips, Flash animations, QuickTimeVR panoramas, or VRML models. When a passer-by chooses to annotate a poster with feedback, the application captures a bitmap “snapshot” of its current state and uses that as the background of a “digital ink” canvas upon which the user can finger-paint. When the feedback is complete, the application e-mails the inked-over bitmap to the person who submitted the poster. Figure 1 shows the kiosk in action. Figure 2 shows an example of the feedback it collected.

To submit a poster, a person finds or creates a web page and submits its URI to the poster administrator. The administrator reviews the submission, and if the content is appropriate, adds the submission to a queue on a web server. The queue is encoded as an XML file comprising a “posterlist” entity with one or more child “poster” entities. The attributes of each poster include the submitter’s “mailto” address (to receive the feedback), the poster URI, and the time in seconds that the application should await user interaction before timing out and proceeding to the next poster in the queue. Figure 3 shows an example of a posterlist XML document.

The application retrieves the poster list from the server at regular intervals and displays the posters in sequence. A user can take unlimited time interacting with a poster, including



Figure 1: The interactive poster kiosk in action.



Figure 2: An example of poster feedback: “Love the Diagrams!”

scrolling, navigating through pages in a series, interacting with embedded multimedia content, or finger-painting feedback. If there is no such interaction for a preset interval (stored as an attribute of the individual poster), the poster times out and the application advances to the next poster in the queue. Whenever it detects interaction, the application resets the idle timer for the current poster.

The bulk of the application display is devoted to the HTML view frame. A vertical strip at the right edge comprises the application control panel. A progress bar indicates the time remaining for the current poster before the system advances to the next poster in the queue. A scrolling list of poster thumbnails allows users to browse and circumvent the normal queue order. An on-screen button initiates user feedback, at which point the system creates a bitmap snapshot, swaps the HTML view with an ink canvas view, and replaces the thumbnails with finger painting tools. When finished, the user touches a “Send” button, at which point the application mails the feedback to the person who submitted the poster and returns to the live HTML view. Figure 4 shows the two modes of the user interface.

```

<?xml version="1.0" encoding="UTF-8"?>
<!DOCTYPE posterlist SYSTEM "http://www.twhall.com/njit/PlasmaPoster/Posterlist.dtd">
<posterlist version="1.0">

  <!-- Introductory "meta posters" about the poster itself. -->
  <poster mailto="wassim.jabi@gmail.com" uri="http://wjabi.net/studio/markmeup/" time="60" />

  <!-- Virtual Systems and MultiMedia Dedicated to Digital Heritage -->
  <!-- QuickTime panoramas -->
  <poster mailto="wassim.jabi@gmail.com" uri="http://www.twhall.com/njit/PlasmaPoster/zaccaria01_qt.htm" time="60" />
  <poster mailto="wassim.jabi@gmail.com" uri="http://www.twhall.com/njit/PlasmaPoster/parthenon01_qt.htm" time="60" />

  <!-- QuickTime videos -->
  <poster mailto="wassim.jabi@gmail.com" uri="http://www.twhall.com/njit/PlasmaPoster/antibes_qt.htm" time="30" />

  <!-- VRML models -->
  <poster mailto="wassim.jabi@gmail.com" uri="http://www.twhall.com/njit/PlasmaPoster/epidaurus_wrl.htm" time="60" />

</posterlist>

```

Figure 3: An example of a posterlist XML document.

The application occupies the full screen (including the area normally reserved to the task bar), exposes no controls for moving, resizing, or minimizing its window, and requires the <Esc> key to exit. After starting the application, the administrator removes the standard mouse and keyboard, restricting user interaction to the touch-sensitive overlay and the application's own on-screen controls. The HTML view exposes no navigation controls other than the thumbnails of approved posters. In particular, there is no text area for entering arbitrary URIs. Navigation is restricted to the set of approved posters

and whatever additional pages they may link to. The administrator must use some care in vetting posters before adding them to the poster list. We discuss other technical and security caveats in more detail elsewhere (Hall et al., 2008).

The kiosk hardware comprises a standard personal computer equipped with a large flat-screen display and a touch-sensitive overlay. The overlay reports touch events to the application as mouse left-button events. (Thus, the application does not "see" or depend on the touch overlay as such. It can run on any PC with a mouse, touch pad, or equivalent input device. For a museum kiosk, the touch overlay provides the most natural interaction.)

There may be any number of kiosks running the application, drawing from the same or different poster lists. The administrator may add or delete URIs in the poster lists asynchronously without interrupting the operation of the kiosks. Each instance of the kiosk application rereads its XML file periodically and updates its poster list accordingly. Since the posters themselves are web pages, authors may revise them at any time.

3. TESTING AND DEPLOYMENT

We have tested the software with a variety of poster content to verify the robustness of the conversion from dynamic web page to ink canvas with feedback. Figures 5, 6, and 7 show examples of feedback on a movie clip, a QuickTimeVR™ panorama, and a VRML model, respectively. An interesting feature of this system when coupled with dynamic interactive content is that the user may provide feedback on alternative views of the content not necessarily considered by the poster author. An example would be navigating through a 3D VRML model to discover an error or an unusual feature from a particular perspective. The user can then freeze the interaction, finger paint over the captured image and send the feedback to the poster author.

The posting and feedback mechanism is independent of the poster context. Though we originally deployed the system to support architectural design review, we anticipate that the lessons learned are transferable to other contexts – such as cultural heritage.

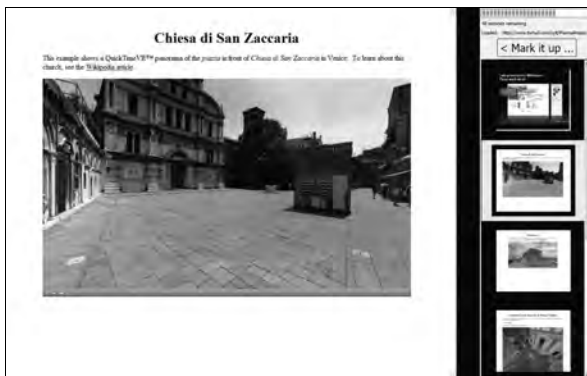

(a)

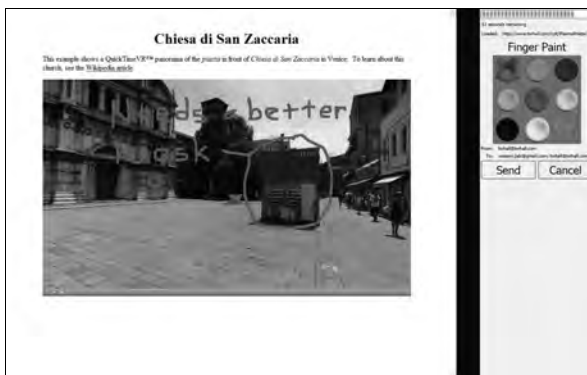

(b)

Figure 4: The two modes of the user interface: (a) the poster as a live web page with other poster thumbnails; (b) the poster as an ink canvas with finger-painting tools.



Figure 5: Feedback on a movie clip.



Figure 6: Feedback on a QuickTime VR™ panomrama.



Figure 7: Feedback on a VRML model.

Our first deployment was at a “research showcase” in the university’s Campus Center. This consisted of demonstrations by one of the authors, as well as “supervised” use by visitors. Following that, we deployed the kiosk in the Architecture Library, unsupervised for a period of three weeks. Excluding tests and demonstrations by the authors, the kiosk attracted a total of 128 feedback events during a four-week period, of which 22 occurred during the showcase and the remaining 106 occurred while unattended in the library. Interaction with the poster passed through three general phases – unfamiliarity, novelty, and familiarity – with the peak interaction occurring during the middle phase.

We reviewed the 128 feedback events and classified 91 of them as some combination of “criticism”, “compliment”, “question”, or “suggestion”. These are not mutually exclusive – many of the events exhibited a combination of elements. The remaining 37 events seemed unclassifiable – for example: illegible, ambiguous, or comprising personal messages. We feared that the anonymity of the feedback might lead to abuse, but were relieved to see very little. The kiosk’s large display and conspicuous situation within the library may have discouraged abuse.

4. CONCLUSIONS

The interactive poster kiosk attracted significant and generally useful feedback during its deployment. Two features of such a system seem particularly important to maintain useful interaction: familiarity, and novelty. Passers-by initially showed some hesitancy in interacting with it. Once they understood its purpose and operation, they were attracted by the novelty of the system perhaps as much as by the posters themselves. When the novelty wore off, the interaction declined.

Visitors need to understand that they’re welcome to interact with the kiosk by touching it. This goes against the etiquette of “look but don’t touch” that normally applies to posters and computer displays. It wants a user interface that’s bold enough to be obvious but subtle enough that it doesn’t detract from the poster content. The allocation of screen real estate and the graphic design of the user interface is itself a design challenge. Priming the system with casual demonstrations helps to spread familiarity.

In a setting with frequent visits by a small number of users, over an extended period, it might be a good strategy to devote the system to exhibiting different themes of information for periods of one or two weeks at most. When there’s no novel content to exhibit for a longer period, it might be a good idea to stow the kiosk to preserve its novelty for its next deployment.

On the other hand, in a setting with infrequent visits by a large number of users – such as a museum – the novelty of the system may dominate.

There are technical challenges in developing and deploying such a system, particularly in regard to security and robustness. Our experience has been positive, and we hope to continue improving the system.

5. REFERENCES

- Baggiani, G., Colombo, C., and Del Bimbo, A., 2001. Advanced Man-Machine Interface for Cultural Heritage. In: *2001 International Conference on Image Processing*, Vol. 1, pp. 582-585. IEEE.
- Churchill, E. F., Nelson, L., and Denoue, L., 2003. Multimedia Fliers: Information Sharing with Digital Community Bulletin Boards. In: *Proceedings of Communities and Technologies 2003*. Kluwer Academic Publishers.
- Churchill, E. F., Nelson, L., Denoue, L., and Girgensohn, A., 2003. The Plasma Poster Network: Posting Multimedia Content in Public Places. In: *Proceedings of Human-Computer Interaction: INTERACT '03*, pp. 599-606. IOS Press.
- Churchill, E. F., Nelson, L., Denoue, L., Helfman, J., and Murphy, P., 2004. Sharing Multimedia Content with Interactive Public Displays: A Case Study. In: *Proceedings of the 2004 Conference on Designing Interactive Systems: Processes, Practices, Methods, and Techniques*, pp. 7-16. ACM Press.
- Hall, T., Jabi, W., Passerini, K., Borcea, C., and Jones, Q., 2008. An Interactive Poster System to Solicit Casual Design Feedback. 28th Conference of the Association for Computer Aided Design in Architecture (ACADIA), Minneapolis, Minnesota, USA, 16-19 October 2008. (Paper accepted; publication forthcoming.)
- Ikeuchi, K., Nakazawa, A., Hasegawa, K., and Ohishi, T., 2004. Representing Cultural Heritage in Digital Forms for VR Systems through Computer Vision Techniques. In: *17th International Conference on Pattern Recognition (ICPR'04)*, Vol. 4, pp. 1-6. IEEE Computer Society.
- Jabi, W., Hall, T., Passerini, K., Borcea, C., and Jones, Q., 2008. Exporting the Studio Model of Learning: Teaming Architecture with Computer Science. 26th Conference on Education and Research in Computer Aided Architectural Design in Europe (eCAADe), Antwerp, Belgium, 17-20 September 2008. (Paper accepted; publication forthcoming.)
- Meyer, É., Grussenmeyer, P., Perrin, J. P., Durand, A., and Drap, P., 2007. A Web Information System for the Management and the Dissemination of Cultural Heritage Data. *Journal of Cultural Heritage*, 8(4), pp. 396-411.

6. ACKNOWLEDGEMENTS

This material is based in part upon work supported by the National Science Foundation IIS - ITR - CreativeIT Division. Grant Number 0714158. Any opinions, findings, and conclusions or recommendations expressed in this material are those of the authors and do not necessarily reflect the views of the National Science Foundation.

WEB SERVICES AND NETWORK TECHNOLOGIES FOR COPYRIGHT PROTECTION AND MANAGEMENT OF DIGITAL HERITAGE

D. K. Tsolis ^a, T. S. Papatheodorou ^a

^a Department of Computer Engineering and Informatics, University of Patras, 26504, Patras, Greece –
(dkt, tsp)@hpclab.ceid.upatras.gr

KEY WORDS: Copyright protection, digital rights management, watermarking, usable user interfaces, web services, metadata, licensing, network technologies

ABSTRACT:

The paper focuses on the implementation of an advanced system which supported by web services and network technologies offers copyright protection and management of digital cultural content. The main components of this Digital Rights Management system are a digital image library, which offers specialized services for storing and searching through peer to peer networks and a copyright protection and digital rights management subsystem for the digitized media based on innovative watermarking and web technologies. The result is an effective DRM system that plays the role of an integrated platform for the storage and management of the digital cultural content, the metadata and most of all for the copyright protection via digital watermarking.

1. INTRODUCTION

1.1 Aims

The cultural organizations are currently trying to adopt to new technologies mainly towards the direction of creating and providing wide access to digital cultural content aiming at having a key role to the digital content industry and to increase the actual visitors. Nevertheless, wide access and delivery of valuable content through information systems raise several critical issues, pertaining to management, protection and exploitation of digitized cultural content [House, 98]. These include at first the critical problem of IPR (Intellectual Property Rights), protection and the unauthorized use and exploitation of digital data (“electronic theft”) and secondly the creation and use of appropriate e-commerce web services which take into account the special characteristics of cultural content.

1.2 Overview

The general objective is:

“Cultural organizations, museums, libraries and archives are currently trying to adopt to the Information and Communication Technologies mainly towards four directions, a) the improvement of their internal work-flows through digitization and advanced content management, b) digital rights management and copyright protection for the produced cultural content c) provision of wide access to the digital cultural content via the Internet aiming at the increase of the actual visitors and d) the direct commercial exploitation of the digital cultural content using e-commerce technologies and services. The objective is to design and implement a system which supports these organizations to achieve the aforementioned goals”.

The majority of information systems in the Cultural Heritage sector are mainly concentrated to the commercial exploitation of digital images. At the same time, some prevailing examples of copyright infringement especially for digital images of Cultural Heritage could be viewed in many corporate web sites, where the unauthorized commercial exploitation of digital images is conducted in an everyday basis. This improper

exploitation of digital images, through these information systems, is proving the lack of awareness of copyright laws for both content holders and content users.

2. MAIN BODY

2.1 Information Systems Development

In this section the information system’s design and development is being presented in detail. During the information system’s implementation, specific technological solutions were applied and exhaustively tested (e.g. watermarking) so as the technical and functional requirements to be fulfilled.

2.2 A Design Overview

The cultural information system is designed based on the requirements and technical specifications which were defined in the previous section. The system:

1. Provides an appropriate infrastructure for the production, protection and distribution of digital cultural content, especially focusing on digital images and its special characteristics.
2. Implements a Digital Image Library and the accompanying search, access and management services.
 - Provides cultural organizations with user interfaces and tools for digitization, management and long term preservation of the cultural digital content and its metadata.
3. Protects the copyright of the digital images through robust watermarking techniques. Multi-bit watermarks are embedded to the digital images which are commercially exploited and delivered to the buyers.
4. Supports the digital rights management process for the cultural content and for the transactions taking place.
5. Provides an effective mechanism for tracking down improper use of digital images which are owned by the cultural organization.
6. E-commerce services and applications implemented range from typical e-commerce applications (electronic catalogs

and shopping kart) to advanced services such as searching for images based on the image content and detection of unauthorized content use.

The general system's architecture and its main components are the following: The Digital Image Library.

- The copyright protection subsystem, which protects digital content with watermarking techniques and provides for digital rights management.
- The E-Commerce applications.

2.3 Digital Image Repository

The design and implementation of the Digital Image Library is required for further development of the information system. The Digital Image Library is consisting of the Image Repository and the Metadata sets which are described in detail.

2.3.1 Image Repository: The efficient management of digital images is based on an advanced database system. The design and development of the Digital Image Library for this platform is an important and quite complicated task.

The Digital Image Library is designed and developed in accordance with metadata sets described in the following paragraph. The metadata sets are incorporated through tables, fields, triggers and views in the Database. The specific tables and fields, which are used for the image library, were selected on the basis of the next requirements:

- Custom metadata of the cultural organization.
- International metadata for the dissemination of culture.
- The international standards for describing, characterizing and identifying digital images.
- The international standards for managing and storing in the long-term data produced by the e-commerce transactions.
- The international standards for managing and protecting the Intellectual Property Rights.

The software instruments selected for the development of the Digital Image Library are the IBM DB2 Universal Database, with the assistance of the IBM DB2 XML and AIV Extenders. The specific system provides advanced services for searching and retrieving digital images according to their actual content. For example it supports digital image retrieval using similarity criteria like colour, histogram, shape etc. In this case the user can use a colour specification or even the image itself as a query to the image library.

2.3.2 Metadata: The need for adopting international metadata standards is profound, especially for applications aiming at cultural content exchange. The DIG 35 Specification "Metadata for Digital Images", Version 1.1 [DIG35, 00] holds a very important role in the selection of fields and tables, regarding the digital images metadata. This metadata standard is already being widely used in simple end-user devices and even to worldwide networks. The database structure has also a special focus on metadata for the Intellectual Property Rights management. In particular, these sets were divided in six major sectors:

- Technical metadata. Technical metadata are related to the image parameters, such as the image format, image size, compression method, and colour information.

- Image creation metadata. The image creation metadata include general information concerning the creation of the digital image. This information involves the time and date of creation, the name of the creator, and information about the capturing device.
- History metadata. The history metadata are necessary so as to identify and record the processing steps that might have been applied to a digital surrogate. This may help to avoid any further processing steps, and to identify independent objects in a composition of digital pictures. This set of metadata contains information on whether or not a digital image is cropped, rotated, retouched, or suffered a colour adjustment.
- Content description metadata. The content description metadata contain descriptive information about the location, the capture time and date, etc.
- E-commerce related metadata related to the transactions taken place by the Internet user with the information system. These data include all the necessary information which describes a transaction such as, transaction ids, user profiling data, dates, amounts, special terms and conditions etc.
- IPR related metadata. This important metadata set is related with the intellectual property rights and involves information about the copyright, the image creator and rights holder, the restriction of use and contact points.

Amongst the various metadata standardization initiatives, Dublin Core (DC) [Dublin Core, 00] has gained significant visibility and respect. Dublin Core is a metadata standard fully applied to cultural heritage and supports the diversity, convergence and interoperability of digital cultural objects. The basic Dublin Core data model is a simple content description model, defined by its 15 elements. The need for incorporating the DC elements in the digital image library is significant mainly because many cultural organizations are already using the DC model and this will support the wider interoperability of the system.

The most common practice of efficiently combining two or more metadata standards is mapping. Mapping between metadata formats requires the creation of a mapping table. The advantage is that this mapping makes it possible for both simple DC-based as well as more detailed DIG 35 (Digital Imaging Group) content-based search to be done. The main difficulty of mapping DIG 35 to DC is the difference of granularity. The DC element set has only 15 elements and on the other hand DIG 35 is a highly structured and detailed metadata set. The mapping table of the two standards was developed. In addition a mapping table was developed between the custom made metadata set of the cultural organization and the Dig 35 correspondent set. The final result was an extended metadata set with a specialized structure capable of producing the metadata information according to the desired level of detail.

2.3.3 User Interfaces and Tools for Digital Content Management:

The Digital Image Library provides also user interfaces and tools which assist cultural organization to digitize, store and manage digital content and the aforementioned accompanying metadata. The tools are implemented using web services technologies and taking into account international usability standards and guidelines. The next figure presents the tool for digitization and metadata management.



Figure 1: Digitization and Metadata Management Tool

2.4 Copyright protection

The copyright protection subsystem is an intermediate layer between the e-commerce applications and the digital image library. Its main function is to protect the copyright of the digital images stored and exploited by the information system. Using a simplified view of the subsystem, it is considered as a black box which takes the original digital images as an input and produces the watermarked images. The whole process is automated and whenever a new original image is stored to the digital library the watermarked surrogates are being created which carry the copyright owner id and other information used for copy control, digital signature, unauthorized use tracking and transaction management.

2.4.1 Watermarking Algorithm: Watermarking principles are mainly used whenever copyright protection of digital content is required and the cover-data is available to parties who are aware of the existence of the hidden data and may have an interest removing it [Cox, 02]. In this framework the most popular and demanding application of watermarking is to give proof of ownership of digital data by embedding copyright statements. For this kind of application the embedded information should be robust against manipulations that may attempt to remove it. Many watermarking schemes show weaknesses in a number of attacks and specifically those causing desynchronization which is a very efficient tool against most marking techniques [Katzenbeisser, 00]. This leads to the suggestion that detection, rather than embedding, is the core problem of digital watermarking [Wayner, 02].

According to the above the first most important step towards the implementation of the watermarking algorithm is the selection and evaluation of the watermarking method. The method chosen is mainly based on the further elaboration of the MCWG (The Multimedia Coding and Watermarking Group, <http://www.mcwg.gr>) watermarking tool, focusing on constructing a more efficient detection mechanism, resulting to a more robust watermarking technique. The core of the MCWG tool is a transform domain technique that is based on the use of the Subband DCT transform [Fotopoulos, 00]. The marking formula is the same well known multiplicative rule used in the large majority of the existing literature. The tool has performed positively in the past in a large variety of attacks, including those that an application like Ulysses would require. It did not though provide support for geometrical attacks. Thus some improvements were considered necessary.

There were two main directions for improvement. The first one was to maximize the detector's performance. As known from the literature, in the case of such systems, the detector's output is a function of two parameters that have to do with the selection of the marked coefficients vector: size and length. An adaptive algorithm has been designed and included into the system that fine-tunes the selection of these parameters [Fotopoulos, 02]. The results of this improvement are clearly beneficial to the system. The other improvement direction has to do with the geometrical attacks problem. A supplement to the system was created based on the notion of the centre of mass. This familiar term from the classical physics theory has been introduced in the image domain by carefully selecting two different logical representations of the image array [Skodras, 02]. Extensive tests performed on images that were rotated, scaled and changed by means of aspect ratio, have proved that those changes can be satisfactory restored, thus providing a positive response from the re-synchronized system. This extension was also included into the original watermarking method.

The proposed watermarking method was tested particularly with digital images provided by cultural organizations all over Greece and fine-tuned in accordance with the produced results. In addition, certain actions were taken for the further development of the method so as to incorporate multi-file support, monochrome and colour images and multidimensional digital images.

2.4.2 Integration Strategy: By integration strategy we mean the methodology followed and the decisions made during the incorporation of the watermark embedding and detection procedure to the information system. The strategy adopted considers the watermarking method that was previously described, as a "black box".

The technical requirement in favour of this implementation is the re-usable format (Software Development Kit and Dynamic Link Libraries) provided for the watermarking method, appropriate for a wide variety of software developments. The watermarking is considered as a generic class, with specific attributes, functions, arguments, parameters and return values. The advantage of this strategy is that the watermarking method is independent from the development of the basic infrastructure (e.g. the Digital Image Library) and the user interfaces.

2.4.3 Implementation: The API (Application Protocol Interface) supporting the Watermarking component is consisting of two significant methods. A method called "embed" is responsible for the watermark casting and the corresponding method called "detect" is capable of detecting the watermark, provided of course that the image is indeed watermarked. The specified API proved to be very handy during the development of the information system, mainly because its structure as an independent DLL (Dynamic Link Library) component, universally applicable by just referencing the corresponding class.

Embedding

One of the most important aspects of the system is its ability to preprocess the digital image and preserve some valuable supplementary information in the database. The association between the digital image and the supplementary information is accomplished through an integer value called imageid, acting as a foreign key for the supplementary information database table. The watermarking algorithm has the responsibility of

connecting to the database and storing the supplementary information, acquired from the image preprocessing, always associated with the actual image through the imageid. The best way to demonstrate how the embedding method works is to present the next figure:

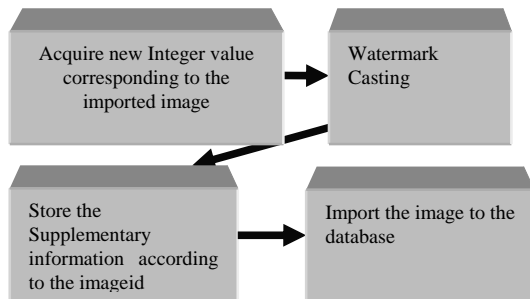

Figure 2: Watermark Embedding

The special reference on this particular system function is justified by the significance of the supplementary information to the process of image registration and consequently, robustness against geometrical attacks during the detection process.

Detection

The main weakness of the majority of the watermarking detection mechanisms is their inability to counter the attacks involving the desynchronization of the detector. Geometrical attacks are a small but important subset of this kind of attacks. The best countermeasure against the desynchronization attacks is definitely the notion of “image registration”.

Image registration is the procedure of finding the exact image instance during the watermark casting. Finding the right instance and providing it to the detector helps the mechanism to achieve synchronization and detect the watermark. However, finding the appropriate instance, without further information available, is not a straightforward task. In the trivial case, the necessary additional information is the original image. This is mainly the reason why the non blind detectors (the original image is in the detector’s disposal) perform better than blind detectors (only the watermarked image is available).

The presence of a digital library and specifically of a DBMS (Database Management System) with advanced search capabilities provided the basis for a more efficient detection mechanism through the cooperation of the image database with the watermarking technique. The detector is initially provided with a digital image in order to decide whether it is watermarked or not. If the first attempt to find the watermark is unsuccessful the detector must try to register the image hoping to find its synchronization and detect the watermark. At this point the original image is essential for the detector. Although, our system has access to a large number of digital images stored in the database, it is impossible to decide which image corresponds to the original copy of the image in the detector. This is where the advanced search capabilities take over and in particular the Image Extender of DB2 Universal Database Management System.

DB2 Image extender is a tool that allows the storage of and query of image data with the same convenience as with traditional ones. The prominent feature of Image extenders is

the functionality of querying images, based on related business data or by image attributes. The entire image database search can be based on data that the user maintains, such as name, number and description, or by data that the DB2 Image Extender maintains, such as the format of the image, its distribution of colours, the illustrated shapes etc. The QBIC (Query By Image Content) queries is the solution to the problem of selecting the correct original image.

Just before the initialisation of the detection process a QBIC query is constructed based on the image under examination. The query response is a similarity measure reporting the probability that the original copy of the image under examination is the one indicated by the image extender. If the probability is high enough, the detector continues the detection procedure having access not only to the original image but also to the supplementary information derived from the image preprocessing. The association between the original image and the supplementary information is conducted through an integer value returned by the QBIC query, which corresponds to the foreign key of the corresponding database table.

2.4.4 Copyright Protection with the Watermarking Algorithm:

Securing the digital content is of a great concern for the proposed information system.

The reasonable approach would be to adopt a strategy of securing the content by guarding it. By guarding we mean the establishment of complicated mechanisms difficult to overcome without proper authorization. Encryption and user authentication are some of the techniques used to forbid access of the digital content. Nevertheless, in circumstances where the adversary succeeds in circumventing the guarding mechanisms, the content is totally unprotected and vulnerable to illegal manipulation. On the contrary, the security provided by watermarking techniques relies on the content itself. Thus, protection continues even after the adversary has managed to obtain the Digital Image Library’s content. In the proposed information system the watermarking algorithm, which was described, is used to facilitate important security tasks over the content. The main tasks are copyright protection by copy control and owner identification, digital signature and transaction tracking.

The enforcement of the aforementioned security measures is based on the notion of the watermark key. The usage and administration of the watermark key is what differentiates the form of security applied, resulting in different cases. The basic principle of every watermarking scheme is that in order for the detection to be successful, the key used by the detector should match the one used by the embedding mechanism. The selection of any different key must cause the detector to fail. An important detail concerning the detector’s output is the value returned. In the trivial case the returned value is a simple indication deciding for the watermark’s existence (Yes / No Boolean response). Under different circumstances it is useful for the detector to return an integer value. This value will serve as a pointer to a useful piece of information regarding the digital object. The watermark key administration, which is implemented into the information system, will be described in the following scenarios.

The copyright protection scenario is the most important one. This is based on two cases, the owner identification and copy control.

In the owner identification case the image owner casts a watermark to the image using a private key. The scenario begins with a dispute between the image owner and an adversary. They both claim ownership of the digital image and they are both asked to give proof of their assertion. The copyright owner with the correct key value in his disposal can prove his assertion by feeding the key to the detector and confirming the watermark's presence. On the contrary, the fake claimer is unable to prove his ownership since his not aware of the correct key value.

Copy control is performed in a quite similar way. The Digital Image Library administrator watermarks every digital image of the library with a constant well known key, before the content distribution takes place. This key is the declaration of the "never copy" instruction. Additionally, compliant devices are equipped with the detector of the watermarking mechanism along with the well know key. Upon the arrival of the watermarked digital image to the compliant device, the detector performs a watermarking detection. In case of positive response the compliant device understands the "never copy" instruction and forbids the replication of the image. This example illustrates the necessity of the device requirement to carry an incorporated detection mechanism, which is a quite ambitious expectation since the watermark detector essentially degrades the device functionality. Only law enforcement will make the above scenario appear as a realistic situation.

Consequently, the requirements of the copyright protection application of the digital library's security, are restricted to the casting of two watermarks, the first using the copyright owner's private key declaring his ownership, and the second using the well know constant key declaring the "never copy" instruction. The next scenario concerns the digital signature security application and describes how the database administrator can discover an intruder trying to populate the database with malicious data. In digital image libraries of maximum importance and security the group of people authorized to contribute information is limited and well defined. The library administrator responsible for the validity of the content should maintain a record correlating a watermark key with the contributor's identification information. These keys are secretly distributed to the trusted party so as each authorized contributor should obtain a unique private key. When someone wishes to store information in the digital library, he sends the information along with his identification to the library administrator, only after he had watermarked the image using his private key. The image library administrator looks through his record and obtains the key related to the identity information provided by the unknown contributor. In case of positive response the administrator proceeds on storing the information to the library, in any other case the data are thrown away. In this way only the authorized group of people is permitted to contribute information to the digital library. The requirements of the digital signature security application are only one watermark per digital image and a Boolean response by the detector.

Finally the last scenario illustrates the transaction tracking security application, where the head of digital image library's security has the duty of tracking and capturing the information leak. As in the previous case this security application is applied in situations where the digital library content is very important and confidential. Once again the security administrator needs to maintain a record with numbers and names. The difference from the previous application is that now, no identity information is provided with the digital image, thus the security

administrator has no way of knowing the correct key for the detection. The solution to this problem is the combination of a constant well-known key for the watermark casting, with a numerical detector's response allowing the correlation of the digital image with its original source. Just before the security administrator distributes the information to the authorized recipients, for example when a buyer is purchasing digital images from the information system, a watermark is embedded using the constant key. If a confidential image or document is found in the wrong hands, the security administrator can initialize the watermark detection process using always the constant key. The detector will result in a number indicating the original source of the image, likely responsible for the leak.

Summarizing the key requirements for the security purposes, every digital image included in the Digital Image Library should contain a key for the owner identification application, a key for the copy control and a key representing the digital signature, all combined with a Boolean detector response. The last key requires a numerical output by the detector and refers to the transaction tracking application of the information system.

The proposed information system raises two basic issues concerning the watermarking technique. The first one is related with the data payload embedded into the image and the second with the detector ability to detect multiple watermarks. Data payload refers to the number of bits a watermark encodes within a unit of time or within a digital object. For a photograph, the data payload would refer to the number of bits encoded within the image.

The drawback in encoding a substantial number of bits into the image is the distortion introduced comparing to the original image. In our case the proposed watermark key administration requires three zero-bit watermarks (the detector's output is either one or zero) and one 14-bit watermark encoding 16384 different fingerprints. Mainly due to the inherent resilience of the DCT-domain technique [Barni, 98] the distortion introduced by the encoding of 17 bits is imperceptible as indicated by the calculated PSNR (Peak signal to noise ratio) value presented in the evaluation paragraph. By multiple watermarks we refer to the detector's potential of detecting a small amount of different watermarks into the same image without confusion. As in the previous case, in the proposed information system the watermark algorithm's inherent capability solves the problem by maximizing the detector's output sufficiently above the selected threshold when the key is valid and minimizing it below the threshold in case of an irrelevant key value. The following graph (Figure 3) demonstrates this feature.

The detector used in the proposed information system reveals the existence of 11 watermarks. Three of them correspond to the three zero-bit schemes while the rest 8 positive responses are used for the encoding of the fingerprint. The detector has succeeded in detecting all eleven watermarks without any confusion or misleading, resulting in a capability of facilitating proof of ownership, copy control, digital signature and transaction tracking at the same time.

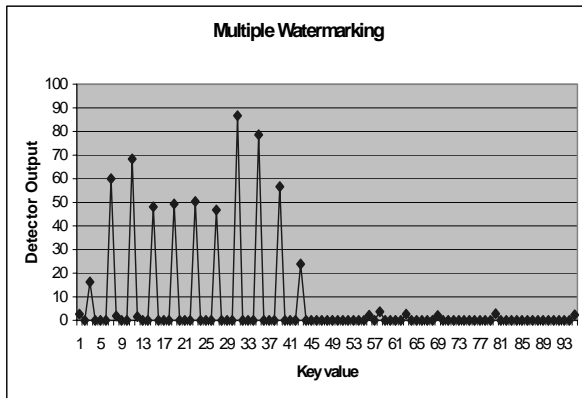

Figure 3: 11 Distinct Watermarks Detected

3. CONCLUSIONS

Designing and implementing an integrated information system for digital rights management and protection, providing at the same time e-commerce services, for a cultural organization is a demanding and complicated task.

Through out our case study, most of effort was dedicated to meet the functional and technical requirements and to deal with the lack of basic infrastructure as far as the copyright protection and management is concerned. The result was a powerful information system that plays the role of an integrated platform for the storage and management of the digital images, their metadata and most of all for the copyright protection via digital watermarking. The watermarking method was further elaborated mainly towards a more powerful detection method and reconstructed as a portable and reusable Dynamic Link Library. The main contributions of this scheme is the ability of proving that a random watermarked image, probably downloaded through the Internet, corresponds to a specific image stored in the information system. Consequently, a) it is proved that the cultural organization is the copyright owner of the specific image and b) the corresponding key for retrieving all the copyright related information (copyright plate, important dates, contact points, etc.) is now available.

Based on the above, in order to optimize the function, interoperability and openness of the information system some services should be re-engineered, with the use of web technologies. The research will focus mainly on re-engineering the digital watermarking process, for the copyright protected images, by using XML Web Services. Specifically, the robust, multi-bit digital image watermarking facility will be encapsulated in a Web Service, allowing its reuse by several components of the information system primarily for signing and identifying copyright protected images.

4. REFERENCES

- Barni M., Bartolini F., Cappellini V., A. Piva, 1998. A DCT-domain system for robust image watermarking, *Signal Processing*, "Special Issue on Watermarking", (66) 3, pp. 357-372.
- Cox Ingemar J., Miller Matthew L. and Bloom Jeffrey A. 2002, *Digital Watermarking*. Morgan Kaufmann Publishers.
- Digital Imaging Group, 2000. *DIG35 Specification - Metadata for Digital Images*. Version 1.0..
- Fotopoulos V., Skodras A. N., A 2000, Subband DCT Approach to Image Watermarking. (5-8 September 2000). Tampere, Finland: X European Signal Processing Conference (EUSIPCO-2000).
- Fotopoulos V., Skodras A. N., 2002a, Adaptive Coefficients Selection for Transform Domain Watermarking. *Technical Report TR2002/10/02*. Patras, Greece: Computer Technology Institute.
- Katzenbeisser S., Petitcolas F. A. P., 2000, *Information Hiding - techniques for steganography and digital watermarking*. Artech House, Computer Series, pp. 95-172.
- Fotopoulos V., Skodras A. N., 2002b, Geometric Deformations and Watermarking, *Technical Report TR2002/09/02*. Patras, Greece: Computer Technology Institute.
- P. Wayner, 2002, *Disappearing Cryptography - Information Hiding: Steganography and Watermarking*, (Second, pp. 291-318). Morgan Kaufmann.

ABM – SEARCH PILOT PROJECT

Bernt Olle Dahl

ABM-Utvikling, The Norwegian Archive, Library and Museum Authority, Post Box 8145 Dep. 0033 Oslo, Norway –
bernt.olle.dahl@abm-utvikling.no

KEY WORDS: Search Pilot project, Archives, Libraries, Museums, Digital content

ABSTRACT:

The search Pilot project will establish a platform for finding digital cultural heritage content in a selected group of Norwegian Museums, Libraries and Archives. This will be done both by crawling websites and database for metadata to be indexed, as well as establish federated searches by connecting to cultural heritage institutions own search engines. Both vector and single word search will be explored, together with semi dynamic categorization and drilldown functionality. The Pilot project will be used to explore the user requirements, and be a basis for the full cultural heritage search implementation.

1. PILOT PROJECT INTRODUCTION

1.1 The Norwegian Archive, Library and Museum Authority (ABM-utvikling)

The Norwegian Archive, Library and Museum Authority (ABM- utvikling) was established on 1st January, 2003 following the merger of the Norwegian Directorate for Public Libraries, the Norwegian Museum Authority, and the National Office for Research Documentation, Academic and Special Libraries. ABM- utvikling is an advisory and executive organization for the Ministry of Culture and Church Affairs on the special fields of archives, libraries and museums. It is the task of ABM-utvikling to carry out active strategic development work for the co-ordination, rationalization, and strengthening of the archive, library and museum sectors. The aim is to put the constituent sectors and individual institutions in a better position to solve the tasks that relate to their specialist subjects and to find ways of meeting the new challenges presented by society and technology. Internet and digital cultural heritage content provides a new way of creating new insight and knowledge for all citizens. The Pilot project is based on utilization of these new technological possibilities.

1.2 Engagement in EU projects

ABM- utvikling is a partner in the EUROPEANA best practice network, coming out of the former European Digital Library project.

The EUROPEANA project will launch an open Pilot search on internet, by November 2008. This EUROPEANA Pilot will give the users (EU-citizens) access to about 2 mill digital objects (i.e digital-books, pictures, photos, documents etc), and will be enhanced to about 8 mill digital objects by 2010.

ABM- utvikling has recently also become a partner in the EUROPEANA-Local project, which aim at collecting digital objects and provide them to the EUROPEANA internet search and presentation site.

2. THE SEARCH PILOT PROJECT

1.3 Background for the Pilot project

The background for the Pilot project is that ABM-utvikling in 2006 undertook the task of writing a report on the status and future of digital material in the MLA sectors, MLA being the abbreviation used for Museums, Libraries and Archives.

The report (ABM-SKRIFT # 32 2006, *Cultural heritage for all*) gives a brief overview of the status on digitization in the MLA-sectors in Norway. One action coming out of this work is to run a search Pilot project. The aim for this Pilot project is to test out and show how the cultural heritage material in MLA - Institutions could be searched for by all users like students, citizens, experts, researchers etc. The search Pilot project should also point out the possibilities and challenges in developing and running a full scale solution project.

1.4 Vision for the PILOT project

The challenge given us is to collect and organize information and content, as well as answer a set of questions. The questions users want answers to is illustrated in the figure below:

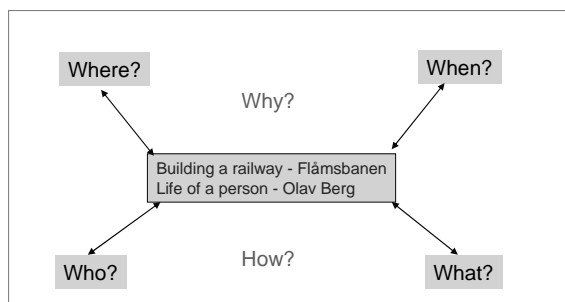

Figure 1: Questions asked

Especially the why and how questions are tricky to answer, since they require knowledge and insight from the people providing the information, and can in no way be automated.

Our vision for the Pilot project is to test and verify a proof of concept, to show that it is meaningful to search for and to make

available all digital cultural heritage content available via internet.

In addition we would test out the possibilities to organize and present the result to the user in such a way that the questions in figure-1 can be answered.

1.5 Pilot project limitations

The Pilot project needed to be developed within some limitations:

- We will only engage digital content which is open to the public from a limited group of Norwegian MLA - institutions (about 100).
- We will use a pragmatic approach in the way that we search, collect and index what we can get from these sources/institutions without restrictions to metadata content or digital content formats.
- We will use a limited amount of money within a limited timeframe autumn-2007/autumn-2008
- We will not develop or technically run the Pilot project solution, since we believed the vendor to be better at doing that.
- The user functionality will be limited, but includes a specified set of basic search and categorization functionality, and show us the direction of the full implementation.
- The availability of the Pilot project is not public, but will be limited to the project it self and the cooperating institutions.

2. PILOT PROJECT- STRATEGIES AND PLAN

2.1 Overall goal and strategy

The PILOT project is a limited implementation of a full scale search, for digital cultural heritage content. The overall goal and strategy in the Pilot project is to show that:

1. It is of interest to the user – both content wise as well as functional to search for and retrieve cultural heritage content in this way
2. It is technically possible to implement in today's heterogeneous internet landscape
3. It is possible to implement a fully developed user platform in a project phase-2 that can include all the functions, services and tools required by the users within an economical feasible frame.
4. We do not want to be involved in the discussions on formats and metadata standards in the Pilot project, we get and present the digital content we find when searching
5. To avoid development of known technology, and concentrate on the user interface and services, we wanted the search engine to be a commercially provided, operated and supported product like Autonomy, Fast, Lucene (open source), and Intellisearch etc.

2.2 Sources and content collection strategies

The source of digital cultural heritage content is very diversified in the MLA- sectors, as well on geographical level, or field of topics they covers, as illustrated in figure-2 below.

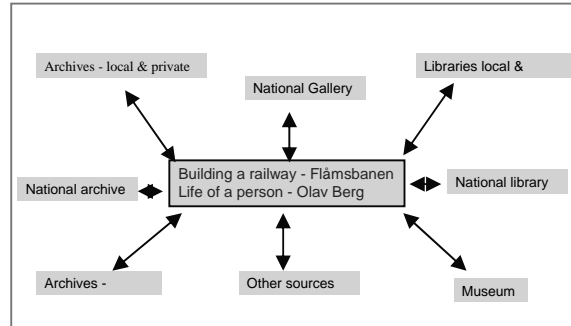

Figure 2: Sources and institutions with cultural heritage content

The institutions differ very much in size collection wise and where they are in the process of making their collections available and visible on the internet.

To show a broad variety of content we have therefore selected institutions from all MLA sectors to participate as well as institutions on different geographical and “organizational” levels.

We have selected the following three types of sources for the Pilot project:

A) Indexed search by web crawling: This represent a searchable index hold in a central database collected from a set of 90 selected open internet sites/pages.

B) Distributed/federated search: The search is transferred to the search engine of the source institution or collection owner site, and a search is initiated with their local search engine on their index. The results are then displayed as a federated search together with the indexed search.

C) Deep web/databases: A programmed connection is established to collect metadata from a database and index it together with the index in A).

2.3 Search strategies and challenges

The search initiated by the user is performed by the search engine in two principally different ways:

- Indexed search in a centrally hold index collected by crawling WebPages and databases
- Federated search from larger institution sources, executed on their own index and with their own search engine. This would normally be the National library, National archive etc.

These two ways of search in metadata and in digital content, gives some pro and cons to take into consideration in the way the Pilot project operate, and how we should go ahead with this in the full implementation.

3.3.1 Indexed search: This gives us the possibility to give all the hits (findings) a relevance % over the total index, and it also gives the user quick response and good categorization functionality for the search result.

On the other hand to collect and index all metadata and content would probably generate a huge central index, and in some instances also some security/access issues regarding the metadata content and ownership.

Management of crawling and indexing web-pages can need a lot of work, due to advertising, link death, use of flash/java etc.

3.3.2 Federated search: This gives us the possibility to utilize already indexed material at the source institution, and also utilize the institutions own search engine. The material will be found and presented in the way that the cultural heritage institutions want it to be.

The decentral/federated search will be asynchronous, and take the time the infrastructure in the network and at each of the source institutions will allow. There can be security/access issues that can be handled in this way. In a federated search one cannot give a common relevance % since it is based on different indexes and algorithms. On the other hand one does not need to update a large central index.

The need to update API's (Application Program Interfaces) and web services when changes takes place (new version of software etc), can become quite cumbersome.

2.4 Pilot project plan

The Pilot project was initiated in 2006 with a startup early in 2007. In the project plan shown below the major steps are outlined, and also includes the startup of the next phase.

The Phase-2 project will basically establish a first version of a full implementation of the cultural heritage search.

ABM-search project plan												
Activity	Year-->											
	2007		2007		2008		2008		2009		2009	
Period-->	Q2	Q3	Q4	Q1	Q2	Q3	Q4	Q1	Q2	Q3	Q4	
PILOT-project												
Requirement specification												
Bid and vendor selection												
Implementation & acceptance												
Enhancement/source update												
Dissemination & evaluation												
Full implementation- Phase-2												
Requirement specification												
Bid and vendor selection												
Implementation & acceptance												

Figure 3: Pilot project plan

4. PILOT PROJECT CONCLUSIONS

4.1 Pilot projects conclusions – so far

The testing and evaluation of the cultural heritage search pilot is still underway, but some preliminary conclusion can be made:

- there are lots of interesting open digital material out there to be searched for
- a search for digital cultural heritage content can add value to the overall search landscape for the citizens
- the technology is there, but we need to form it and position it in such a way that it serves the users
- the cultural heritage institutions and software vendors are eager to be working with us, for the full implementation of a search platform
- there are technical challenges connected with where to keep the index, what to collect and how to organize this and standardize on formats

- there are challenges connected to IPR – Intellectual Property Rights as well as restricted material due to personal protection laws and access to newly published/produced material (2000th century)
- there will be operational challenges connected with the running of a search platform, due to the fact that the internet technologies are changing, and the sources with it, regarding access and content
- we believe that a cultural heritage search can be something else than what common internet searches can provide, since we can qualify all sources and content
- we also believe that we can provide functionality, tools and services to the end-user population, which the common internet searches not do, nor will be able to do

Based on these findings the pilot project strongly indicates that it will be worthwhile to go ahead with a full implementation.

5. FUTURE IMPLEMENTATION

5.1 Next steps

From the very start it was clear that the pilot project was just that, with results and conclusions pointing in the directions where to move for a full implementation.

Based on the benefit we all can draw from having one high quality access to all Norwegian cultural heritage kept by the cultural heritage institutions, it seems to be worthwhile to go for a phase-2 and a full implementation at this time (the evaluation not being finished yet).

5.2 Phase-2 directions of development

5.2.1 View on users: The full implementation can however only be done, if the focus is on the user groups and user roles that we want to address, and our ability to fulfill their needs and wishes. We want to explore the different user-roles to clarify their needs and requirements they represent. (Pupils- professors- students- authors- experts- etc.)

User participation is also very much in focus here, to span out the total requirements space.

5.2.2 Digitization and sources: We need quality content, and subsequently we need to provide solutions, methods and competence for the digitization of quality content in the MLA-sector. Common metadata and content formats, cross border cooperation of MLA institutions are necessary to agree on formats, systems, exchange etc.

In a full implementation we want to give the user's access to all open cultural heritage sources in Norway, as well as abroad.

5.2.3 Functionality and tools: The search platform solution must focus on the functionality, services and tools we provide to the users. Examples of this could be user participation services, curator studios for development of e-Exhibitions, access control, myCollection, save- search, Wikipedia & EUROPEANA links etc.

One important feature we are looking for in Phase-2 will be to distribute the search functionality by being able to "move" it out into the cultural heritage institutions own homepages, and to be able to restrict the search to a region and/or the institutions own

databases/collections. This will of course have the same functionality, as in the central search platform.

5.2.4 Semantic web, context and enriched metadata: In the full implementation, semantic web and content context as well as content enrichment through user and expert participation will very much be focused and influence the selection of user functionality beyond the trivial search and drilldown functions. We see that each and every digital content object out there has a history and its own universe which it “lives” in, but the description of this, the links and relations to other objects has to be developed and described.

In the earlier mentioned EU project EUROPEANA, one has achieved good progress in defining and describing this.

5.2.5 Enrichment of user experience: In the view of the desire to enrich the content and expand the value to the users, we have to initiate and motivate both users and experts to develop descriptions and metadata which gives more information on the basic what – where – when – who questions.

We want the users to get access to all the “raw” content as well as ready curated material in the form of documents, exhibitions, articles etc. Quality articles on subjects, internet exhibitions, information and knowledge organization in combination with Quality metadata and content gives the possibility to enrich the search experience in many ways. Some of which would be the use of digital maps to see *where*, use of timeline to see *when*. The use of enhanced drilldown (dynamical categorization) features, synonym word tables and name authority registers are further examples of this.

6. REFERENCES

ABM-SKRIFT # 32 2006, *Cultural heritage for all – on digitization in the archive, library and museum sector*
Editor: Ranveig L. Gausdal, ISBN-82-8105-040-3

ABM-Utvikling, information can be found at:
http://www.abm-utvikling.no/?set_language=en

EUROPEANA, information can be found at:
<http://www.europeana.eu/>

EUROPEANA Local project, information can be found at:
<http://www.europeanalocal.eu/eng>

Virtual Reality Applications in Cultural Heritage

A CONTACT-LESS INTERACTIVE TOOL FOR EXPLORING ARCHAEOLOGICAL DATA

Frangiskos Frangeskides ^a, Andreas Lanitis ^b and Giorgos Papantoniou ^c

^a DHL Cyprus , P.O. Box 22002, 1515, Nicosia, Cyprus,
frangiskos.frangeskides@dhl.com

^b Dept. of Multimedia and Graphic Arts, Cyprus University of Technology , P.O. Box 50329, 3036, Lemesos, Cyprus,
andreas.lanitis@cut.ac.cy

^c Archaeological Research Unit, University of Cyprus, P.O. Box 20537, 1678, Nicosia, Cyprus,
papantog@tcd.ie

KEY WORDS: Interactive Environments, Usability, Interface Design for CH Applications

ABSTRACT:

We describe a contact-less system that allows interactive information retrieval and exploration. In particular we focus our attention on the development of a contact-less interactive system that can be used for the exploration and visualization of artefacts with archeological interest, using a GIS-based system. The basis of our approach is a tracking algorithm that is able to track head movements of the user. Based on head motion it is possible to move a cursor and select different options, in order to enable data exploration and presentation. The work for this project is in progress. We are currently in the process of implementing an information retrieval system that allows users to retrieve and view information related to Cypriot archaeological artefacts. Although the primary scope of our work is to develop a system that can be used in museums, it is possible to use such systems in other environments such as airports, information kiosks and for general internet browsing. The only extra requirement for using our system is a standard web camera used for capturing images of the user. When compared with other systems currently in use in similar applications (i.e. systems using touch screens), the proposed system offers similar functionality at significantly reduced cost. The results of a preliminary experimental investigation, demonstrate the potential of using the proposed system in applications involving the dissemination of cultural heritage related information.

1. INTRODUCTION

Quite often in museums and other public places, computer-based systems are used for providing additional information related to exhibits. An important issue in such cases is the mode of interaction between perspective users of the system and the information dissemination tool. In most cases the interaction is carried out through the use of standard keyboards, mice or touch screens. The use of conventional human interaction methods that require physical contact may not be the best option for this type of applications because visitors usually carry other items during their visits (i.e. cameras, leaflets, bags etc) that prevent them from using Human Computer Interaction (HCI) devices that require the use of hands.

As an alternative we describe the use of a contact-less human computer interaction system that enables visitors to use computer-based information retrieval systems using head motion. Interfaces based on head motion provide the following advantages when compared to other type of interfaces:

- Ability to interact with a system in a hands free fashion.
- The overall cost involved in setting up a contact-less HCI system can be lower than the cost involved for other types of interfaces (i.e. touch screens).
- The possibility of damage to the interface hardware and the host computer is limited, as users do not have physical contact with the hardware.
- Due to the contemporary nature of this type of interfaces, visitors (especially young children) are attracted to using the information system. As a result they can receive information and knowledge in an interesting game-based

environment. According to Prensky (Prensky, 2003) learning activities in game-based environments can be more effective than traditional ways of learning.

- Since the interaction is done in a contact-less way, potential users will not have hygiene related reservations in using the interface.

The proposed system is based on a head and eye-tracker capable of tracking eye movements of users within the optical view of a standard web-camera. The tracking process is activated automatically when users enter the field of view of the camera, so that users can use the system instantaneously. The face tracker activates cursor movements consistent with the detected head motion allowing the user to control cursor movements and activate mouse clicks. Figure 1 shows a user using a computer system based on the system developed.

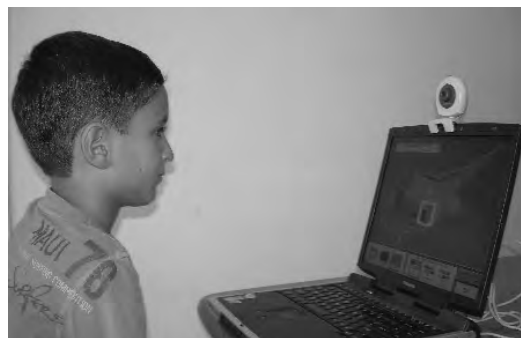

Figure 1: Example of the head-motion-based interaction system

The operation of the head tracking system is optimized for use in relation to an information retrieval application that can be used for obtaining information related to archaeological Cypriot artefacts from the Cyprus Archaeological Museum in Nicosia. The applicability of the contact-less system in relation to the application mentioned above was evaluated by a number of volunteers. Early results demonstrate the potential of this approach for applications involving information dissemination for cultural heritage (CH) applications.

In the remainder of the paper we provide a brief literature review related to interfaces used in museums and we describe briefly the head-based contact-less HCI system. In section 4 we describe the application that we used in conjunction with the HCI system and in section 5 we present preliminary results of a human-based evaluation experiment that aims to assess the applicability of the proposed system for interfacing with computers in museums. Concluding comments and plans for future work are presented in section 6.

2. LITERATURE REVIEW

The topic of developing improved ways of disseminating information in museums (Stock, 2007; Hornecker, 2006; Hsi, 2002) or information kiosks (Maguire, 1999) received significant attention. The aim for these efforts is to attract and encourage visitors to seek information related to the exhibits, using elegant and non-invasive methods. Such efforts focus on four elements which are (1) an effort to design contemporary interaction methods so that users are attracted to use information systems, (2) to provide an easy way to use the system (3) to increase the educational impact of a system, by presenting information in an interesting and engaging way and (4) to enable interaction between visitors (Grinter, 2002). With our work we concentrate on dealing with the first two issues, since we aim to present a contemporary head motion-based interaction scheme that facilitates the process on information retrieval.

Human computer interaction using head movements has been investigated by a number of researchers. In a related survey paper, Duchowski (Duchowski, 2002) provides a thorough discussion on the use of eye tracking in different applications, including the control of interactive displays. Toyama (Toyama, 1998) describes a face-tracking algorithm consisting of a number of layers. The tracking process starts with a layer dedicated to skin detection and through an incremental approach they introduce more capabilities into the tracker. Information related to the face position and pose recovered during tracking, is used for moving the cursor on the screen. Gorodnichy and Roth (Gorodnichy, 2004) describe a template matching based method for tracking the nose tip in image sequences captured by a web camera. In the final implementation cursor movements are controlled by nose movements, thus the user is able to perform mouse operations using nose movements. Zhu and Ji (Zhu, 2004), perform eye tracking based on infra red illumination and the use a neural-network based approach for mapping the position of the eyes to screen coordinates, enabling in that way the control of cursor movements using eye-motion. Zhu and Ji tested their system on using graphic displays applications involving the retrieval of information from maps. Frangeskides (Frangeskides, 2006; Frangeskides, 2007) describe a multi-modal head-based HCI system that enables paraplegics to use a computer in a hands-free fashion.

Several commercial head movement-based HCI systems are available (www.abilityhub.com/mouse/). In most cases head tracking relies on special hardware such as infrared detectors and reflectors (www.naturalpoint.com/smarnav) or special helmets (www.orin.com/index). Hands free non-invasive systems are also available in the market (www.cameramouse.com). Such systems usually aim to provide an interaction tool for the handicapped rather than providing a generic human computer interaction facility suited for applications in public areas.

With our work we aim to target specifically the problem of designing an interface, which can be used for disseminating information in a museum environment. Both the case study and the evaluation process employed, target these types of applications.

3. CONTACT-LESS HCI SYSTEM

In this section we briefly describe the operation of the contact-less HCI system developed as part of our work.

3.1 Face tracking method

We have developed a face-tracking algorithm based on integral projections. An integral projection (Mateos, 2003) is a one-dimensional pattern, whose elements are defined as the average of a given set of pixels along a specific direction. The use of integral projections for representing rectangular image regions results in the representation of image windows using two one-dimensional vectors, enabling the implementation of efficient pattern matching methods. Apart from the ability to provide compact representation of image structures, representations based on integral projections can be noise free, since the process of estimating integral projections involves averaging operations that eliminate noisy responses.

During the tracking process we generate a template of the object to be tracked, by estimating the horizontal and vertical integral projections of the object. Given a new image frame we find the best match between the reference projections and the ones representing image regions located within a predefined search area. The centre of the region where the best match is obtained, defines the location of the object to be tracked in the current frame. This procedure is repeated on each new frame in an image sequence.

The method described above formed the basis of the face-tracking algorithm used for tracking faces in a public environment. The face tracker developed, tracks two facial regions – the eye region and the nose region (see figure 2). The nose region and eye region are primarily used for estimating the vertical and horizontal face movement respectively. Once the position of the two regions in an image frame is established, the exact location of the eyes is determined by performing local search in the eye region.

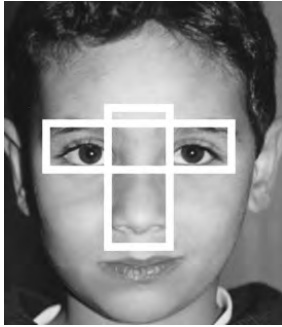

Figure 2: The Nose and Eye Regions

In order to improve the robustness of the face tracker to variation in lighting, we employ intensity normalization so that global intensity differences between integral projections derived from successive frames are removed. Robustness to face rotation is achieved by estimating the rotation angle of a face in a frame so that the eye and nose regions are rotated prior to the calculation of the integral projections. Constraints related to the relative position of the nose and eye regions are employed in an attempt to improve robustness to occlusion and excessive 3D rotation. In order to apply topological constraints related to the positions of the search areas, we collect statistics of the relative positioning of the two search areas so that during the tracking process excessive violations of the expected positions are not allowed. Both the enforcement of topological constraints and lighting normalization, improve the robustness of the system to lighting variation and extreme face rotation, making the system suitable for use in public interfaces.

The accuracy of the tracking algorithm was evaluated using pre-recorded image sequences showing different persons (Frangeskides, 2006). In the test sequences different aspects of the tracking algorithm such as the robustness to changes in lighting, occlusion and excessive face rotation were tested. According to the results of the experiments, the face-tracking algorithm is capable of locating the eyes of subjects in image sequences with less than a pixel mean accuracy. Even in the cases that the tracker fails to locate the eyes correctly, the system usually recovers and re-assumes accurate eye-tracking.

3.2 System Operation

In this section we describe the main operations supported by the system that include the initialization phase, cursor movement and mouse click operations. Although our system supports all types of possible interactions (i.e. double clicks, drag and drop etc) we only describe the operations which are utilized in conjunction with the in-museum information system.

System Initialization: When a user wishes to use the system he/she is required to go through an automatic initialization process, so that the system learns about the visual characteristics of the user. During the initialization process the user is requested to keep his/her face still and perform blink actions. Based on a frame-differencing algorithm the positions of the eyes and nose regions are determined and integral projections for those areas are computed. Once the projections are computed the face tracker is activated. The tracker initialisation process requires approximately 10 seconds to be completed. A screen shot of the initialisation tool is shown in figure 3.



Figure 3: System Initialisation Window

Moving the cursor: The divergence of the face location from the initial location is translated in cursor movement speed, towards the direction of the movement. Based on this approach only minor face movements are required for initiating substantial cursor movement. The sensitivity of the cursor movement can be customized according to the abilities of different users.

Mouse Click: Mouse clicks are activated by the stabilization of the cursor to a certain location for a time period longer than a pre-selected threshold (usually around one second).

4. CASE STUDY

In order to evaluate the system in an application suited to information dissemination in a museum environment, we have implemented a prototype GIS-based application suitable for disseminating information related to Cypriot archaeological artefacts from the Archaeological Cyprus Museum (Nicosia). Such a system can be used in museums and other public places where it is useful to disseminate this type of information. In our preliminary investigation we have stored in the system the minimum amount of data required for staging evaluation experiments. Once the experimental evaluation is completed we plan to enrich the system with more data in order to create a complete e-handbook of all artefacts available at the Cyprus Archaeological Museum. Hereunder we describe the data stored in the system and the operation of the experimental information dissemination system.

4.1 Data Depository

Archaeological artefacts currently stored in the database belong to three different historical phases: the Late Cypriot period (c. 1600 – 1050 BC), the City-Kingdoms era (c. 1050 BC – 325 BC) and the Hellenistic historical period (c. 325 – 30 BC). In our preliminary work we have collected data for about 20 artefacts, from the Cyprus Archaeological Museum, belonging to the three historical phases under consideration. We are currently in the process of enriching the database with more artefacts belonging to a wider range of historical periods. For each data item in the database the following data was recorded:

- Artefact name
- Historical period
- Location where the artefact was found
- Image of the artefact
- Short description of the artefact

Samples of typical data items currently stored in the database are shown in figure 4.



(a)



(b)



(c)

Figure 4: Typical artefacts stored in the system.
 (a) Cylindrical box for cosmetics (Late Cypriot period),
 (b) Terracotta group of two men and bull (City-Kingdoms era)
 (c) Limestone head of a female figure (Hellenistic period)

4.2 System Interface

The system provides a GIS-based interface displaying the locations where each artefact belonging to a pre-selected historical phase, was first found. Figure 5 shows a typical screenshot that displays locations where artefacts belonging to the Late Cypriot period (c. 1600 – 1050 BC) were found.



Figure 5: Screenshot of the system showing the locations where artefacts belonging to the Late Cypriot period were found

The user can select the historical period of interest so that locations of artefacts belonging to the selected period are displayed on the map. Whenever the cursor is directed near an artefact location spot, a thumbnail of the artefact appears on the screen. A mouse click operation displays a full size image and appropriate information of the artefact. An illustration of the operation of the system is shown in figure 6.

Based on this interface a user of the system is able to retrieve information and photographs related to different artefacts using cursor movements and mouse clicks activated using head movements. Special emphasis was given to the design of the buttons and other controls of the interface since the results of a quantitative evaluation of the head-based HCI system indicated that users perform better when they have to click on large size buttons (Frangeskides, 2007).



(a)



(b)

Figure 6: Demonstration of the system operation.
 (a) Displaying a thumbnail related to an artefact wherever the cursor is near the artefact spot. (b) By clicking on the thumbnail information and full size image of the artefact are displayed

5. EVALUATION

In this section we describe our preliminary work in assessing the use of the contact less HCI system in relation with the proposed application. The evaluation process aims to evaluate two aspects of the proposed system. The first aspect is the performance of users in retrieving efficiently information using the head motion-based system. The second aspect of the evaluation aims to evaluate the appeal and educational significance of the system when compared to conventional HCI systems used in similar applications. The evaluation was done based both on quantitative and subjective measures.

In order to support the quantitative evaluation of the efficiency in retrieving data using the contact-less system, a dedicated version of the dissemination information system that contains a 'test-mode' option was developed. In the 'test mode', randomly selected spots on the map interface blink and the total time required by the user in accessing the information linked to the blinking spot is recorded. During the tests this procedure is repeated six times, so that the overall time for accessing information from six spots is recorded.

5.1 Experimental set up

Each volunteer who participated in the experiment had to complete the following evaluation procedure.

Benchmark performance: In order to define the benchmark performance, each volunteer was requested to use the system in 'test mode' using a standard computer mouse. The total time required for accessing information related to the six randomly selected spots is recorded for each volunteer.

Head Motion-based Test: Each volunteer was requested to complete the same test as the one used for specifying the benchmark performance. However in this case the control of the cursor movements and mouse-clicks are performed based on the head-motion system described in this paper.

Questionnaire: Each volunteer was requested to complete a simple questionnaire that contains few questions related to the system. In the questionnaire users were asked to compare the mouse-based against the head-based interaction system in terms of the appeal of each system, the practicality in using the system, the fun factor and educational impact. For each question volunteers were requested to assign an 1 to 5 score where 1 meant lowest mark and 5 meant top mark. The mean response among the 15 volunteers was quoted.

5.2 Results

In this section we present the preliminary evaluation results obtained when 15 volunteers participated in the experimental evaluation process. A summary of the results are shown in tables 7 and 8. Due to the small number of volunteers who participated so far in the experiments it is not safe to produce concrete conclusions. However the main trends among the test group can be identified. According to the results the total time required for accessing data using the head-motion based system is significantly longer when compared to the total access time required when a conventional mouse is utilized. This is expected since most users have experience in using a mouse for interactions tasks (see table 7). It is also expected that users rated the practicality of the mouse-based interaction system

higher, since a mouse-based interface presents a highly practical interaction mode (see table 8, row 4).

However, in the remaining evaluation issues (see table 8) volunteers rated the appeal and fun factor of the head based system higher than the ratings for the mouse-based interaction system. These ratings prove that contemporary forms of interaction can attract subjects to use information retrieval systems so that information dissemination will take the form of an entertainment/computer game activity. We believe that the proposed system can play a significant role in attracting and encouraging visitors to spend more time seeking information through in-museum information systems.

Quantitative Performance (Mean Time required to access information from six spots)	
Mouse	Head-Based
18.1 seconds	79.3 seconds

Table 7: Summary of quantitative evaluation results

Questionnaire (answers in scale 1-5, lowest to highest score)		
Question	Mouse	Head-based
System Appeal	3.0	4.4
System Practicality	4.7	2.7
Fun Factor	2.2	4.7
Educational impact of system	3.5	3.9
Interested to use system again?	3.7	4.6
Are you going to recommend your friends to use the system?	3.6	4.5

Table 8: Preliminary questionnaire-based results

6. CONCLUSIONS

We have presented our preliminary work towards the design and evaluation of a head-based human computer interaction system that can be used for retrieving information about archaeological artefacts in a museum. As part of our work in this area we developed a customised head-based HCI method, that can be used for controlling interactive displays in public places such as museums and exhibitions. We also developed a prototype application that allows users to explore and visualize archaeological Cypriot artefacts belonging to three historical phases.

The results of a preliminary experimental evaluation proved that the use of the system does not result in faster interaction but it presents a more interesting and attractive way to use a computer information system in public places such as museums or information kiosks.

In the future we plan to carry out more work in this area in order to deal with the following issues:

- Improve the head-based interaction system, so that it will be possible to access data faster.
- A more rigorous evaluation process will be staged so that quantitative results and subjective results related to the performance and appeal of the system will be collected and analyzed. In particular we aim to run evaluation experiments using a large number of volunteers and analyze the findings for volunteers of different age groups, genders and educational backgrounds. Also we plan to run experiments in public places (i.e. museums) so that we get specific results of the appeal of the system among museum visitors.
- Enrich the database with Cypriot artefacts so that the system will operate on an almost complete selection of Cypriot artefacts.

Currently the system is an HCI system that can be used for retrieving information through the use of a computer application. In the future we also plan to upgrade the system so that the head motion of visitors of a museum standing in front of a display will be detected, and based on the eye location and direction, the artefacts currently viewed by a visitor will automatically be determined and information for that artefact will be displayed automatically in a display area. With this system visitors will be able to view simultaneously both the artefact and information about it.

7. REFERENCES

References from Journals:

Duchowski AT., 2002. A breadth-first survey of eye-tracking applications. *Behavior Research Methods, Instruments, & Computers*, 34(4), pp. 455-470.

Gorodnichy D.O. and Roth G, 2004. Nouse 'Use Your Nose as a Mouse' – Perceptual Vision Technology for Hands-Free Games and Interfaces, *Image and Vision Computing*, 12(12), pp 931-942.

Maguire MC, 1999. Review of user-interface design guidelines for public information kiosk systems. *International Journal of Human-Computers Studies*, 50(33), pp. 263-286.

Prensky M, 2003. Digital game-based learning, *ACM Computers in Entertainment*, 1(1), pp. 21-21.

Zhu Z. and Ji Q. 2004, Eye and gaze tracking for interactive graphic display, *Machine Vision and Applications*, 15(3), pp 139-148.

References from Books:

Frangeskides F. and Lanitis A. 2006. A Hands-Free Non-Invasive Human Computer Interaction System. *Advances in Systems, Computing Sciences and Software Engineering*, T. Sobh and K. Elleithy (editors), pp 235-242, Springer.

Karageorghis, V. 1989. *The Cyprus Museum*, Nicosia. Nicosia: Epiphaniou Publications Press.

Stock O. and Massimo Z. 2007. *PEACH - Intelligent Interfaces for Museum Visits*, Springer-Verlag.

References from Other Literature:

Frangeskides F. and Lanitis A. 2007. Multi-Modal Contact-less Human Computer Interaction. Best papers from the 8th International Conference on Enterprise Information Systems, *Lecture Notes in Business Information Processing*, Springer, pp 405-419.

Grinter, E., Aoki, M., Hurst, A., Szymanski, H., Thornton, D. & Woodruff, A., 2002, Revisiting the Visit: Understanding How Technology Can Shape the Museum, *Proceedings of the 2002 ACM conference on Computer Supported Cooperative Work* pp.146-155.

Hornecker E. and Stifter M. 2006. Learning from interactive museum installations about interaction design for public settings. *Archive Proceedings of the 20th ACM conference of the computer-human interaction special interest group (CHISIG)*, 206, pp. 135 - 142 .

Hsi, S., 2002, 'The Electronic Guidebook: A study of user experiences using mobile web content in a museum setting' *Wireless and Mobile Technologies in Education*, *Proceedings IEEE International Workshop on Wireless and Mobile Technologies in Education*.

Mateos G.G. 2003. Refining Face Tracking With Integral Projections. *Procs. Of the 4th International Conference on Audio and Video-Based Biometric Person Identification*, *Lecture Notes in Computer Science*, 2688, pp 360-368.

Toyama K. 1998. Look, Ma – No Hands! – Hands Free Cursor Control with Real Time 3D Face Tracking, *Procs. Of Workshop on Perceptual User Interfaces*, pp. 49-54.

8. ACKNOWLEDGEMENTS

We would like to thank the Director of Cypriot Department of Antiquities for giving us permission to use the images of Cypriot artefacts displayed in figures 4 and 6. All images of Cypriot artefacts shown in figures 4 and 6 were published in (Karageorghis, 1989).

VIRTUAL REALITY RECONSTRUCTION AND VISUALIZATION TO PRESERVE CULTURAL HERITAGE: SANTIMAMIÑE, A SUCCESSFUL CASE

S. Barrera ^a, U. Baeza ^b, A. Otaola ^c

^a Dept. of Innovation, Virtualware, Pol Artunduaga, C/ Usausuaga 5, mod 5,6,7, 48970 Basauri, Spain –
(sbarrera, ubaeza, aotaola)@virtualware.es

KEY WORDS: Virtual Reality, Virtual Caves Reproduction

ABSTRACT:

The cultural heritage is a really important resource of every country; nevertheless it suffers certain problems and limitations that make more difficult its communication and spreading. The Santimamiñe cave located in Urdaibai, has suffered the ravages of time and human damages since its discovery in 1916 until its closure for visitors was forced in 2006. However, all the richness of the archaeological and geological group, such as the cave paintings contained in the cave rooms, were affected regarding with its spreading and stopped somehow its tourist attractive. New technologies join to sort out these problems and try to minimize the damage by means of this project: "Santimamiñe: a thousand year old landscape ".So, starting on a laser scanned system and using the virtual reality technology, essential crux of the project, the goal of carrying out a virtual replica of the whole cave in extremely great detail has been reached, which achieves the purpose of respecting the environment in a non-intrusive way. An exhaustive process of research and work was necessary to obtain the final result: the recreation of the cave which has become a model in Spain as well as a transversal technological solution that has obtained a deeply satisfactory impact, not only on the visitors because of the interactivity and immersion of the technology but also by the own interpretation centre.

1. INTRODUCTION

1.1 The natural cave of Santimamiñe

The natural cave of Santimamiñe was one of the main heritage and tourist resources and of the north of Spain. Since the cave was discovered in 1916 a large number of people had visited the cave to contemplate the cave paintings and archaeological richness of the cave. Aranzadi, T. (1925) and some other experts carried out several studies and archaeological and excavations in the cave analysing the deposit and new figures have since been found in several parts of the cave.



Figure 1: Santimamiñe cave paintings

The natural cave is located in the hill of Ereñusarre, very near the village of Kortezubi, in Vizcaya. It is situated in an area of great natural beauty, in the heart of Urdaibai, an area of 220 square kilometres which was declared a "Reserve of the Biosphere" by UNESCO in 1984.

1.2 The problem

The cave suffered a big damage along the time, due to the natural deterioration and human intervention: Handrail and different device were installed inside in order to attract tourists, and between 800.000 and one million of people have visited the cave.



Figure 2: Stairs installed in Santimamiñe cave

Biscay City Council was aware of the danger that these visits meant decided to definitely close the cave to the audience. Greaves B. (2006) presented the study and all the reasons for this decision. However the tourist attraction was stopped by this fact. The cultural offer affected even the area, decreasing the cultural and tourism incomes.

1.3 Searching a solution

The study programme was developed of the Cultural Department of Biscay Provincial Council in which the first step was the closure in 2006, and afterwards the idea of "virtual replica" came up.

1.4 Comparisons between replica

The ordinary scale models involved a high investment, adding some difficulties they are shown in the following table:

	Real replica	Virtual replica
Size	Very large	Depends on the displaying device
Ubiquity	Difficult transportation	Multiple places of widely diffusion, (exhibitions, CDROMs, web,...)
Reliability	Subjective artistic contribution	Laser scanning + photogrammetry
Servicing	Complex	Simple (computer servicing)
Scalability	Null	Complete
Costs (Development and servicing)	High	Notably lower

Table 1: Comparison between replicas

The responsible authorities of the project in expert in technology field start working together with Virtualware, already experienced to tackle the problem and find the suitable virtual solution for the specific case of Santimamiñe.

The main advantages of virtual reality contribute better in the whole project. The main **properties** of this virtual solution are as follows:

- **Adaptable** everywhere: being a digital solution it may be presented in different formats according to the available room. From PCs spread in a lounge to a stereoscopic large screen system.
- **Scalable**: Virtual Reality technology allows a whole scalability in every sense.
- **Reliable, accurate**: Very accurate advanced methods of picking up information are used to develop the environment.
- **Innovator**: It allows the user to interact with and even make a tour over the cave observing the different details.
- **Simple servicing**: The application does not need any kind of servicing and only computers devices or projectors do need servicing.
- **Customized**: It allows the incorporation of additional multimedia information in the environment according to the specific requirements of every project.

2. VIRTUAL REALITY

2.1 Initial Approach

The first approach was simply based on the idea of a virtual replica that could reproduce the 5 rooms of the cave that the audience had could visit avoiding the access inside. The physical visit as Gomez (2006) agrees is one of the main factors against the caves conservation.

2.2 Improvements

After studying the feasibility of the project, Virtualware propose to wide it in different aspects, proposing the following improvements:

- Continuous model of the 365 metres along the 10 rooms of the cave, even the ones which never were able to visit.
- The use of a professional 3D scanner to take the entrance data that can produces detailed archives of the important elements. (La Pensée , 2004).
- Realistic textures extracted from photography taken from the real cave in order the give the most similarity
- Multimedia boards to explain the different interest points in the cave: cave paints, archaeological sites and the impressive geomorphologic.
- Surround audio system 5.1 to set in the prehistoric ages.
- Translation in different languages: Basque, English, French, to attract international tourism.
- Easy way to navigate through the virtual environment.

3. WORKING PROCESS

3.1.1 3D Model construction

The working process lasted 7 months of different phases of the project explained below:

The process used for virtual reproduction of a cave is based in the following steps:

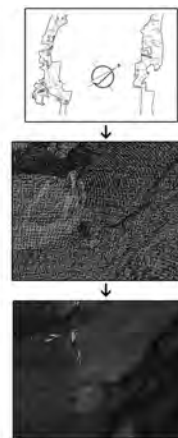

Figure 3: Modelling process

- Data collection in the area

Datum materialization and 3D Laser scanning.

A reference network (plan) is created based on a polygonal using a topographical station. Drawing up a plan for a reference network it will be used to correlate the different reference systems of each of the points acquired.

The laser scanner is placed in different locations inside the cave, previously geo-referenced, this way the spherical scans obtain the point clouds.

These point clouds contain information of every accessible point visually in the scanner line of sight .

This information is a 4D vector axis that contains the X, Y and Z of every point regarding the scanner location, as well as the dimension of the power reflected in the surface.

Every scan consists of 26 million of points, and to get the model of the cave, a total amount of 200 scans were needed. Therefore 5200 million were obtained.

Digital photography

To achieve a realistic virtual model of the cave, the colours obtained from high quality digital photographs will be applied to the models created.

These pictures will be superimposed as textures over the virtual surfaces in the modelling phase. They will also enable to extract normal maps in order to apply rough effects to the rocks.

Multispectral analysis

The significant areas of the cave due to its pictorial importance are analysed using software that enables to filter the clouds of points in order to obtain the exact location of the cave paintings. Reference vectors are obtained to locate the photographic texture related to the cave painting art.

A complex unstructured model of 3d points and pictures of the whole cave is obtained.

- Data processing in cabinet

Previous data processing from 3D scanning

The point clouds are processed obtaining a continuous model which will be used to generate the 3D model. This process is distinguished by the following phases:

- Filtering
The points overlapped from different reference points, background noise caused by dust interference and reflected lights generated by the surface's humidity.
- Registering
This process is based on locating all the point clouds in a common reference system. Using a topographical polygonal which contains the reference points, a geometrical transformation of every point of each cloud will be geometrically transformed.

Data processing from 3D scanning

Afterwards the continuous model of points is transformed into a polygonal model. After having done different attempts with different commercial packs like, Polyworkds, Rhino 3D, Technodigit 3DReshaper, as well as Open Source MeshLab, the 3DReshaper meshing software was selected to this aim.

Its enormous throughput with big data volume and its easy handling for repeating jobs and its good price-value were the main reasons to be selected. However the main feature was the ability to process 5200 millions of points in the short period of time of 4 months.

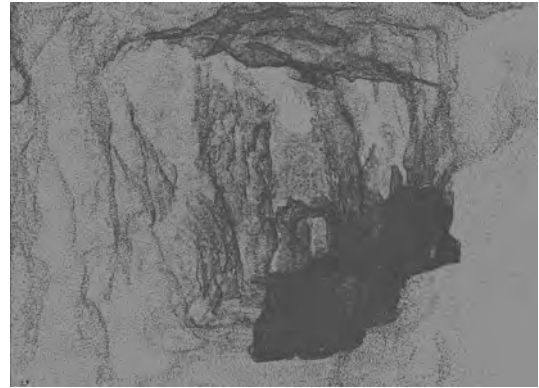

Figure 4: Points cloud



Figure 5: Wireframe



Figure 6: Texture and light application

3.1.2 Selecting Target Software Platform / 3D Engine

To decide which platform to use we had to study input requirements.

- Initial Requirements
 - High quality graphics / appearance.
 - HLSL pipeline.
 - Very high polygon model real time capable software.
 - Portal Rendering.
 - Stereo render capable software.
 - Two viewport
 - Need to obtain prompt results.
 - Modular design capable software.

After this task, we noticed there was no such system fulfilling our expectation, so we decided to implement some missing modules over a commercial platform.

We chose Quest3D due to its high graphic performance and facilities to mix multimedia contents with virtual reality.

To reproduce a realistic natural appearance of the cave “High Level Shading Language” scripts were developed.

The HLSL pipeline is divided in two steps, one for every vertex in the geometry, and another for every pixel produced. It takes four textures as input, diffuse colour, specular colour, normal map and light map, with some material info and two lights, directional and spot. In the first step, vertex and lights positions are transformed to view space, and tangent space vectors are calculated for the next step. Light distance and angle are also calculated for the directional and the spot light, respectively.

Next, is where the actual work occurs, the final colour of the pixels is calculated with several methods. The normal is obtained from the normal map, and transformed to world space with the tangent space vectors from the previous step, this way, it is able to add more detailed normals without adding geometry.

The normal is deformed to simulate relief using a technique called parallax mapping (Tatarchuck, 2005) that uses the alpha channel in the normal map to store depth information, and then use it to displace the uvs. Also diffuse colour, specular colour and light colour are obtained from their respective maps, all of them from a single uv coordinate, but different uvs could have been used if necessary. Lights contributions are calculated separately in diffuse and specular lighting, and applied a constant, linear and/or quadratic attenuation. All this information is combined to obtain the final pixel colour.

Every surface inside the cave was represented using a combination of four textures mixed in HLSL pipeline:

- Diffuse textures for main colouring.
- Precalculated Baked Lightmap textures for a realistic illumination.
- Precalculated Normal map textures which allow displaying more detailed surfaces without adding polygon overload (Tarini, M et al, 2000)
- Specular maps to simulate humidity in some zones.

This way each rendered pixel is calculated depending on different lights positions, camera position and per pixel normal vector in real time.

3.1.3 Application Setup

The content to be shown and the guide were developed at the same time than the software and programming due to the lack of time, so a flexible platform was chosen as application strategy. This working way makes possible add different contents and modelling the final result depending on them.

This strategy enabled to make changes in any multimedia element in a quick way. The application currently enables contents an edition system of the positional contents, and the guide is represented using “Finite State Machine” like Kam (1997) started studying.

The application has been divided in different status depending on the guide and localisation inside the cave. The mentioned statuses are at the same time sub robot that control what happens in the sequence.

- Animation Cameras / Interpolation
- Human interfacing.
- Showing multimedia contents.
- Application events.
 - Switching on/off lights
- Sound reproduction
 - Voices
 - Music

3.1.4 Hardware Integration

The solution has been installed in a hardware located in the interpretation centre, nearby the cave. It is a stereoscopic system.

The system combines Barco Infitec tm Projection (Barco Galaxy 7 with Infitec), with a Large Stewart Stereoscopic Screen.

Infitec Technology allows passive glasses with the benefits of using just one projector.

The nearby chapel San Mamés a XII century building was the place selected to house the visualization system as well as still being the ritual place it plays the role of an interpretation centre at the same time.

The visualization room has 20 people seating capacity who need to wear 3d passive Infitec glasses to enjoy the immersive virtual visit. The guide directs the tour accessing the different interesting points in real time attending the audience requirements in order to make it more interactive and different.



Figure 7: Barco Galaxy 7 over Stewart Screen installed in the interpretation centre.

Furthermore, for the correct virtual tour setting, 5.1 digital audio system has been installed, that enable to place different origin points to stem the audio sound strengthening immersive atmosphere.

4. CONCLUSIONS

The main challenge of the project was to develop software able to balance correctly the large quantity of entry data against virtual reality limitations existing nowadays.

Specific modules of software designed to convert in point-clouds obtained from laser scanner, into high definition polygonal models.

The objective has been fulfilled successfully in two sides: The technical result obtained defies the imagination. During all the process different valued elements were added.

By the other hand the impact on the media has been a successful case. The visitors enjoy the virtual tour inside the cave, only in the first two weeks..... since the opening proves the expectation....

Apart from the advantage of this solution that provides to get an interactive environment of Virtual Reality with a high level of resemblance with the cave, it can be diffused by the possible different means of:

- Advanced systems of Virtual Reality at interpretation centres, exhibitions and events: huge screens, Virtual Reality helmets.
- Interactive CDROMs and WEB sites

5. REFERENCES

Aranzadi, T., Barandiaran, J. M. & Eguren, E., (1925) *Exploraciones en la caverna de Santimamiñe*, Basondo, Cortezubi, Spain.

Gómez L,M., (2006) "El patrimonio abierto a todas y todos: Proyectos de Inclusión, Ponencias IV Jornadas AIP, Granada, Spain
<http://www.interpretaciondelpatrimonio.com/docs/Jornadas%20AIP/IVjornadas/LuisaMaria.pdf> (accessed 23 Feb 2008)

Greaves B. (2006) "Presentación studio control y seguimiento medioambiental de la cueva de santimamiñe" Spain
http://www.bizkaia.net/Home2/bizkaimedia/Contenido_Noticia.asp?Not_Codigo=4383&Tem_Codigo=4&Idioma=CA

Kam,T., (1997) "Synthesis of Finite State Machines: Functional Optimization". Kluwer Academic Publishers, Boston.

La Pensée, A. (2004) "Non-Contact Recording and Replication of Cultural Heritage" *Building Conservation Director*.
<http://www.buildingconservation.com/articles/replication/replication.htm> (accessed 13 Jan 2008)

Tarini,M., Cignoni P., Rocchini, C.,and Scopigno, R. (2000) "Real Time, Accurate, Multi-Featured Rendering of Bump Mapped Surfaces" Computer Graphics Forum (Eurographics Conference Issue), Blackwell Publishers.

Tatarchuck, N,(2005) "Practical Dynamic Parallax Occlusion mapping",Siggraph.<http://ati.amd.com/developer/SIGGRAPH05/Tatarchuk-ParallaxOcclusionMapping-Sketch-print.pdf>

Wagner, F., (2006) "Modeling Software with Finite State Machines: A Practical Approach", Auerbach Publications p 64.

6. ACKNOWLEDGEMENTS

I would not want to hold any of anyone who has directly and indirectly collaborate to carry out this project. Our team who has hardly worked in this project during long hours to finish the project in time and without all of them it would never be possible: Unai Baeza, David Moreno, Endika Ibañez., Mikel Silvosa, Jose Vazquez, Ibon Zulaika, Ruben Gonzalez, Iñaki Kintana, Jon Alegría, Iñaki Ruiz and Aida Otaola. We are particularly indebted to the members of Biskay Provincial Council who bet on Virtualware and on our technology. I don not want to forget and thank to my colleagues Unai Extremo and Alvaro Barrios.

STREET GAMES: PRESERVING CULTURE THROUGH GAMING

D. Polydorou^a

^a School of Arts, Brunel University, Uxbridge, London, UB8 3PH – doros.polydorou@brunel.ac.uk

KEY WORDS: Visualisations, Game Engines, Real Time, Virtual Reality, Digital Culture, Street Games

ABSTRACT:

This paper outlines the idea of representing aspects of a cultural heritage using a game engine. The use of game engines in the field of cultural heritage is not something new. Currently they are commonly used to recreate important historical sites as well as record and represent infrastructures and artefacts in various exhibitions and museums. This project concentrates on a certain aspect of cultural heritage, the games that children used to play in the streets. The aim of this project is to digitally recreate an old 1950's Cypriot traditional neighbourhood and give the user the ability to navigate and interact with the people and the surroundings. Special emphasis will be given to the street games that young children were playing at the time. There will be instructions and tutorials on how each game is played, accompanied by visual representations. Furthermore, the user will be able to play the games.

1. INTRODUCTION

Street Games is a work in progress that aims to support the preservation of historical memory and Cyprus tradition through state of the art technological means. This short paper outlines the steps which were followed to facilitate the creation of an interactive game aiming to educate its audience. This project explores the effectiveness of a game engine to record, manage and deliver cultural history in a fun and inventive way. It provides the audience a way to remember old traditions and interactively re-live them in an immersive environment.

A big part of a country's cultural history, lies with the custom and traditions of its people. It is inevitable that because of urbanization, the changes in the social infrastructure and the technological advancements many of those traditions will be lost. This project concentrates on the variety of games and activities that children used to perform in the streets. By recreating a virtual Cypriot traditional 1950 neighbourhood it gives the user the opportunity to explore it, interact and hear stories from the residents and learn and play games with the children in the streets. The final game aims to be used as an educational installation in an exhibition place, like a museum. This paper includes a summary of the research background, an overview of the engine used and the methodology used to create the game.

1.1 Background Research

Using interactive 3d real time visualizations in the field of the preservation of cultural heritage has become an important tool worldwide. A number of research institutions have been recently exploring the possibility of using game engines. Reconstructions of whole civilizations from the past have been made and easily displayed to the public due to the process's non-intrusive nature. Digital Songlines, an Australasian CRC for Interaction Design, developed protocols, methodologies and toolkits to facilitate the collection, education and sharing of indigenous cultural heritage knowledge, by using the Torque Game Engine (Wyeld, 2007). The Foundation of the Hellenic World (FHW), a non-profit cultural heritage institution, uses VR technology to create immersive, interactive and photorealistic experiences using a framework based on OpenGL (Gaitatzes, 2001).

1.2 Street Games

As part of the data collection for the projection, information had to be collected on the different traditional street games. Unfortunately, apart from some small villages who still try to keep some traditions alive, these games are almost completely abandoned by children throughout Cyprus. Finding any books on the subject proved to be much more difficult than expected. Information therefore had to be collected from the memories of the people who experienced them. Luckily enough, it wasn't too late and everyone who was asked was more than happy to provide a detailed account of how the games were played. The survey undertaken included 20 randomly selected persons, 10 male and 10 female, in the age range of 45 – 85, who also accepted to evaluate the game after completion. As expected, almost no account had identical rules since a lot of these games rely on the creative improvisation of the people who played them. What follows is a choice of four of the most famous games suitable for being used in the project.

1.2.1 Lingri: Setting up this game is very simple. All you need are two pieces of wood, one about 40cm long and 3cm in diameter which you name "the lingri", and another one around 75cm long which you name "the lingra". You then place "the lingri" on two rocks which are 20cm apart. The player then, using the "lingra" launches the "lingri" into the air, and tries to hit it again and sent it flying as far as possible before it falls to the ground. The winner is the person who manages to get the "lingri" cover the furthest distance.

1.2.2 Skatoullika: To play skatoullika, all you need are around 12 flat stones. One person piles the stones on top of each other and stands at a safe distance around 5m behind them, facing the stones. The rest of the players, stand around 10m away from the stones, in a line, again facing the stones. When the game begins, each player in turn throws a rock at the pile, aiming to knock it down. If the pile is knocked down, or if the players have thrown all of their rocks, they quickly have to go and recover their rocks. The person who stands behind the pile, at that point, must quickly re-pile the rocks, and then touch one of the other players before they manage to return to their original position. If he/she is successful, then that player takes his/her place as the person behind the pile.

1.2.3 Vasileas: This game is slightly more complicated and time consuming to set up. By using a piece of chalk or if unavailable lots of small stones, you create on the ground a cross like shape divided into six boxes. The player then throws a rock in the first box, hops in on one foot, picks up the rock, and then hops back out. Then the rock must be thrown on the second box and so on until all boxes are covered. The aim of the game is first of all to throw the rock in the correct box and then manage to hop in the boxes and recover the rock by following correctly the previously predefined path and all these without touching any of the bounding lines.

1.2.4 Sakoulodromies: This game is a 50 metres race, with a twist. All the participating players have to get inside a big potato sack, which covers their legs and torso. That means that once the race starts, the players must hop all the way to the finish. Not as easy as it sounds.

2. GAME VISION

The aim of this game is to give the audience the ability to navigate and interact in a reconstructed 1950 Cypriot neighbourhood. The player will navigate in the streets, where he will meet different groups of children, each group playing a different street game. The player will then be able to approach and talk with the children, learning the history of the game, how the game was introduced into the culture, how the game is played and finally even have a go at it. Apart from the groups of children, the player during his walk around the neighbourhood will also come upon some other people, each doing their daily traditional chores. By talking with each of them, information about the history of the place can be uncovered, as well as about the countries customs and traditions.

After consideration and research on game analysis, it is decided that a third person camera will be used instead of a first person one. The reasons for that lies to the fact that inexperienced players might find first person view more confusing, therefore giving up playing the game altogether. By being able to look at the character you are controlling, like in the third person view, players can see and more easily comprehend what each key press is doing.

The game needs to be quite simple in order to be accessible to as many people as possible including people with no experience in computer games. It also needs to offer educational value and of course be fun enough to keep people interested. It is not meant to be a long game, rather short enough for someone to experience it fully in one visit to its exhibition space (that being a museum or any other place).



Figure 1: Vasileas

3. GAME ENGINE FEATURES

In order for a suitable game engine to be identified for the project, a number of them have first been evaluated (Unreal Tournament 2, Ogre and Torque). Panda3d, an open source engine developed by Disney, was chosen as it contained most of the required features. Firstly, there is no license fee in order to use the engine. It works with python bindings, which means that development is much easier and faster and finally it has a very active and helpful community.



Figure 2: Vasileas alternative Camera

3.1 Standard engine features

Panda3d creates a 3 dimensional visualization environment that supports the importing of 3d models. By the use of scripts, behaviours can be assigned to these models thus creating a user interactive experience. The basic scripts are included in the engine, like for example functionality for controlling a 3d character in the scene. The creation of the environment can be completely made in the 3d package and be ready to use when imported into the engine. Basic AI, network support as well as an impressive array of peripheral support (joystick, VR Gloves etc.) are also present. Unlike other game engines, since development is in python, testing out your code is very fast and very easy since no compiling is required.

3.2 Modelling

Modelling is an integral part of any game. Most of the models in this project, like for example the neighbourhood, have to be developed from zero in order to follow the designers artistic views. However, since creating 3d models is a lengthy process, at the beginning of the project an extensive search was undertaken in order to find/purchase some suitable support models. Before a model is created, a range of appropriate pictures of the object are collected and analyzed in order for the modelling technique and the proportions to be established. Since the game will not be developed having in mind top of the range systems, the polygon count of the models must also be taken into consideration. Please note that all the models used in the displayed pictures are models found online, used for testing purposes and are not the final models.

Models are developed in Maya, by using the traditional polygon method. Videos or pictures might be used as a backdrop, giving some guidelines to the artist on the general shape. This process is not limiting to the artist, since he has the artistic freedom to deviate from the references. When the modelling, animation and texturing finishes, the models are then exported as an .egg file (the panda3d native file type). This is done through a Maya

plug-in that comes with Panda3d. It is best to note here, that Panda3d has available plug-ins for most of the popular 3d-packages (Maya, 3ds Max, Blender, Soft Image among others).

3.3 Artificial Intelligence

Artificial Intelligence defines the way that the models behave in the created world, trying to give them a sense of intelligence. A good AI system can make the difference between a successful game and an unsuccessful one. In order to make this clearer, let's take a simple example. We want to create a scene, where the player will navigate in the virtual neighbourhood and comes across a housewife hanging some wet clothes out in the sun to dry. We will then want to add some kind of interactivity in the scene. The player will be able to have a short conversation with the housewife, who when asked, will tell the history of the village.

The first thing which must be done is set the path and actions that the model will follow over time. Eventually, if the player just sits there and watches the housewife will release that she is repeating the same tasks over and over. This is unavoidable, since she is playing an integral part of the story, so she needs to stay there to offer something to the player. This is common game practice. By setting the paths and actions that the model will perform (for example putting some clothes to dry) you are giving to the model some very basic AI. The second step will be to add interaction. When the player clicks on the housewife, a script which will start a dialogue will be initiated. That script will tell the model to stand still, and according to the dialogue options respond accordingly.

Compared to contemporary games, this is of course a very simple AI logic, but due to the nature of the game is adequate. Panda3d has ready built in classes which can be used to set up the paths and the collisions, proving the basic AI which is required for the project.

3.4 Other features

The engine, being further developed by Carnegie Mellon University, has now a lot of new and interesting features integrated into it. As this project might be considered for a Virtual Reality installation in a museum, the computer and user interaction element of the game needs thorough investigation. Panda3d has built in support for keyboard and mouse, as well as joysticks VR Helmets and sensor trackers.



Figure 3: Bird's eye view Camera

The addition of network support for the game might be a nice idea for future development and Panda3d has classes for supporting networks. There is a built in support for easily integrating client-server connection, as well as for transmitting data over network protocols.

4. LOGIC AND IMPLEMENTATION

The way the engine is set up allows for a rapid and inexpensive development of a 3d scene. Models (in the egg format) can be imported straight into the engine both as static collision models (the environment) as well as kinetic actor models (the avatars that will animate during game play). The models are arranged in their starting position, and then simple scripts are called (python bindings of readymade C++ classes) to code the different levels of interactivity. A virtual camera is created and always looks at the main avatar, following his every move to provide the player with a way to visualize the world, as well as built the necessary identification with the character he will be controlling during his immersion in the game. Keys are then assigned to the x,y,z movements (left/right, forward/backward, jump) of the avatar in order to provide navigation. The left mouse click is also assigned for action. The next step would be to set up collisions with the environment. For the static models, this is actually done inside the 3d modelling package, by creating polygonal shapes around the desirable objects and assigning them a collision tag. For example if a house is created, a polygonal collision tag model will have to be created that is identical with the walls of the house. That means that whenever the player comes near a wall, a collision takes place which prevents the avatar from passing through. A collision sphere will have to be created for the avatar as well, which is done inside panda3d, by calling a script.

When everything so far is set up correctly, the player has a 3d space where he/she can roam around freely, with working collisions. The next step would be to add some Artificial Intelligence. All the Non Playable Characters (NPCs) are assigned a predefined path to move around. This is done by calling a single class, which all the actors will inherit from. Then a separate class will be built up upon that, to give uniqueness of action to each actor. After this task is done, the 3d space is populated with models going around doing their business. Setting up the lighting at this point would be a good idea, so you can get a good feel of how the game will look closer to completion. A good lighting is absolutely crucial for giving out the right mood.

The next step would be to create interactivity between the NPCs, the environment and the player. For the scope of this game, triggering interactivity will be achieved by two different ways. The first and most common one in most games is by clicking on an object. A script will be set up, which checks if the mouse button is pressed when the cursor is over an object (by sending a collision ray) and if the result is true, an event will be triggered. The second method, which is most commonly called an area trigger, will check if the player is in the vicinity of a specific area and perform the event. This can also be created with collisions, by setting up a script which triggers an event as soon as there is a collision between the player and the boundaries of the predefined area. Before the game will be taken into the testing phase, the music and the sound effects are added as well as any animation/videos (in our case the street games tutorials).

5. TESTING AND EVALUATION

As soon as the first version of the game is ready, the next step will be a thorough evaluation. It needs to be evaluated both for its content as well as interface, functionality, how easy/difficult it is and of course it's fun value.

Considering that the progression of the game will be monitored by a museum or an educational institute, the contents will be evaluated by a group of experts appointed by them. The comments will then be taken into consideration, changing accordingly the narrative aspects of the game.

Evaluation of the interface, functionality, difficulty level and fun value must be done by a mixed group of gamers and non-gamers of all ages. One suitable venue where the testing might be undertaken is in elementary schools, under the supervision of a teacher, since the game can be classified as an educational game. The game is trying to attract the older generation as well, so feedback by an age group of over 45 is equally important. The same people who provided the information about the games have already agreed to evaluate the game.

6. CONCLUSION

Creating an educational game is a fun and inventive way to promote the preservation of a country's culture. The game targets the younger generation by offering them alternative and more approachable ways to learn than books and films. Children nowadays are growing up with a much different technology than that of their parents. Video games are an integral part of their daily life. Incorporating educational values in gaming can make children view the content in a different perspective, as it is now part of their world. It also introduces new technologies to older generations by portraying familiar and nostalgic content to them, encouraging them to set aside their "fears" and try out the game consoles of the new generation. The whole experience can act as a bridge between the two generations, offering better communication between a parent and a child. Children might even be encouraged to go out in the streets and with the guidance of their parents try out some of the games. Furthermore, the project if used appropriately can act as a way to bring the Greek and the Turkish Cypriot communities closer to each other. Most of these street games are common to both communities, and in fact they have been playing them together in the old days, which can act as a proof to our shared customs and traditions. The game is still a work in progress. By following the game design documented created for this project, the general idea and the software foundations are ready, as well as enough art work to start a testing phase. Offering the final game to be part of a cultural exhibition can be a way to attract more people to it, especially in a country where gaming is an undeveloped industry. When the game is finished, the software developed can even be easily adjusted to produce further work visualizing other aspects of cultural heritage not limited only to Cyprus, but to an international level as well.

7. REFERENCES

References from Journals:

G. Gaitatzes, D. Christopoulos and M. Roussou, 2001 "Reviving the past: Cultural Heritage meets Virtual Reality", VAST2001: Virtual Reality, Archaeology, and Cultural Heritage.

Theodor G. Wyeld et al., June 2007. *Doing Cultural Heritage Using the Torque Game Engine: Supporting Indigenous Storytelling in 3D Virtual Environment*. International journal of architectural computing Issue 2 volume 5.

References from Books:

Byrne, E. 2004. *Game Level Design*. London: Charles River Media.

Choi, J., 2004. *Maya Character Animation*. 2nd edition. London: Sybex Inc.

Dawson M., 2006. *Python Programming for the absolute beginner (second edition)* US: Thomson Course Technology.

Freeman D., 2004. *Creating emotion in games*. US : New Riders Publishing

Kondo, K., 2005. *Discover the Game with Alias*. London: Sybex Inc.

Miller, C., 2004. *Digital Storytelling: A creator's guide to interactive entertainment*. Oxford: Focal Press.

References from websites:

Panda3d., 2008 wiki manual, http://panda3d.org/wiki/index.php/Main_Page (accessed 15 May 2008)

Python.,2008 Python reference manual, <http://docs.python.org/ref/> (accessed 12 April 2008)

NEW NARRATIVE TECHNOLOGIES: A DIALECTICAL APPROACH. SPEAKING TO - CALLING FOR - TALKING ABOUT

A. Spagnoli

Politecnico di Milano, Milano, Italy - spagnoli.ale@gmail.com

KEY WORDS: Narrative technologies, Talking territory, New paradigms, Dialogue, Participation, Connective atlases, 2.0 rooms

ABSTRACT:

"Territory as text" is the filter-concept that interprets the relation cultural heritage/ICT/user: it is a speaking text composed of tangible and intangible cultural goods, with readability and strong narrative vocation. In this context, complex cultural heritage should be regarded as artifact that need to communicate and be communicated: the aim of the designer passes through the problem of understanding, communication and fruition of the good itself, to get the identification and construction of scenarios within which contesting and materializing some of the endless possible stories that the territory itself contains. From a critical analysis of the use of new technologies applied to the valorization of cultural heritage, carried out through the investigation of case studies, emerge three different narrative/dialogic approaches to the theme: in the first case the cultural heritage arises the need to "speak" to the user (using as first paradigm the linguistic action of "claim") in the second case is the user who "interrogate" the cultural heritage (overturning the terms relationship to the paradigm of "question"), finally, in the third case, the users "talk" to each other within the context of cultural heritage ("dialogue" as a paradigm of sharing and production of historical memory). Such dialectical movements allow to suggest scenarios (connective atlases and 2.0 rooms as a means of participation and collaboration) within which new technologies could aim at territorial capital's valorization.

1. NEW NARRATIVE TECHNOLOGIES'S OVERVIEW

The context to which the paper refers is that of cultural goods as cultural and territorial capital, as a network of signs and values that mean the past, the history of a place and its community. Within this complex system, cultural heritage assumes importance not only in its conservation and protection but especially when it is valued and therefore enjoyed by the community.

From few decades, new technologies got in contact with this context of preservation and valorization of goods (or systems of goods) bringing added value: high technology, and innovation always connected to it, have introduced new parameters to watch and move in view of spread, accessibility and use of cultural goods.

The discussion focus on the relation cultural heritage/individual mainly from the viewpoint of fruition. Fruition is generally linked to two distinct and complementary areas: the show, which presupposes the use of architecture for the exhibition, permanent but increasingly ephemeral (Polano, 2000) and the narration, which presumes knowledge, and consequently, communication "outwards", by the artist/work/place you're dealing with (Gabrielli, 2005).

These two practices, which can rightly defined inseparable (in the sense that if by one hand the practice of exhibition cannot be separated from a descriptive/narrative intention, on the other hand the practice of the story must, with even non-traditional means, be "putting on stage", therefore setting) are originated both from the strongly narrative vocation of territory and goods. Story can therefore be regarded as the common denominator capable of guiding every action of exploiting territorial capital.

The aim of the paper is to propose new scenarios of application of new technologies to cultural heritage, through a dialectical analysis of their development; this analysis is scanned into three

stages and it is often synchronic over time. The survey was conducted through the analysis of international and Italian case studies (to be considered as interesting best practices) that have virtuously applied the potential of ICT to enhancing cultural heritage.

A critical analysis of these experiences reveals three different narrative/dialogic approaches to the topic: in the first case cultural heritage arises the need to "speak" to the user (for example, in many cases of audio guides and virtual museums); in the second case is the user who "interrogate" cultural heritage (that is the case of telematic systems of travel planning using principles of mass customization); finally, in the third case, the users "talk" to each other within the context of cultural heritage (innovative examples of sharing and production of historical memory). Such dialectical movement (which uses as first paradigm the linguistic action of "claim", then supplementing it with "question", to complement the paradigm of "dialogue") implies some directions and potential towards which the new technologies should lead. The metaphors of connective atlas and of 2.0 room can be considered useful tools to enhance cultural heritage within a highly collaborative and participatory scenario.

2. TALKING TERRITORY

In the territory are visible and tangible signs of human behavior, traces of time, tracks that are the basis of a collective historical memory, more or less clearly perceptible. Cultural good as "witness means of civilization" (definition proposed by the Commissione Franceschini, 1967) and territory as collector and container of systems of goods, are at the same time incubator and producer of value.

Most of the surface of the earth is a huge deposit of knowingly signs left by those who have gone before us: cities, villages, houses and huts, roads and paths, canals, tunnels, dams,

divisions of fields and plantations. The places that we observe are the result of a long process of cumulative selection, still in progress. Continuously, in connection with these places, through a process of perception, recognition and knowledge, we give meaning and symbolic value to what surrounds us: in some cases, these values consolidated over time; in others it is necessary to discover and bring to light new hidden meanings. The immense archive of material signs left on the territory by ourselves and others before us (heritage are the backbone of this archive) is the result of a continuous accumulation of this process of allocation of meanings.

The reading keys used for the interpretation of the territory are in constant evolution: by the principle of layering, to palimpsest, to the concept of hypertext; from each one of these metaphors transpires the image of a territory as "container" of stories, whether legible or illegible, vehicle of signs and meanings, and therefore of communication.

The territory condenses the alive and pulsing body of a community, with all its contradictions and its driver forces, but the territory has also its specific individuality: this individuality cannot be read only in the light of the present, without its history and its complex stratification. According to Paola Cannavò the understanding of the place comes through reading this layering, with a necessarily historic footprint: "The territory is saturated with signs, evidence of large drawings, fragments of structures which had a strong meaning when they were drawn and that today, erased by new signs or integrated into other places, have lost their original meaning [...]. We need to read the traces of time in the territory, identify those not easily visible, understand them in their fragmentation and complexity, based on their incompleteness the research of the sense of places." (Cannavò, 2004)

The concept of palimpsest, which partially replaces the concept of layering, is another reading key of the territory. The image of palimpsest (Corboz, 1998) made glimpse a process of construction of places like continuous work, in which traces of the past are constantly reused for new purposes, and where transformations carried out an objective of adaptation compared to background sedimentations. Considering construction as accumulation and overlap of signs, it is possible to switch to an idea of interpretation.

In the end the metaphor of hypertext introduces a further leap of interpretation. The hypertext, in its definition applied to information technology, consists of a network of related information united in a non-linear and only partially default order. These units can have heterogeneous nature: text, sound, images and video. The user, as active reader, freely carries out their own paths to reading within the meta text. The hypertext perfectly fits the image of a discontinuous and personal reading, a reading managed by jumps and combinations that an active user (who transformed himself from reader to author and creator of connections) leads against the territorial capital.

In this context, cultural heritage, always within its specific context, can be analyzed from a semiotic point of view as an out-and-out text. In fact it has the main features of the text:

- The territory is a text, etymologically a fabric or rather a network of meaning elements in relation each other. This is clearly a complex text, stratified, variable in time and space.

- It is also a living text in continuous transformation, never identical to itself, which preserves traces of eminent past but rewrites tirelessly in every part, although at different pace.
- In the different mobility of its various aspects is easy to see stratification, not only a hierarchy of importance but also of meaning. Territory is an extraordinarily rich and complex text, which poses enormous problems of design and interpretation.
- Each presence, each manufactured, each color, smell, writing, each building says its membership in competition with other presences and inscriptions. There is a conflict, which is first of all semantic, realized not only at the level of individual messages but also of codes.
- It is a "war of interpretations" of material writings, but also of different looks, that captures and uses different aspects of the same text. (Barenghi, Canova, Falcetto, 2002)

Through the filter of semiotics Umberto Eco already identified cultural phenomena as facts of communication: cultural heritage, as individual messages, organizes and becomes understandable in reference to certain codes (the structure and thus the context within which are included). (Eco, 1968) Cultural good is therefore to be considered as "artifact" which, on one hand need to communicate (because without this communication does not trigger fruition's process) and on the other hand need to be communicated (the main area of valorization).

In this context, the practice of storytelling, in whatever form and by whatever tool it is structured, has assumed a role of paramount importance in the relation cultural good/user. It can be regarded as the substrate in which all active projects around the theme of valorization revolve. Storytelling as a tool that translates and makes comprehensible the communicative vocation inherent in any cultural "artifact"; storytelling as a choice designed to clarify one or more of the endless stories that the cultural itself contains; storytelling as a means to put into scene an "open history", because the communication is never finished when arrives at the recipient, in this case user, but is completed only with a re-interpretation. New technologies are therefore the new connecting diaphragm between two worlds (cultural heritage and community) through which making stories, tales and meanings flow.

3. THE RELATION CULTURAL HERITAGE/USER: A DIALECTICAL MOVEMENT

Digital revolution and the resulting research and innovation, has introduced a very strong acceleration in all relations with the cultural good: from organization of cultural facilities to resource management, from valorization processes to fruition tools. The promotion of ICT (as telematic networking technologies, multimedia systems, three-dimensional graphic, digitization of cultural heritage) have so far operated on a dual track: the transformation of cultural institution, which has acquired new tools for preservation and administration of its assets, and the change of mode of use, which tends increasingly towards an "expanded use" whose key word is "accessibility".

The theme of accessibility, and before of reproducibility, was already analyzed in the '30s by Walter Benjamin, who was the first to recognized the potential of reproduction of artistic work, for its wider accessibility, and so spread, while maintaining the

essential concept of uniqueness of the work itself. It has been previously stressed that cultural good is an object that communicates to its recipients, so this is not possible, within a process of valorization, irrespective of its expressive intention: the act of communication is realized only if the work of art, the system of goods and the territory reach the recipient.

Technological innovation will be understood as essential opportunities to support the diffusion of culture and the spread of knowledge, research, education and dedicated information. (Granelli, Tracò, 2006)

The study of some experiences, international and Italian has highlighted a sort of synchronic development, divided into stages clearly identifiable, of the relationship between new technologies and cultural goods. The cases, considered as best practices in this area, are deliberately analyzed in the eyes of use and fruition than conservation, in step with the reading of narrative vocation of cultural heritage. The analysis is defined "synchronic" because the speed of ICT and the strong gap of ICT implementation by the various institutions allow only partially to find a defined timing, in favor of a contemporary development of different approaches.

The first narrative/dialectic approach identified takes into account the need for cultural good to "talk" to the possible user, a necessity closely related to the communicative nature of good (and even more system goods): the cultural good, to be fully perceived as a source of historical and collective memory, needs to convey its meaning outside of itself, to tell, to be understandable, therefore useful.

The second approach reverses the terms of the equation: in this case is the user himself who "interrogate" cultural good, the will of understanding and knowledge leads him to ask the meanings, to understand connections with the context and with other systems of goods and to seek investigation. In this way emerges a clear willingness to receive personalized information (and consistent with user's profile) to which the cultural itself is called to respond.

The third approach, sum and overcoming of the others, as exactly happens in the dialectical process, refers to a new scenario in which users speak, interact, "discuss" with each other within the context of cultural goods. This type of approach highlights a "participatory" difference against former and, therefore, can be considered as the scenario in which hypothesize, and consequently design, new instruments of interaction between ICT and user finalized to an "enlarged" fruition of cultural goods, not just in terms of accessibility but especially of active participation (Figure. 1).

3.1 Speaking to paradigm: from hyper-technological to hyper-anthropocentric

Within the first movement, which uses as its paradigm the linguistic action of "claim", may be included all those experiences that exploit the potential of new technologies as a (semiotic) tool through which convey the message from cultural good to recipient. The user, as recipient, hears understands and assimilates the story proposed. The reworking of this message, well conveyed, implements user's stock of knowledge, thus increasing the added value of cultural fruition.

These examples, here schematically analyzed, show how the practice of storytelling can take several forms and very different

content depending on the context in which it forms and especially of how the message/meaning affects the structure of communication.

Racconta storie is a project developed by the University of Palermo, Italy; this is a shell, apparently abandoned on tables of bars and restaurants, within which was inserted a microphone capable of responding to external stresses: when the shell moves the microphone is activated and begins to tell stories about culture, art and traditions of Palermo territory. The metaphor of the shell that encloses sea noise has been used to exacerbate the emotional and fascinating aspect of cultural fruition. In this case the technology is regarded as purely anthropocentric: it is obvious the effort to make it invisible, and also the will to remove any type of grammatical and technical interaction between technology and users.

The second case is the Museum of Resistance of Massa Carrara, Italy, inaugurated in 2000. The museum has a not simple goal: conveying memories of a past still full of emotion and illustrating the "not illustrating". In fact this memory of a Resistance is not only partisan but also of peasants, of deported, of population struggling for survival. The museum is built around a "table of memory" divided vertically by a screen: while on the table are projected virtual brows able books, on the screen, in sync with the contents of books, running interviews and testimonials of the period. The cornerstone of museum's fruition is the merger of oral tradition through the use of modern technologies, use in this case expressly warm, emotional and narrative.

Ename 974 project is an example of user-oriented application of ICT in the context of archaeology. The archaeological areas (in this case a series of excavations around Ename, today Oudenaarde, located in the province of East Flanders) can be compared to a story in which there are torn pages, whose reading is uneven, sometimes even incomprehensible. In the case of Ename, technology combines the need for preservation of the finds with the need to make usable the site through its complete virtual reconstruction: virtual reality facilitates learning reproducing the methods of visual communication. The use occurs through immersion in a virtual environment indistinguishable from the real, constructed in such a way to deceive the perception and create the conviction to interact with reality, and through the use of highly interactive and customizable multimedia presentations. The obvious problems, connected to the understanding of archaeological sites by a non expert audience, led to the development of strongly oriented narrative technologies as instruments of knowledge and contextualization.

Finally 3M, with the project Sensitive Space System, has recently developed a system of video projections that react dynamically to the movement of people without their direct interaction. These Sensitive Wall, which allows the use of multimedia content through a touch less interface, were used in 2007 during the exhibition "Space BLUe: Building across river Landscape United Europe" at Casa del Mantegna in Mantua, and "Impressions of travel. The linguistic research and ethnographic Paul Scheuermeier in Lombardy, 1920-1932" at Villa Recalcati in Varese, Italy: through the use of this new technology was possible for the public dialogue with sensitive and interactive screens, capable of breeding written information (lemmas, travel diaries, correspondence), graphics (sketches and drawings) and photographs.

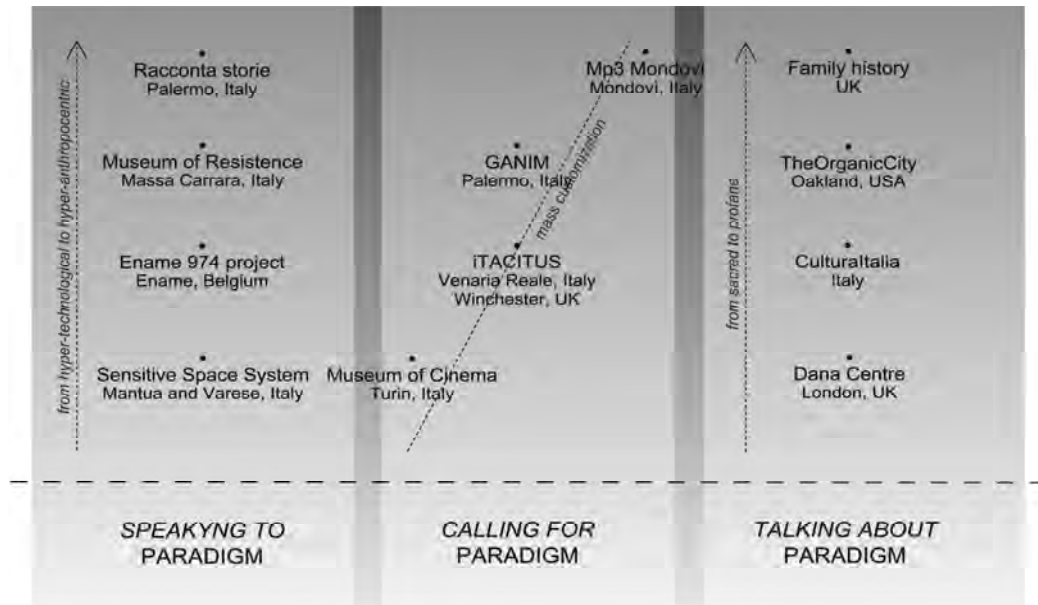

Figure 1: Display of the relationship paradigms/case studies

These four examples make a rather comprehensive overview of how territory and cultural heritage have been able to communicate to the user: on one hand it is possible to identify a clearly hyper-anthropocentric approach (the experience of *Racconta Storie*) where is the man to impose his *modus vivendi* to technology and not technology to impose its *modus operandi* to the user; on the other hand there is a hyper-technological approach (exemplified by technology *Sensitive Space System*) in which technological research is itself the bearer of innovation and new communicative content, regardless of context of application.

3.2 Calling for paradigm: mass customization

The second movement (which declines into paradigm the linguistic action of "question") refers to a context in which the users feel the need to interrogate cultural goods. The user by means of ICT has the ability to choose reading custom paths, to deepen knowledge of particular aspect of good, to calibrate languages and content according to his level of learning, to access to news and information consistent with his personal interests.

The practice of storytelling in these cases is enriched by the interaction: the individual is no longer only a spectator but intervenes directly in the communication process with good, which becomes a two-way process. The selected case studies range from multi museum to the most updated travel planning systems.

The National Museum of Cinema in Turin, inaugurated in the headquarters of Mole Antoneliana in 2000, is characterized by the use of innovative technologies to improve the communicability both in management and availability of multimedia material both in production of teaching materials. The wide range provided by the museum, which goes from collection to the multiplex, up to the cine/library, needed to high-tech testing to provide appropriate solutions to a very broad target. The project *Wireless Museum* can enjoy, with use of PDAs and wireless handhelds, multimedia content not

supported by traditional audio guides. With the use of handheld, users can access text, images, audio, video and expand the visit of some salts through a graphical interface and a hypertext able to simplify and optimize research and storage of information.

On the border between the multi museum and the planning travel systems there is *iTACITUS*, a project co-financed by the European Community and by private companies and public institutions. This is a project that spans between the development of a dynamic and customized system to provide innovative services, the travel planning and the research in the field of augmented reality. The objective of experimentation is to equip citizens with services for "intelligent" info mobility integrated with cultural information: through a system of "artificial learning" *iTACITUS* performs a specific user profile and it is able to provide information consistent with the needs of the user. In two test sites, the Palace of Venaria Reale in Turin and Winchester in London, are experimenting handhelds able not only to support customizable multimedia content but also to recognize the element to which the attention of the user stops to provide virtual reconstructions of missing objects, past exhibitions, or just anecdotes.

A similar experiment to the European *iTACITUS* is *GANIM*, a handheld developed by the University of Palermo in collaboration with *PROTUA*, that works as a mobile and interactive guide. The handheld has previously stored the user profile and when he moves closer to a cultural good that could be an object of interest emits a signal of warning: if the user's stops the handheld records the stops and starts to provide information and investigation.

One last interesting project, which will start being prototyped by July 2008, is *Mp3 Mondovì*, a system of podcasting for custom routes in Mondovì and Monregalese, Italy, developed by the Foundation *Fitzcarraldo*, the University of Turin and local actors. *Mp3 Mondovì* project uses technology to convey narratives and podcasting to resume the attractive factors of the territory. Includes: the use of proprietary devices (iPods, MP3 players and mobile phones already in possession of the user),

the application over a wide area (in this case an entire territory recognizable as uniform cultural district improving through synergistic processes); three routes by about one quarter of an hour, with audio tracks with narrative autonomy. The contents of audio tracks are returned in the form of theatrical narrative and designed ad hoc in collaboration with Accademia dei Folli, specialized in storytelling, taking into account the ever-present competition between the timing of designed fruition (in this case scanned by the audio track) and uncontrollable times of personal experience.

The cases taken into consideration, in addition to underline a new trend of the user to request services and tools to implement the acquisition of information on cultural heritage, have as their common denominator the trend of new technologies to move towards an extreme personalization. Both modern multimedia audio guides and new travel planning systems are moving towards a process of mass customization: in this way the user is led to build his profile and to receive only a few possible stories conveyed by the cultural heritage, stories designed and carefully selected.

3.3 Talking about paradigm: from sacred to profane

The third type of relation cultural goods/user is the one in which some users talk and interact with each other within the context of cultural heritage; in this case the paradigm of reference is the "dialogue". Using the metaphor of Hegelian dialectics, the third paradigm not constitute as a simple sum or as an overrun of the first two paradigms, but as their reconciliation, to achieve a form of fruition in which the individual is a truly active element in the process of acquisition and construction of knowledge.

There are not many examples in this sense and for the most part are the first experiments using the channel of the Web as a privileged means to emphasize the continually in progress and potentially innovative character of new technologies.

The portal *CulturaItalia* (www.culturaitalia.it), born within the "Technology Observatory for cultural goods and activities" on the Italian Ministry, is an experimental project running from April 2008: this is a portal of content and services for the user that using the principle of "aggregation" of resources of Italy's cultural heritage through the interoperability of cultural databases. It then tries to encourage the digitization of resources in the country and to organize these resources within the same platform. The challenge of the portal is to transform each user from consumer to contributor, from passive user to active author of content, shifting the focus from platform/website to network. At the other, its already foreseeable limit is the wide target; the attempt to structure around the portal a meta-community implies a highly collaborative vocation: without content providers, whether they are cultural institutions and ordinary citizens, the project wasting and dies.

A project consciously oriented to storytelling is the portal *TheOrganicCity* (www.theorganiccity.com) that explicitly calls to send, via Web, stories and tales (in format of text, audio and video) that revolve around places, traditions and culture of the city of Oakland. The materials sent are subdivided by format, inserted into categories (horror, noir, adventure...) and placed geographically within the city map. While a breakdown by gender stresses the desire to circumscribe the target to authors who have familiarity and expertise with forms of narrative production, on the other hand the amount of published material

(with the video section minority compared to others) leads to reflect on the amount of attention and availability that the web requires, as opposed to what the user is willing to grant.

Family history (www.bbc.co.uk/history/familyhistory) is a section of the BBC portal that promotes inclusion by the British citizens of commentaries, tales and stories of personal life. The objective of this portal is the strengthening of a collective national consciousness, relying on a process of identification and participation of citizens to the evolution of English history and, indirectly, the construction of an immense historical archive with high cultural value from absolutely non-institutional sources. The "active" participation in the project, seen by discrete amount of material sent, and "passive" one, track able by confluence of visitors-viewers on site, highlights the potential for new projects, while addressing a very generic target, to allow the individual to put in play experiences and personal memories.

The last case study is the virtuous example of Dana Centre, new area of the London Science Museum opened in 2003. The Dana Centre, unlike the trend followed by almost all the museums of science and technology that are intended for young audiences, decided to ask explicitly for adults, mostly unskilled. The extreme attention to target has influenced the entire museum's organization, from schedule of content to communication. The Dana Centre is so structured as a real and virtual forum in which scientists and citizens can meet and talk supported by a packed calendar of events and conferences which could promote scientific debate. In addition to physical cultural center there is also a web section which supports a "4th room": a virtual space without limits of capacity in which held discussions on science. As a matter of interest it is the will of the centre to establish a true community: users talk and interact each other through avatars.

The last group of experiences highlights a recent development of highly participatory and collaborative fruition's tools. All these examples have a common risk: if the whole project is based on the active participation and involvement of the users, when the participation is missing, the project fails and disappears. On the contrary, when there is a great participation, the project becomes automatically a best practice for the valorization of a specific cultural context.

It is also interesting the breadth of issues: from personal memories to digital content of cultural significance, from stories and traditions of a city to scientific topics. From sacred to profane: the sacred, as the major purely cultural area, in which the intervention of sector operators is crucial (in cases of *CulturaItalia* and Dana Centre) and the profane as activities of non-expert users who are able to give contributions and personal cross to the theme of cultural experience (in cases of *Family history* and *TheOrganicCity*).

4. CONNECTIVE ATLASES AND 2.0 ROOMS: NEW SCENARIOS OF INTERACTION

From the previous analysis, storytelling emerges as the instrument behind all the practices of fruition of cultural capital. It takes shape in various forms: from the recited story of cultures and traditions of a place to the reconstruction of a virtual missing reality, from the roundtable able to activate the debate to multimedia hypertext.

New technologies are involved in this field by making instrumental and formal innovations, but above all by “approach” innovations. ICT makes possible the use of different languages from traditional ones (content otherwise declined to reach different target), the creation of space-time links (entering the system of cultural goods in a broader context), and not least the introduction of new and flexible content (multimedia and updating as the most exploited characteristics of ICT). Forms and tools of the story multiply, content disclaim codes and languages in full consistency with the instrument through which they conveyed.

In this context, complex cultural goods are regarded as artifacts that need to communicate and be communicated, and require the design of the whole process of communication: from the choice of one or more of the endless possible stories (the contents of the message) to the choice of codes, media and languages to convey the message from sender to recipient.

The aim of the designer, called to pass through the problem of understanding, communicating and improving the good itself, is to get identification and construction of scenarios within which context and materialize some of these endless stories that the territory itself contains. Meaning with scenario (in the definition of Manzini, Jégou, 2004) “an overview of something complex, caught in its (actual or possible or imaginary) transformations.”

The analysis of the experiences of valorization of cultural capital and the identification of the three paradigms (speaking to/calling for/talking about) allows detection excerpts, in the characters of talking about paradigm, of a possible evolution of the relationship ICT/cultural goods/user.

In particular, potentially practicable roads seem to be two: connective atlases, strongly linked to tradition travel planning guides, and 2.0 rooms, as enlargement of the possibilities offered by the linguistic action of dialogue.

Connective atlases refer the wide world of guides, maps, and unconventional charts, eclectic atlases for their ability to collect and make system of heterogeneous and often irreconcilable content. Connective atlas as travel notes, diary board in “geographical” form able to connect information, insights and comments, and to share personal suggestions using a unique platform; evolution of traditional travel planning guides, in which “density” of collective interest towards a particular good replaces the principle of creating functional-user profiles: serendipity as the value added to the practice of travel.

An experimental example that uses the principle of connective map declined in a context other than that of cultural heritage is the PdPal Turin, active from 2006 Winter Olympics. This is a digital map of the city of Turin (on web but also downloadable from normal GSM devices) in which citizens and tourists can tag neighborhoods, streets or buildings of public or private interest, according to a principle of two-way exchange of information.

2.0 room as a platform that combines together the features of social network and cultural information portal.

Social network as a network of individuals interconnected with one another, able to exchange information, to use codes and shared languages, to increase its stock of knowledge activating link-network, strongly participatory and equally collaborative.

At this moment network as MySpace, Facebook, LinkedIn are having a large spread, demonstrating the willingness of people to invest much of their time on the web (the exchange of content, more or less personal, always requires an investment in terms of time and “fatigue”).

Cultural content portal to highlight cutting content: very sector focus, for example certain areas of cultural heritage (the scientific disclosure in the case of Dana Centre) or recognizable as cultural districts (Mondovì and Monregalese) are not limited to the possibility of achieving a broad target. The participatory and collaborative nature of this type of network needs a strongly interested community, in a sense “motivated”, willing to work in construction and exchange of information on cultural content.

Scenarios, connective atlases and 2.0 rooms, run the same acceptable risk: when the cultural institution intervenes only upstream (and that is in the process of creation and activation of the platform) the life cycle of communication exchange is solely left to users: the user is responsible not only of the exchanged content but also of community’s vivacity or tear.

5. REFERENCES

References from Books:

- Barengi, M., Canova, G., Falchetto, B. (by), 2002. *La visione dell'invisibile*, Mondadori, Milano, pp. 150-158.
- Bertola, P., Manzini, E. (by), 2004, *Design multiverso. Appunti di fenomenologia del design*, Ed. Poli.Design, Milano, pp. 193-194.
- Breschi, A. (by), 2005, *Musei non solo*, Alinea editrice, Firenze.
- Cannavo', P., 2004, *A_TRA_VERSO. Inseguire la trasformazione*, Mandragora, Firenze, pp. 158-159.
- Carta, M. 1999, *L'armatura culturale del territorio*, Franco Angeli, Milano.
- Cassatella, C., 2001, *Iperpaesaggi*, Testo&Immagine, Torino.
- Celaschi, F., Trocchianesi R., 2004, *Design & Beni culturali*, Ed. Poli.Design, Milano.
- Ciotti, F., Roncaglia, G., 2001, *Il mondo digitale*, Laterza, Bari.
- Corboz, A., 1998, *Ordine sparso*, Franco Angeli, Milano.
- Eco, U., 1968, *La struttura assente*, Ed. Bompiani, Milano.
- Fiorani, E., 2005, *I panorami del contemporaneo*, Lupetti, Milano.
- Granelli, A., Traclo', F. (by), 2006, *Innovazione e cultura*, Il Sole 24 Ore, Milano.
- Polano, S., 2000, *Mostrare*, Lybra Immagine, Milano.
- Turri, E., 1998, *Il paesaggio come teatro: dal territorio vissuto al territorio rappresentato*, Ed. Marsilio, Venezia.

ISEE: ACCESSING RELEVANT INFORMATION BY NAVIGATING 3D INTERACTIVE VIRTUAL ENVIRONMENTS

L.Pecchioli^{a,b,*}, M.Carrozzino^{a,c}, F.Mohamed^d

^a IMT Lucca Institute for Advanced Studies, Lucca, Italy

^b Technische Universität Berlin, Institut für Geodäsie und Geoinformationstechnik, Berlin, Germany -
laura.pecchioli@gmx.de

^c PERCRO Scuola Superiore Sant'Anna, Pisa, Italy – marcello.carrozzino@sssup.it

^d Humboldt Universität, Berlin, Germany – fawzi@gmx.ch

KEY WORDS: interactive 3D interface, ICT, AR, XVR 3D engine, normalised gaussians, spatial relevance, overlap

ABSTRACT:

The aim of the work described in this paper is to develop a novel approach to access and manage information through an interactive 3D interface, with a particular attention to Cultural Assets data management. The research is focused on investigating a method to connect information to specific “zones” of 3D Virtual Environments. The system makes use of an interactive 3D model reproducing the main features of a corresponding real environment. An original aspect is provided by our definition of “spatial relevance” of information, which allows users to retrieve significant information according to their position/orientation in the 3D space. In order to allow access to a wider audience, the system is accessible through an intuitive and user-friendly interface on normal Web browsers. The system has been applied to selected case studies related both to outdoor and indoor environments, proving potentially to be also an interesting prototype as a smart guide with the use of augmented reality technologies.

1. INTRODUCTION

Cultural Heritage ICT applications often involve the massive use of several types of information in different formats and from different sources, and it is often very easy to produce lots of data in a short amount of time. It is therefore evident that efficient organization techniques are necessary in order to manage data and to present it to the public, whether it is general audience or specialised users. Internet has deeply changed the way we use to organise data, but an integrated management method targeted to Cultural Heritage needs is still missing.

GIS technologies are being increasingly used, in fact in our case studies we had to deal with lot of data like images, ortho-photos, texts, already referenced with geographical information. Although a common geographic reference system often represents a valid key to read and access data, the 2D kind of interaction provided by GIS software is often limiting.

The aim of this work is to bring the information closer to everybody. Using the sense of sight is part of the human natural behaviour since the birth; looking at something we implicitly set the focus on a part of the world, therefore we identify a context.

In this paper we present a method to approximatively define the focus region, the *View Zone*, and use it to retrieve a measure of spatial relevance that can be used to return useful contextual information. This way we set a simple common language that most of the people can quickly understand, and which they can use to explore, query and learn. The complexity dictated by type of data becomes simplified in a few gestures.

ISEE is a prototype software developed in order to give access to information having a connection to places in the real world and which we plan to apply also to electronic guides in an AR (Augmented Reality) environment, as it is inherently based on

visiting and exploring 3D environments with the possibility of getting information in real time.

Our approach, based on natural interaction, has required to set up methods for a quick filtering of the information and the use of a synthetic 3D model. The user can freely navigate and explore an interactive virtual model and “query” the portions which he is interested in.

The use of an intuitive ranking function lets the user automatically find relevant information just looking around. A good pre-filtering allows to effectively manage a high density of data in the 3D environment.

The possibility to acquire, process and analyse geographic information, without the need for installing proprietary GIS software or having deep GIS knowledge, has been taken into account in this work. Although the approach of ISEE is focused on creating an interface for the general public, it is meant to be used also by professionals involved in the Cultural Heritage field (Pecchioli et al, 2007a-c).

Recent developments have opened new horizons for 3D visualisation and today computer technologies are capable to handle, process and manage large amounts of visual data. Moreover, in latest years there was a big spreading of portable devices (like PDAs, mobile phones, car-computers), distributed wireless network connections (GSM, GPRS, UMTS, WLAN, Bluetooth), and localisation technologies (GPS, Wi-Fi and cell tower triangulation,...), that provide means to create interactive environments anywhere, with the user being able to take advantage of novel technologies to access information services. One of the latest and more successful Web services is related to mapping technologies, the most famous being without doubt Google Maps. In general these services focus on outdoor navigation with 2-D maps, however recently 3D environments,

* Corresponding author.

as simulated sights of urban areas (as in Google Earth), are gaining a growing success.

An interactive experience with the context is often very important, and when dealing with ubiquitous computing it must be taken into account that the user's context is very dynamic (Dey, 1999). An interesting approach based on the combination of realistic views with location specific information, using handheld devices like PDAs and cellular phones, is proposed in (Kolbe, 2004). The application uses video clips, realised by recording both walking directions of paths in pedestrian areas, augmented with location-based information.

A prototype of a 3-D guide system has been presented in (Takashi, 2007). The pilot study was conducted in the Science Museum of University of Columbia. The positioning system was realized using a dead-reckoning method, which detects the user position/orientation using a self-contained sensor module (three-axis accelerometers, gyro sensors and magnetometers). The visual interface is based on a monocular HMD (Head Mounted Display).

In (Spohrer, 1999) an interesting example of an hand-held device NaviCam is presented, which recognises tagged objects and then overlays context-sensitive information (Rekimoto, 1998). The system is based on the use of a hand-held display system or of a see-through augmented reality approach.

2. THE ISEE DATA MANAGEMENT METHOD

It is clear that if information is attached to 3D portions of a Virtual Environment, the definition of a 3D *zone* is crucial. We decided to associate information not directly with logical features of the 3D model (like buildings, monuments or other distinctive components), but rather with approximated 3D zones which can be defined as "general" portions of the 3D space. Each information owns its 3D zone which we call *Information Zone* (IZ). This kind of linkage has the advantage of not requiring the subdivision of a 3D model in logical sub-elements to attach information. In this way it is possible, for instance, to directly use meshes generated by 3D scanners, without the need of any particular data post-processing in order to identify sub-portions of the models. The indirect connection with 3D objects has also drawbacks:

- it is not always easily possible to find exactly information related only to a given object;
- queries can be less precise;
- replacing the 3D model with a new version (for instance, a more precise one) can make the transfer of information tricky if the level of detail of the 3D zone is comparable with the error in the 3D model.

2.1 The gaussian function

Now the question is: how to represent these approximated zones? One of the simplest 3D objects is the sphere, as it requires only two parameters, radius and centre, to be described, so it is quite easy to define it also interactively. However a sphere, like any other solid object, has a sharp boundary: a point is either inside the sphere or outside it. In the real space the behaviour of boundaries is not so "distinct", especially when dealing with open spaces, so defining a smooth transition at the zones boundaries would be preferable. We decided to use a gaussian function (Figure 1) for this purpose. A

3D gaussian is a function which assigns a value to each point of the space (it can be seen as a fog, more dense in the center, and less dense on the periphery), which can be used to adequately describe the "concentration" of information. There are several interesting advantages linked to this choice:

- the 3D gaussian function is very simple to define;
- it has a continuous behaviour (like a charge distribution);
- it has a computationally efficient representation.

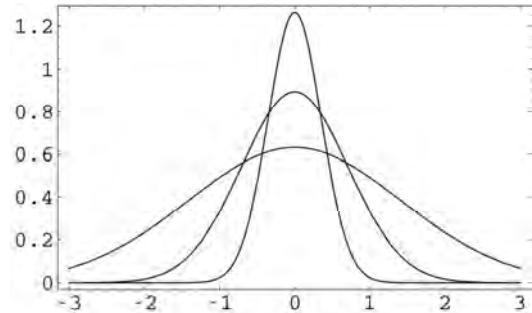

Figure 1: Plot of normalised gaussians with different widths.

The IZ is therefore realised associating information with a 3D gaussian centered on a relevant point of the object which we want to link the information to, and with a width comparable with the object size. It is important to note that the gaussian is not used to define the exact information location, but rather an approximated zone which can be subsequently used to search and retrieve the information. The amount of information is not connected with the size of the gaussian, which depends just on the size of the object. A priori, all gaussians should represent the same amount of information independently of their size. The use of a continuous distribution nicely solves this problem: gaussians are normalised and, while a sharp gaussian is smaller than a loose one, it also has a higher concentration so that the total amount of information is the same (Figure 1). In the current stage of development a more precise definition of the zone can be stored in the information data itself. In the future one might directly support more complex zones.

The portion of the 3D model which is being looked at in the interactive 3D Viewer (*View Zone* - VZ) is also approximated with a normalised 3D gaussian, so that View Zones and Information Zones are described similarly. The symmetric treatment of VZs and IZs let us use the interactive 3D viewer to visually insert the IZ of a piece of information (authoring), or to "jump" immediately to the view related to some information (retrieval). The gaussian that represents the View Zone is built as follows:

- the center of the gaussian is chosen on the point P , representing the first intersection between the 3D scene and a ray casted from the current point of view towards the center of the view plane. Basically you "shoot" a ray in the direction you are looking: P is the point where your ray encounters an object.
- The width of the gaussian is chosen proportional to the distance of the center P from the view point, so that it is similar to the size of the viewed area (Figure 2a and Figure 2b). The angle of the view cone is constant, and the closer the object is, the smaller is the width, so that the perceived dimension of the VZ on the screen is constant, but its real size is depending on the distance from the object.

2.2 The Spatial Relevance of Information

An innovative aspect of this approach is represented by the definition of “spatial relevance of information”. Intuitively, the relevance of information should be maximal when its Information Zone (IZ) coincides with the Viewed Zone (VZ), decreasing when they are far apart. Moreover, as information is always associated with extended zones rather than with points, we can also use the size of a zone to decide if it is relevant.



2a)



2b)

Figure 2a: Interactive 3D Viewer with the VZ represented as a central green sphere.

Figure 2b: Interactive 3D Viewer with the viewing zone VZ represented as a central green sphere and the IZs represented as the two other red spheres.

An IZ that has a size comparable to the current VZ is probably more interesting than an IZ that has a size different from the current VZ. Using the level of detail of information is a big advantage when dealing with high densities of data. To implement this we need a precise definition of relevance.

Given two normalised Gaussian g_A and g_B with width σ_A, σ_B and centered in R_A, R_B

$$g_{A,B}(r) = \frac{1}{(2\pi\sigma_{A,B}^2)^{3/4}} \exp\left(-\frac{|r-R_{A,B}|^2}{2\sigma_{A,B}^2}\right) \tag{1}$$

then the overlap between them is

$$S_{AB} = \int g_A(r)g_B(r)dr = \left(\frac{2\sigma_A\sigma_B}{\sigma_A^2 + \sigma_B^2}\right)^{3/2} \exp\left(-\frac{|R_A - R_B|^2}{\sigma_A^2 + \sigma_B^2}\right) \tag{2}$$

As it can be seen in Figure 3 the overlap S_{AB} is maximal when the two gaussians coincide ($R_A = R_B$ and $\sigma_A = \sigma_B$) and gets smaller if the IZ is far away or very differently sized.

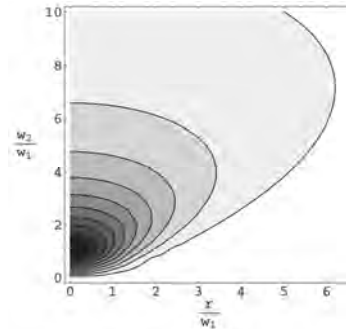

Figure 3: Contour plot of the overlap of two normalised gaussians with width “ w_1 ” and “ w_2 ” and a distance “ r ” between the two centers. Darker means a higher overlap.

Therefore we can use the overlap between the gaussians VZ and IZ as a measure of the relevance of the information connected to the current view. This allows us to associate a continuous level of detail to the information. When browsing the data using this measure of relevance an ordered list of the most relevant information of the selected area (Data List) related to the VZ is built and visualised following the schema in the Figure 4.

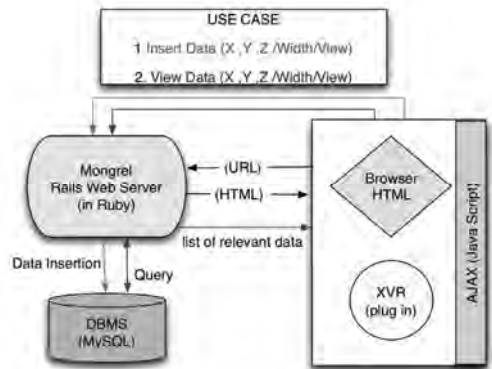

Figure 4: Interaction scheme for the use cases of ISEE

3. INTERACTING WITH ISEE

The graphical user interface of ISEE is simple, intuitive and user-friendly. We have chosen to use commonly available tools which can work through the Web too. The interaction is based on the traditional WIMP interface (Windows, Icons, Menu, Pointers), with the notable feature of a window containing a 3D view of the virtual model representing the information environment. In order to visualize and interactively navigate the model on the Web, we used the XVR technology (Carrozzino et al, 2005), jointly developed by PERCRO Scuola Superiore Sant’Anna in Pisa (Italy) and VRMedia s.r.l..

The 3D model is interactive and can be freely navigated; there is also a 2D map view which can be used to move around and identify the surroundings. The spatial context of the query is interactively definable on the 3D model. The idea is to dynamically produce, while the user is moving, a list of the information relevant for the current View Zone. This list can be

filtered with keywords too. When a data set is selected, related extra information is shown below: if the user double clicks it, a Web browser window with meta-information and access to the original data is provided.

The 3D model is downloaded on the user client as soon as the user access the Web page. As soon as the download is finished, a first list of information automatically appears, presenting on the top the most relevant for the zone the user is currently looking at. The content of information is visualised on a side window (Figure 5). On the bottom-right a horizontal label shows the geographic coordinates.

ISEE allows to perform the following operations on the information stored:

- to query and search
- to visualise
- to modify
- to compare and have an high level overview of the data present
- to add new data.

Using data relevance depending on location-based information, although effective and interesting, does not assure that the amount of retrieved information is not overwhelming. Therefore, a more traditional way to restrict this amount is advisable. This is achieved using keywords filtering.

Keywords are user defined *tags* organised in a hierarchical way and should describe interesting properties for the documents. The documents have stored in one or more tags as for example: *image, restore, orthophoto...*

Each keyword has a description which an authorised user can insert, edit or destroy along with the related entry.



Figure 5: The browsing interface of ISEE

At any moment when the user is navigating the 3D model, he/she can select one or more keywords from the hierarchical list that appears selecting "Filter Keywords".

Immediately the information that is displayed in the list of relevant documents is filtered and only the documents that match the current selection (and are relevant to the portion of model one is looking at) are displayed. Their use is similar to the tags in flickr (<http://www.flickr.com/>), their effect is more interactive, as during browsing they immediately take effect.

3.1 Web pages structure

ISEE is structured in several Web pages as shown in Figure 6. When logging in to ISEE, a user is assigned one of three different levels of access:

- a first level user can visualise and navigate the model and perform queries;
- a second level user can access authoring tools;
- a third level user has also administration privileges.

In the Home page the user can:

- access generic information (without entering the interactive mode)
- choose a case study selecting the related link (entering the interactive mode Browse Docs);
- see informative Videos;
- consult the Help.

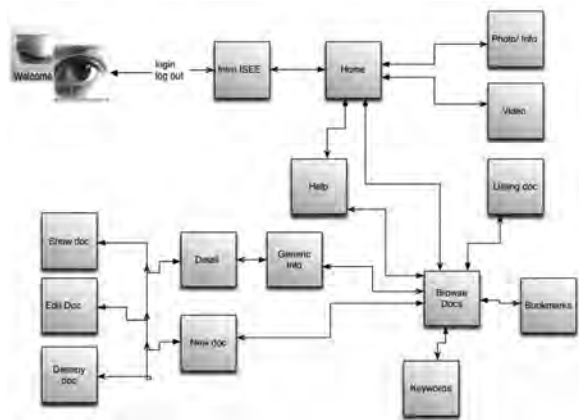

Figure 6: Pages flow

Browse Docs is the core of the ISEE application. Inside this section, the user can navigate the 3D model and use the ISEE access metaphor to retrieve information.

An item list allows to retrieve further details (Detail) for each information found (and jump to its related View Zone), and provides also (if the user has enough privileges) the interface for authoring operations. Moreover, in Detail the user can look for the source of the information with the Archive Fonds command.

From the Browse Doc page the user can also select filtering keywords (Filter Keys), list all documents (List Docs) related to the selected case study, (still to implement) consult pre-defined views (Bookmarks) and consult on-line help. Depending of the user's access level, he/she can also modify/ add new documents, keywords and bookmarks.

4. THE SMART GUIDE PROTOTYPE

In this section we will discuss some preliminary considerations on case study applications of ISEE as a smart-guide.

We tested ISEE on-field using a GPS Compass (Vector CSI Wireless), providing 2D heading and positioning data connected to a laptop in Piazza Napoleone in Lucca, Italy (Figure 7).

Piazza Napoleone is a beautiful square placed in the center of Lucca in Tuscany. There are many different related data pieces dealing with historical, artistic and architectural information describing the evolution in time of the square. Documentation is available in form of photos (*jpg* and *tiff*), maps (*shapefile*, *dxf*, *dwg*), 3D models (*3ds* and *dwg*) and text, coming from different sources like libraries, archives, public offices and foundations in the cities of Lucca, Pisa and Florence.

The geo-referenced 3D model of Piazza Napoleone in Lucca was created using information from topographical data, including the real heights of buildings.

The goal was to demonstrate the usability of ISEE in order for a user moving in a certain context to access and see related information in real time. The prototype allows the user to move in the real environment and provides automatically the most relevant information related to the portion of the world he/she is looking at. This is achieved by translating the GPS data in the reference system of our 3D model, so as to realise an exact overlap between the real and the virtual environment. In the first experiment we used a really cumbersome prototype, because of devices availability reasons, making use of a notebook and of a large GPS device (Figure 8). The application was successfully implemented and we were able to retrieve information by just looking around.

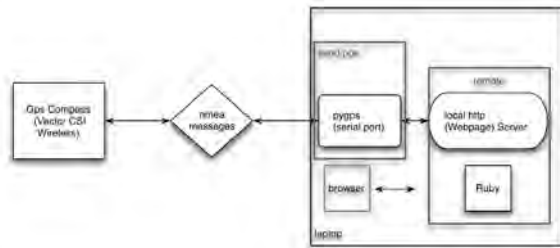

Figure 7: Control flow for the use case of ISEE with an external GPS



Figure 8: ISEE prototype

5. CONCLUSIONS

We presented an intuitive and user-friendly interface to access the information in a 3D space. The association of the information with general 3D zones allows an immediate use of

3D data coming from various sources. Our proposed ranking method copes well with high densities of information and, together with the symmetric treatment of view and information zones, enables an intuitive interface. Some possible developments of the method could involve:

- MuS's is another application of ISEE, currently in progress. So far it consists in a simple virtual museum of art. In a real museum an ideal system would automatically detect the visitors position and orientation and, depending on that, it would display the content following ISEE criteria. This prototype can represent an interesting step in future indoor applications. Indoor environments may have a more complex topology and present additional difficulties for the application of ISEE related to the presence of rooms, i.e. closed small spaces, possibly connected with openings. In the first prototype we started with a simple case of two rooms (Figure 9);
- using CityGML with ISEE. CityGML is an attempt at building a standard model for the representation of 3D urban environments, and it treats not only geometric but also semantic information (Kolbe, 2006). Such a model can be the basis to exchange information between various systems, and allows to realise specialised 3D GIS applications. In our method it can be used to describe the partitioning of the spaces in zones and as storage format for ISEE applications. We plan to use CityGML and ISEE in a couple of virtual settings: a museum and a street in Berlin.
- After the feasibility test, we would like to improve the smart guide prototype with the use of state-of-the-art portable devices. A touch screen, for instance, would allow a more natural interaction, and the latest generations of handheld devices integrate several of the needed components, like the GPS receiver. Open issues are related to the integration of pointing mechanisms (needed to retrieve the orientation) and to the poor 3D performances of these kind of devices, although it is expected in the next future a major improvement on this aspect.
- We are going to test the case study of Piazza Napoleone in Lucca with the use of immersive mixed reality technologies (like for instance retinal displays) with the collaboration of PERCRO laboratory of Scuola Sant'Anna in Pisa (Italy).



Figure 9: MuS's interface with information detail

6. REFERENCES

- Carrozzino, M., Tecchia, F., Bacinelli, S. and Bergamasco, M., 2005. Lowering the Development Time of Multimodal Interactive Application: the Real-life Experience of the XVR project. In: Proceedings of ACM SIGCHI International Conference ACE 2005, pp. 270-273.
- Dey, A. K., and Abowd, G.D., 1999. Towards a Better Understanding of Context and Context-Awareness, GVU Technical Report GIT-GVU-99-22. College of Computing, Georgia Institute of Technology, Atlanta, USA, pp.304-307.
- Kolbe, T., 2004. Augmented Videos and Panoramas for Pedestrian Navigation. In LBS & TeleCartography, G. Gartner, Ed. Geowissenschaftliche Mitteilungen, vol. 66, 2003, pp. 45-52
- Kolbe, T.H and Bacharach, S., 2006. CityGML: An open standard for 3d city models, Directions Magazine, The Worldwide Source for Geospatial Technology.
- Pecchioli, L., Mohamed, F., Carrozzino, M. and Leitner, H., 2007a. Accessing Information through a 3D Interactive Environment. In: International Cultural Heritage Informatics Meeting (ICHIM07), Proceedings: J. Trant and D. Bearman (eds). Toronto: Archives & Museum Informatics, Toronto, Canada.
<http://www.archimuse.com/ichim07/papers/pecchioli/pecchioli.html> (accessed 30 Sep. 2007)
- Pecchioli, L., Mohamed, F., Carrozzino, M. and Leitner, H., 2007b. Method to link Data in 3D environment. In: Proceedings of the International Conference CAA2007, Computer Applications and Quantitative Methods in Archaeology, Berlin, Germany.
- Pecchioli, L., Leitner, H., 2007c. Managing information in Cultural Heritage using a 3D interface. In: Proceedings of the International Conference ICOM2007 - CIDOC, Vienna, Austria.
- Rekimoto, J., Ayatsuka, Y., and Hayashi, K., 1998. Augmentable reality: Situated communication through physical and digital spaces, Wearable Computers. In: The Second International Symposium on Wearable Computers, Pittsburgh, PA, pp.68-75.
- Spohrer, J.C., 1999. Information in places, IBM Systems Journal, Vol. 38, no.NO 4., pp.602-628
- Takashi, O., Masakatsu, K., Nobuchika, S., and Takeshi, K., 2007. Control, automation and systems, In: International Conference - ICCAS '07, Seoul, Korea, pp.749-753.

INFORMATION SUPPORT SYSTEM FOR MUSEUM ON BASE BLUETOOTH TECHNOLOGIES

A. G. Finogeev^a, V. A. Maslov^a, A. A. Finogeev^a, K. A. Bukin^a

^a Dept. of Computer Aided Design, Penza State University, Krasnaya Street, Penza, Russia, 440026
- finogeev@sura.ru

KEY WORDS: Information Support, Bluetooth technology, Location Based Service, Remote Control, Virtual Museum Exhibitions, Audio Tour System

ABSTRACT:

The article describes the project, which purpose is a development of the multi-objective system for information support of the museum visitors by means of cellular telephone and Bluetooth technologies. The basic idea of the project is concluded to provide the user's cellular phone or communicator by audio-visual information under its finding in access zone. The system allows, to define the visitor's position in museum, get information, as well as allows use a cellular telephone as a remote control unit.

1. INTRODUCTION

Cultural and natural heritage applications have proved to be an attractive vehicle for researchers. Several projects have developed data collection tools, museum or city visitor guides as a means of demonstrating various concepts including location and context awareness and smart building environments. To date, most demonstrator applications in the cultural and natural heritage areas have concentrated on data collection systems and on various forms of visitor guides.

Currently, many big museum has a "personal electronic guide" system which is based on a device, similar to a telephone, with a keyboard and an earphone: when the visitor wants information on a specific work of art, she/he types the "artwork number" on that device and then listens to the information requested. Most heritage-oriented systems have typically been based around a single class of user terminal device. In a few cases, specialized devices have been developed to address limitations of commercial products. This kind of system, does not present an adequate flexibility needed to take into account the peculiar differences of people visiting the museum.

Such systems are usually adjusted only on delivery of the necessary information up to the visitor and do not give to it an opportunity of a feedback with information museum system, for example visualization and management of the virtual 2D pictures or 3D models, Web presentations and virtual museum exhibitions. In our project it is offered to connect two directions within the universal integrated system of information support and remote control of virtual models and presentations (Finogeev, 2006) or real models by the equipped microcontrollers which will allow the visitor not only simply to receive any information, but also to become the interactive participant of a virtual museum exposition, directly to operate its elements for careful research and learning.

2. REQUIREMENTS

Sharing information requires a suitable communication technology, which preferably should be wireless in order to be in line with the unobtrusive nature of the devices. Various

companies are already working to extend wireless technologies that will seamlessly connect to others nearby devices. The technologies used are mainly short range infrared, ultrasonic or radio signals for indoor applications, such as museum guides, and outdoors, Global Positioning System (GPS) receivers have been widely used for data collection and urban visitor guides.

The communication technology must be robust, scale well, and must efficiently use the limited energy of the autonomous device. Finally, the communication technology employed should adhere to a broadly-used standard to leverage from existing communication services in the environment. However, so far no single communication technology has established itself in the field of ubiquitous computing: many wireless communication technologies seem to lack robustness, consume too much energy, or require an infrastructure to be viable candidates

We decided to take a closer look at the emerging Bluetooth standard as a potential candidate, in our opinion, it is the most suited and it is wide-spread. Today most portable device has a built-in Bluetooth module and no additional hardware is needed. Bluetooth is used to link the user device to access points spread around the premises, and to carry the text and graphic information, the streaming MP3 audio and commands for governing object virtual presentation. The technology by way of its use for data transmission on a cellular telephone and PDA on short range distance with speeds sufficient for multimedia applications practically supersedes IrDA.

Bluetooth is an emerging communication standard that provides ad hoc configuration of master/slave piconets including eight active units at most. Bluetooth operates in the license free ISM spectrum and uses frequency hopping spread spectrum to minimize interference problems. Advantages Bluetooth is that meanwhile was developed as a low power, low bandwidth, low price, short range application for connecting a variety of devices together, inexpensive, system does not require line of site (works in crowded situations) [Cano, Manzoni, Toh, 2005]. The use of Bluetooth means that when the design of the user device goes into production it will be small, inexpensive and able to operate for many hour without recharging. Certainly use

Bluetooth technologies (BT) assumes initial expenses for purchase, programming and installation units in the museum.

3. RELATED WORK

There is a large number of research projects coping with the problem of seamlessly providing tourist information (Fockler, 2005; Bay, 2005; Bruns, 2007) but they concentrate on the problem of assisting a tourist during visit to a museums, thus providing information on interesting objects and helping in planning tourist itineraries.

Another research project (Ciavarella, 2006.) uses infrared beamers placed each one at the entrance of each museum room, thus user localization is performed by detecting in which room she/he is present. The client software running on the handheld device can show the map of the room providing the user with information regarding the artworks in that room.

Next work (Cavalluzzi, 2004.) is presented a multimodal, user friendly, virtual guide for specific contexts. The aim is to build a system adaptable to the user needs of mobility and therefore usable on different devices. In this manner computing device can replace human assistants like museum guides. It is possible to build ad hoc applications in according to context and user needs obtaining customize interaction.

This paper (Verikoukis, 2006.) presents the use of Bluetooth technology to provide support for context-aware applications. A wireless museum server based on Bluetooth technology in order to offer an interactive electronic guidance for museum or exhibit halls' visitors is next analyzed. The described solution is a nice example of Information and Communication Technologies application in culture.

A museum or gallery audio tour system using BT technology has been successfully demonstrated at the Melbourne Museum. Bluetooth enabled audio tour system is designed to combine the best features of broadcast and CD/tape tours.

4. OBJECTIVES

The objective of research project is realizing the system of personal information support and remote control for a museum's visitor. The museum's visitor should have an opportunity to use own mobile communication device (cellular telephone, palm-computer, communicator) for access to museum information space, mining of the necessary information and remote control of various objects.

The system should carry out following basic functions:

1. Detection and identification of a mobile communication unit at its hit in a access zone concerning Bluetooth dongle
2. Retrieving by user's inquiry text, graphic or audiovisual information on a wireless radio channel by means of stack of Bluetooth protocol
3. Support of a feedback for a possibility of interactive remote control by the electronic equipment, program applications or a virtual reality objects and to adjust cellular telephones on performance of various actions with program applications, virtual reality objects, electronic household units etc.

The system should support following services:

1. Service of localization of mobile units. It is intended for automatic detection, recognition and identification of the mobile device on a power level of a radio signal at its hit in corresponding access zones of information space
2. Service of personal information support. Allows the user to retrieve by inquiry the necessary information for him after passage procedures of registration and identification of the user's devices
3. Service of remote control. It is intended for replacement of standard infra-red remote controls by a mobile communication unit with the program clients what have been adjusted for management by program applications, virtual presentations and objects, the computer, presentation ant office equipment, etc

Realization of the project will allow museums to raise attendance and attractiveness of museums and cultural exhibitions, providing new media for information on items, offering new experiences and better service for visitors.

For achievement of the given purposes system should to have a multi-agent architecture which, given that the visitor is able to locate position in the museum, provides the visitor with the information related to artwork, to give to the visitor an opportunity to operate virtual presentations, devices of visualization and other technical devices, for example various technical virtual or real models.

5. ARCHITECTURE

The overall network architecture is based on the cooperation of an wireless network and wired museum network. The wireless network is solely based on the Bluetooth technology (BT) used by mobile devices. The museum network is based on the integration of a Ethernet local area network and a wireless personal area network to connect mobile clients. The architecture is includes of a server with localization subsystem, information support subsystem, remote control subsystem and client, which is loading into user's device (Figure 1).

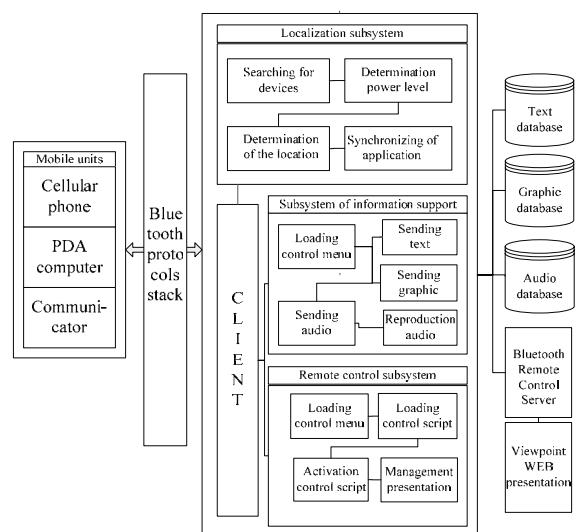

Figure 1. System's architecture

The HTTP server contains all the museum web pages related to the museum tour.

The wireless part of system include independent smart Bluetooth access points, which should carry out following functions:

1. Definition and recognition of visitors mobile devices which appear close artworks, or near to the device of visualization or real models,
2. Loading on the user mobile device the clients mobile agents,
3. Transfer of the information to the visitor depending on an opportunity of its mobile device and its requirements,
4. Activation of the remote control agent and the user interface for management of virtual presentations.

The access points provide each visitor radio connection to the local network and are wired connected to the museum local area network and to the Bluetooth nodes. The museum Ethernet network connects all the access points with the central server. User localization is performed by using Bluetooth sensor placed near each artwork, while information is provided by Bluetooth access points (Jason, 2005). The system handled the Bluetooth hardware and software for the exhibit device transceiver and the user Bluetooth device.

6. RECOGNITION AND LOCALIZATION

At each access points, a BASH program that interfaces with the Host Controller Interface (HCI) layer of the Bluetooth stack runs as a Remote Method Invocation (RMI) server awaiting incoming queries from the central server. At that nodes the BASH-script, which with the set periodicity scans a radio access zone adjoining to the device for detection accessible mobile devices of the communications by means of standard utility HCI tool is installed. Mobile BT devices periodically deliver signals with the information on a transmitter power level. The access points obtain the given signals of the devices which are being its access cell. The access point supports queries that scan the bandwidth, connect, disconnect, switch roles, and retrieve the RSSI, TPL and LQ values from a device of interest.

Further the script starts the client application which requests the positioning server, and in case of the positive response passes the data received from scanning BASH script. The server processes the received inquiries, ranging them on power of the signal received from transmitters in a cell. The program application counts radiuses of cell, in which at present time objects of identification are located, makes their recognition to hardware addresses, which are registered at the first hit of the mobile device in a cell and in the further are stored in a server's database. For storage address tables and other data in a positioning server class BtDevice is used. Each object of a class stores the device's address and parameters of a signal from each device.

Further the typical script of system's reaction on hit of the mobile client between borders of corresponding cells is determined. A cell's borders where at present time there is a cellular telephone are determined on a level of RSSI value (Received Signal Strength Indication), which is given by means of LMP (Link Manager Protocol).

In Figure 2 border of cells are designated by continuous black lines, and values RSSI are resulted on the right. Borders join in the bottom access zones. The dark dashed line designates conditional borders of cells, which turn out by shift of usual borders on the predetermined value aside moving of object. It allows to prevent frequent change of zones at signal fluctuations in the field of border.

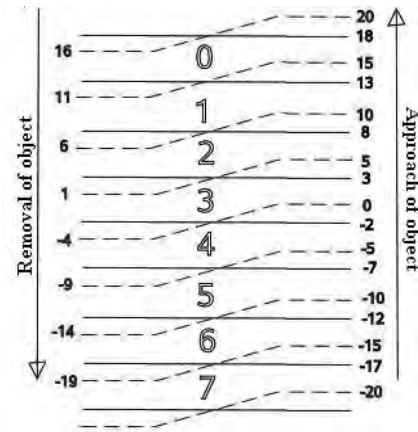

Figure 2. Border's of cells

The manager of BT connections establishes connection with managers of other clients on LMP for the organization piconet. Each manager during a session can change some times a mode of transfer a voice/data, a way of connection and type of passed packages. Parameter RSSI shows value of a difference between a level of the accepted signal and one of borders (Figure 3), so-called GRPR (Golden Received Power Range). Bluetooth devices whenever possible keep a level of an accepted signal in «a gold range», by means of periodic sending inquiries to transmitters about downturn/increase of signal's power.

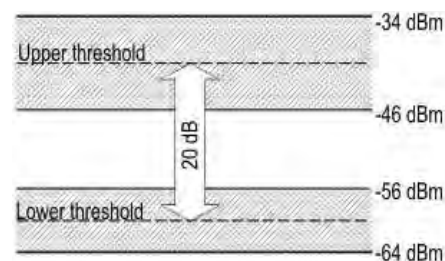

Figure 3. Golden Received Power Range

LMP allows, to receive Transmit Power Level (TPL) value, which changes with step in 4 dB and can be used for specification of a station of the traced device on in cells at zero value RSSI. LMP supports method Read Link Quality (RLQ), which is specific to each manufacturer of the equipment and returns value of link quality in a range from 0 up to 255. Link Quality (LQ) the more close to 0 is usual, than it is more than obstacles in a way from the transmitter to the receiver. But distinctions of methods of estimation LQ in devices of different equipment suppliers create complexities for its use in universal system.

The principles considered above allow formulate the basic algorithm for recognition a mobile device concerning Bluetooth access points.

1. Access points periodicity scan space in cell to search active mobile BT clients;
2. At hit of the client in a cell, it is established BT connection and the address of the device is passed to a server with received values RSSI and TPL;
3. The server processes obtained data, checks the address on its conformity to the resolved registered addresses;
4. If the mobile device has not passed procedure of registration at an entrance in a cell, its address is filtered also to the device transfer of operating influences and performance of various scripts of management is not authorized;
5. After identification the program analyzes received RSSI and compares them to top levels RSSI of concrete zones of the access defined in corresponding radiuses of action. Top values RSSI and radius of circular zones are stored in the table of differentiation together with the address table;
6. Further the application determines a provisional zone of an arrangement of the concrete mobile device concerning the stationary base station;
7. After primary definition of a station, at its movement in an operative range of the stationary base station, depending on in what side there is a change of a signal level, borders of a zone move on in advance certain size. Shift occurs aside changes of a signal level for prevention switching effect of identifiers next zones at fluctuations RSSI near to border.

Further, visitors can interactively use PDA as a private guide; choose a tour by his field of interest while reading the relevant information on each museum room at their screen and learn about the history, the author, the characteristics and other relevant details of that exhibit.

7. IMPLEMENTATION

If visitor walk into a museum, we need a BT transceiver near of every major exhibit or cultural object. Your handheld would sense the exhibits you were closest to and let you choose to learn additional information. BT network covers a specific area near museum's cultural object and provides it with a localization signal broadcasted at constant intervals. The signal is used for different purposes. For example, the position of the visitor can be evaluated and displayed on a museum map, that will allow security service of a museum to trace movement of visitors.

Location based service work by means of BT access points placed near the artworks of the museum. A different sensor is place near each artwork and it sends continuously a frame containing a unique artwork identifier. When the user approaches the work of art, he has simply receives this frame. On this basis, the client software installed on the device is able to detect the work of art the user is currently looking at and retrieve the needed information. As soon as the server receives the signal from handheld unit, it recognizes the unit near which it is located and selects the part of the database representing the information about this artwork.

In fact, the frame sent by each access point includes not only the artwork identifier, but also the information about the related art work. Since more than one user at the same time can look at the same a work of art, a single node has to serve seven user devices at time forming piconet.

Commercial BT solutions are available as self contained transceiver modules. They are shielded subsystems designed to be used as add-on peripherals. They feature an embedded CPU, different types of memory, as well as baseband and radio circuits. The modules offer a generic Host Controller Interface (HCI) to the lower layers of the BT protocol, while the higher layers of the protocol, as well as applications, must be implemented on the host system. Since the in-system CPU and memory are not available for installing user specific implementations, even a minimal standalone BT node thus needs an additional host CPU to execute applications and the corresponding higher layers of the BT protocol.

8. CONCLUSIONS AND FUTURE WORK

A client-server electronic application for the localization, guidance and remote control virtual objects for museum visitors has been presented in this paper. The system is based on Bluetooth technology in order to provide wireless data interactive transmission to museums visitors. We present an application that provides multimedia information to the museum visitors. The application combines the productivity of the Java platform with the universal connectivity of Bluetooth wireless technology.

Applications of location based services using BT may become an important entity in commerce in the future. The system assumes management of behaviour scenario for fulfillment of in advance predetermined actions depending on definition a location mobile Bluetooth devices. This technology can be used for management of electronic devices and onboard systems, for example, inclusion/switching-off of the security system at approach/removal of the mobile client, start-up of system of ignition of the engine, etc. Any mobile communication facility can be transformed in programmed universal remote controls with an opportunity of its adjustment for performance scenario of management at hit of the client into a corresponding zone of affinity concerning BT access points.

Now we are working on defining the details of each module in order to provide a prototype implementation of the whole system. Experiments made allowed us to test the localization technique and information providing through Bluetooth transmission channel, thus demonstrating the validity of the proposed localization approach. However, looking to the future, we must be prepared to deliver services to a variety of different devices, including special terminals that are beginning to replace an audio guides, but also PDA-like machines and, especially, smart phones owned by the visitors. Better solutions may be provided by application-specific navigators with ergonomics optimized to meet the user requirements, and with specifications inspired by research in context management and activity recognition, context-based usability policies and resource, space modeling, and technology convergence.

For a future work the architecture must be designed so as to allow the use of the majority of portable devices and, to this aim, it employs different technologies to seamlessly provide information to a moving user. For realization of the future systems at a wide circulation 3G phones, use is possible UMTS technology. We conduct researches in parallel in the given directions though in our opinion use Bluetooth is more preferable from the point of view of lower cost of the project as the given kind of communication does not assume additional payment by visitors of museums.

9. REFERENCES

Bay H., Fasel B., Gool L., 2005. "Interactive Museum Guide", *In Proc. Ubiquitous Computing (UbiComp)*, ACM Press, 2005.

Bruns E., Brombach B., Zeidler Th., Bimber O., 2007. "Enabling Mobile Phones To Support Large-Scale Museum Guidance" in *MultiMedia Processing*, 2007, Vol. 14, No. 2, pp. 16-25.

Cano J-P, Manzoni P., Toh C-K, 2005. "First experiences with Bluetooth and Java in ubiquitous computing", in *Proceedings Computers and Communications, ISCC*, IEEE Press, 2005, pp. 223 – 228.

Cavalluzzi A., Carolis B. De, Pizzutilo S., Cozzolongo G., 2004. "Interacting with embodied agents in public environments". In *Proceedings of the Working Conference on Advanced Visual interfaces, AVI '04*. ACM Press, New York, NY 2004, pp. 240-243.

Ciavarella C., Paterno F., 2006. "Design of a Location Aware System for Supporting Marble Museum Visitors", in *Proceedings of the EVA 2006*, Cappellini, Vito and Hemsley, James Eds, 2003.

Finogeev A.I., 2006. "System of the removed management 3D-presentations for virtual museums and galleries", in *Proceedings of the EVA 2006*, Cappellini, Vito and Hemsley, James Eds., 2006, pp. 93-99.

Fockler P. et al., 2005. "PhoneGuide: museum guidance supported by on-device object recognition on mobile phones", In Proc. Int'l Conf. Mobile and Ubiquitous Computing, Info. Processing Soc. of Japan, 2005, pp. 3–10.

Jason Yipin Ye, 2005. Location Based Services with Bluetooth. Brown University <http://www.cs.brown.edu/research/pubs/theses/ugrad/2005/jye.pdf>.

Verikoukis C., Bellmunt À., 2006. "On the design of an electronic guide for interactive museum services", <http://www.cibersociedad.net/congres2006/gts/comunicacio.php>.

EFFECTIVE USER-CENTERED DESIGN FOR THE VINDOLANDA INTERACTIVE MULTIMEDIA APPLICATION

E. Carillo, K. Rodriguez-Echavarria, R. Heath, D. Arnold

Faculty of Management and Information Sciences, University of Brighton, Lewes Road, Brighton, BN2 4GJ, UK –
(E.Carillo, K.Rodriguez, R.Heath, D.Arnold)@brighton.ac.uk

KEY WORDS: Effective Design, Museum Application, Usability Tests

ABSTRACT:

Information and Communication Technologies (ICT) applications are being employed increasingly in museums and cultural heritage sites to enhance visitors' experience and interactively convey information. Consequently, researchers and museum professionals have shown great interest in designing user interfaces which are effective in terms of learning, usability and economic outcomes. Usability evaluations are often conducted to assess the effectiveness of applications already deployed, instead of being used in the early development stages. This paper illustrates a user-centered design approach to develop an interactive multimedia application for the Chesterholm Museum at Vindolanda, Northumberland, UK. This approach is based on conducting evaluation during the design process to assess the usability and effectiveness of the future application. This paper presents the research background upon which the evaluation has been based; the preliminary analysis of the visitors' profiles that has driven the first stage of development; the methodology deployed to conduct the usability evaluations and their outcomes, which fed the second stage of the design process. During this process, interactivity, high levels of engagement and technical usability were identified as the main priorities which were later reflected in the effective design of the application. Finally, this paper seeks to highlight the potential and importance of early usability testing in ensuring the effectiveness of the resulting application.

1. INTRODUCTION

Information and Communication Technologies (ICT) and Multimedia applications are employed increasingly in museums and cultural heritage sites to enhance visitors' experience, convey information in an interactive way and entertain them.

Researchers and museum professionals have begun to show interest in assessing the effectiveness of such applications in terms of learning, usability and economic outcomes. Numerous studies have focused on the evaluation of interactive and multimedia exhibits deployed in museums and cultural heritage sites, highlighting advantages as well as usability issues.

Reviewing the published literature and informal discussions with museum professionals, suggests that the overall approach to the design and development of interactive and multimedia exhibits is still based on technology centric techniques.

Conversely, this paper investigates the application of a user-centered approach to the design and development of an interactive multimedia application for the Chesterholm Museum at Vindolanda, Northumberland, UK.

The goal of this research is to determine whether user-centered design provides an effective means of improving the usability of interactive and multimedia exhibits. In particular, this research seeks to assess whether usability evaluation techniques should be involved from the beginning of the development of ICT applications for Cultural Heritage sites.

2. RELATED WORK

2.1 Previous research

Although the evaluation of ICT applications in cultural heritage sites poses specific challenges, it has recently been highlighted

(Rodriguez-Echavarria *et al.*, 2007) that there is a lack of usability guideline specifically developed to enhance the impact and outcomes of such exhibits. Moreover, systematic studies in this field are still limited and fragmented, as they usually relate to specific case studies. Therefore, the need of specific and appropriate evaluation strategies is one of the issues raised in recent studies (Economou *et al.*, 2006).

Previous research has focused exclusively on the evaluation of ICT applications already deployed in museums, exhibitions and cultural heritage sites (Alzua-Zorbaral *et al.*, 2005; Bird, 2007; Danks *et al.*, 2007a; Danks *et al.*, 2007b; Economou *et al.*, 2007; Forte *et al.*, 2006; McLoughlin *et al.*, 2007; Owen *et al.*, 2005; Sadzak *et al.*, 2007). These studies are certainly significant in understanding the role of technology in enhancing and improving the quality of the visitors' experience and in helping to develop *ad hoc* evaluation strategies. Furthermore, they generally point out usability issues, offering interesting recommendation and feedback for future applications.

Although in software engineering practices require end-users to be engaged during the design process in order to ensure that the final product meets their expectations and that potential interface issues are detected at an early stage (Owen *et al.*, 2005), this approach is not deployed when producing ICT applications for cultural heritage. In other cases (Boehner *et al.*, 2005; Gay *et al.*, 2002), the involvement of end-users is limited to reflective design, where preliminary interviews and surveys assess mainly the expectation for the technology. Consequently, in most of the cases usability issues are observed and reported when the application is already in the museum and making changes is difficult. Common issues include exhibits too complicated to be fully utilized; tools that do not support the social dimension of the museum experience; educational applications that require the intervention of facilitators and so forth (Economou *et al.*, 2007; Pujol *et al.*, 2006).

To address these problems, this project has taken a user-centered design approach for developing an interactive multimedia application for the Chesterholm Museum at Vindolanda.

Usability experts and end-users have been engaged from an early stage of the design in order to detect interface issues and provide formative feedback on the content. The methodology developed and applied to test the Vindolanda Interactive Multimedia Application and the stages of the usability evaluation will be thoroughly described in the following paragraphs, along with the outcomes of the usability evaluation.

3. DESIGN PROCESS

3.1 Definition of the requirements for the Vindolanda Interactive Multimedia Application

The first stage of the design process involved doing a preliminary assessment of the museum's visitors in order to define a set of requirements for the application. This included a deep analysis of a visitors' survey undertaken on behalf of the museum between October and November 2007 by an independent market research agency to define the average visitor's profile. This examination has then been complemented by an evaluation of the visitors' expectations and the objectives of the Vindolanda Trust which currently runs the museum and the annex archaeological site. The outcomes of this preliminary analysis generated a list of requirements for the interactive multimedia application (Carillo *et al.*, 2008). In summary, it should:

1. Facilitate the understanding of Vindolanda complex archaeological environment by deploying 3D virtual models (Birley, 1994; Carillo *et al.*, 2007);
2. Enhance the relationship between the objects displayed in the Chesterholm Museum and the site;
3. Visualise the life within one of the earliest phases of the Roman fort and the relevance of the archaeological evidence in reconstructing it (Birley, 2004; Birley, 2005).

3.2 Design of the first prototype

The preliminary analysis briefly described above facilitated the design of the first prototype of the application. The Vindolanda Interactive Multimedia Application has been developed using Adobe® Flash® CS3 Professional.

This application aims at displaying in an interactive and engaging way one of the earliest phases of the Roman fort, the so-called Period III timber fort, and the life within it between AD100 and AD105, by combining various media and type of information.

The application is divided in three main sections, accessible from a Home Page (Figure 1). Each section is dedicated to a specific subject: 1) the Vindolanda Period III timber fort, its layout and buildings; 2) the daily life and routine of the commander in AD 100-105; and 3) the position within the Roman Northern frontier at the beginning of the second century AD.

The content of each section is thereafter divided into subsections, accessible both linearly and hierarchically, and is displayed using various media: video clips, 3D animations, written texts and pictures.

The design process has been driven by the outcomes of the preliminary analysis of the visitors' survey and the requirements agreed with the Vindolanda Trust, along with the results and observations emerged in the usability studies mentioned above.



Figure 1: Screenshot of the Home Page of the first prototype

Some elements have constantly influenced the designer:

1. Create a neat layout, conveying key information but without overcrowding the screen;
2. Make use of a consistent design to facilitate the usability and navigation throughout the application;
3. Realise a user-friendly touch screen application and therefore assure that the functional controls were large and clear enough to be easily identified and used;
4. Permit and facilitate the concurrent use of the application by small groups of people, by assuring that the size and position of each element within the screens could support such interaction;
5. Convey easy-to-understand information without being simplistic;
6. Stimulate the interest and curiosity of the users and enhance their understanding of the archaeological site;
7. Provide an enjoyable and entertaining experience for the user;
8. Produce a useful and sustainable resource to the Vindolanda Trust.

4. EVALUATION: OBJECTIVES AND METHODS

4.1 Objectives of the usability evaluation

As part of the design process of the Vindolanda Interactive Multimedia Application, the designer considered it necessary to conduct usability evaluation that could highlight interface problems as well as content issues at an early stage of its development. The need for this evaluation has been mostly generated by the awareness of possible issues, the outcomes of recent studies on ICT applications in Cultural Heritage sites and the desire to understand whether usability evaluation should be included in the development process of such devices. Therefore, the designer has decided to involve a usability expert to select a suitable methodology and undertake appropriate tests.

As already highlighted, this particular field lacks standard guidelines (Rodríguez-Echavarría *et al.*, 2007; Pujol *et al.*, 2006.), hence it has been necessary to set a specific evaluation strategy determined by the objectives and needs of the designer and, ultimately, the aim of the application.

This early stage evaluation sought to highlight primarily interface and navigation issues, in order to identify the most

appropriate modifications that would ensure that the application could be fully explored. Furthermore, it aimed at validating the design features and considerations deployed. In particular, the elements that stimulated this first evaluation were:

1. Intuitiveness of the navigation structure and the function of the buttons;
2. Layout that could allow a social use of the application and overcome disabilities (e.g. the font used is big and clear enough to be easily readable by more users at the same time and/or by people with visual limitations).

4.2 Usability evaluation methodology

The evaluation methodology defined to test the Vindolanda Interactive Multimedia Application consisted of three consecutive phases:

1. Expert Review;
2. First round of usability tests with six users;
3. Second round of usability tests with six users.

The characteristics and outcomes of each assessment will be discussed in details in the following paragraphs.

At this point, it is important to underline that this process has been developed to allow the designer to iteratively modify the Vindolanda Interactive Multimedia Application at each stage according to the outcomes of each evaluation. Therefore, the recommendations and observations made during every step have been collected and reviewed by the designer with the collaboration of the usability expert and immediately converted into modifications.

Furthermore, although the results of the usability tests are specific to the Vindolanda Interactive Multimedia Application and could not be generalised, this evaluation methodology demonstrates the advantages of a user-centered design and implementation approach.

5. EVALUATION PROCESS

5.1 Expert Review: objectives and method

The first prototype of the Vindolanda Interactive Multimedia Application was submitted independently to two experts in usability studies in order to test various elements and assets of the application and verify:

1. Interactivity: responsiveness of the functional controls;
2. Intuitiveness: easiness in identifying the functional controls and the interactive features associated with them. Also, the ability to recognize the different parts composing each screen, such as title bar, content area and menu area;
3. Navigability: ability to navigate through the screens;
4. Readability of content: capacity to clearly view the content (pictures, video clips and text) in terms of size, position and quality.

The experts were given an information pack containing a brief description of the Chesterholm Museum and Vindolanda Roman fort and the aim of the usability evaluation.

They were asked to perform three tasks and report the comments in a final report. Each task was described step-by-step and was accompanied by visual and written instructions, according with the LOGOS Cognitive Walkthrough Task

Template (version V0.2), developed by the University of Brighton.

It is interesting to notice that, even though they were expected to report the feedback in the final report, they both independently used the walkthrough for the general feedback and preferred to make comments beside the relevant screenshots.

5.1.2 Expert Review – results: The feedback gained from the two experts highlighted that the Vindolanda Interactive Multimedia Application was generally intuitive even though some buttons labels could potentially arise misinterpretations or confusion. One of the most relevant cases regarded the Home Page and the associated ‘home’ button. They both underlined that it should have been made clearer, especially in consideration of the fact that older users might be not familiar with the concept of a home page, mainly associate to website navigation. This recommendation generated a change in the design of the Home Page (Figure 2).



Figure 2: Screenshot of the Home Page of the second prototype

Both experts also underlined the need to modify the introduction, because of its relevance in understanding the content of the application, and therefore generate expectation in the users. More importantly, they suggested making it more appealing in order to engage the visitors and stimulate their curiosity. As for the Home Page, these comments induced the designer to develop a new introduction loop visually and verbally more effective and attractive.

Although other modifications were made, some of the features highlighted as potentially problematic – such as the length of some written information or the labels and colour of specific buttons – were deliberately left unchanged. This approach was considered to be preferable as it gave the designer the possibility to test them also with non-expert users.

5.2 First round of usability tests with six users: objectives, sample selection and method

The second prototype of the Vindolanda Interactive Multimedia Application was then ready to be tested with end-users. This assessment aimed at underlining mainly interface issues and verifying some of the concerns expressed by the usability experts. Therefore, the objectives of the first round of tests were similar to those that motivated the expert review. However, it was necessary to define a specific strategy to select a representative sample and conduct an effective evaluation.

Usability studies have highlighted that a critical mass of six users is needed to detect major interface issues (Nielsen, 1993). Therefore, it was considered necessary to select at least six

users for each round of trials to gain valuable and useful feedback. More importantly, the candidates were selected to statistically represent the three largest age groups of the visitors of the Chesterholm Museum:

- 19% of visitors are between 18 and 34 years old;
- 37% between 35 and 59 years old;
- 28% 60 years old or more.

An equal number of males and females users were selected, since both genders are almost evenly represented (41% of visitors are males and 59% females). Moreover, amongst the selection criteria was the interest in museums, to ensure that the candidates were representative of the population that normally visits cultural heritage sites.

Finally, to encourage an effective response and collaboration, the selected candidates were given a monetary reward for their time and willingness in taking part in the study.

The usability tests were conducted at the University of Brighton and utilised a touch screen, to ensure consistency with the final setting of the application in the Chesterholm Museum. It was not possible to carry out the tests in Vindolanda because of the limited amount of time available and the location of the site.

It is also important to mention that each candidate was asked to sign a consent form before starting the test to allow the evaluators to collect personal data for statistical purposes and diffuse the outcomes of the research in scientific publications.

Once the selection criteria were defined, the evaluators developed an effective usability strategy to assess the Vindolanda Interactive Multimedia Application. The tests, designed to take one hour, were structured into three parts:

1. Preliminary questionnaire to collect the users' personal data;
2. Five tasks to test the application during which the evaluators observed the behaviour of the users and took notes;
3. Summary questionnaire to collect quantitative data and allow further comments.

The final questionnaires was partially modelled on the IsoMetric template (Heinz, 1998) and consisted of seventeen questions.

5.2.1 Results of the first round of tests: The first six tests highlighted a series of usability issues related to the interface and the navigability of the application. Although some of the users' comments related to the content displayed and the quality of the multimedia assets, this review will concentrate only on the outcomes regarding the interface, as they were the primary focus of these tests.

Some of the issues highlighted by the expert review, such as the length of the written information provided in specific pages, did not seem to pose any problem to the majority of the users. They mostly commented on the fact that could easily read the text due to the size of the font and layout and, more interestingly, because they were already familiar with explanatory panels in museums.

However, the functions and labels of the majority of the buttons caused confusion and in some cases did not allow a proper understanding and use of the application. Finally, most of the users found problematic to navigate within the 'Fort' and 'People' sections and to access the additional information that was in some cases provided. These outcomes lead the designer

to heavily modify the navigation functionality of the above mentioned sections (Figure 3).

Moreover, the labels of the majority of the buttons have been changed. They have also been moved within the screens, as it was observed that the proximity and visual relationship between elements substantially affected the way in which users interpreted their functionality (Figure 4).



Figure 3: Screenshot of the new 'Fort' Index Page in the third prototype



Figure 4: Screenshots of the same page: top, second prototype; bottom, third prototype

Although the original layout of the application has been kept unchanged, the third prototype of the application gained a richer look, thanks to the presence of more self-explanatory labels and the new navigation structure (Figure 5).

5.3 Second round of usability tests with six users: results

The methodological approach adopted in the second round of tests remained unchanged. Hence, only the results will be thereafter discussed.

One of the immediate effects of the improvement of the navigation structure and the introduction of new buttons' labels was the reduction of the average time needed to perform the

five tasks. During the first tests two users did not have time to perform the fifth task because of lack of time.

Conversely, amongst the second users, only one failed to complete all assignments, but mostly because of the long and detailed comments given whilst performing the test.

In general, the navigation was dramatically enhanced and simplified, as well as the users' understanding of the function of the buttons.

The modifications also improved the overall users' understanding of the type of information available: by adding the written labels to the video control buttons, for instance, all the users were able to immediately understand that they could play a movie-clip, while during the first session of tests some misinterpreted it for a still image (Figures 4 and 5).



Figure 5: Example of improved navigation structure: top, screenshot of the 'Fort' section in the second prototype; bottom, new 'Fort' subsection in the third prototype with buttons to access directly specific content in the top bar

Moreover, by moving the 'more' button closer to the text and, in some cases, renaming it 'the tablets', the users were more immediately able to understand that they could access additional written content and the topics they could deepen (Figures 4 and 5). Indeed, the two buttons opened windows displaying information about a relevant building in the fort or the Vindolanda writing tablets (Birley, 2005).

Nonetheless, some of the issues highlighted during the first round of tests persisted, such as the difficulty in appreciating the content of each section from the Home Page and the subsequent need of more explicit information.

Besides, new behaviours were observed: the new labels provided information more directly and the approach to specific tasks was therefore different.

The second series of tests gave also the opportunity to observe interesting unconscious behaviours. Two users were left-handed, yet they continuously used the right hand to click on the

screen. When asked about this behaviour at the end of the tests, they both admitted to have not noticed it and attributed it to causes not related with the application (such as the daily use of the mouse with the right hand).

Another interesting behaviour occurred in two tests: the users were constantly tapping on the arrow part of the buttons, avoiding clicking on the words or pictures. Once more, when asked to explain their actions, they both replied that the familiarity with internet navigation had unconsciously driven their behaviour. They also underlined that they would have recognised the hit area of the buttons if enclosed in a box.

These results highlighted that many museum visitors acquire their ICT skills from using a web browser to access the Internet or using a PC at home. This fact can be indicative of how technologies, such as touch screens, are becoming more accessible for average museum's users.

6. CONCLUSIONS AND FUTURE WORK

6.1 Conclusions

This paper has demonstrated the advantages of involving end-users in the early stage of development of a museum application: by testing the Vindolanda Interactive Multimedia Application iteratively throughout the design process it was possible to assess interface issues and, more importantly, improve its usability.

Furthermore, by assessing the improvement of the performances of the users, this paper has confirmed that the user-centered design and implementation approach adopted has the following advantages:

- It is cost-effective, as prototypes of the application can be tested and modified;
- It is time-effective, as a relatively small number of trials are necessary to detect major interface issues;
- It involves end-users from an early stage, allowing the collection of valuable feedback.

Hence, the approach could be recommended for future ICT applications for Cultural Heritage sites.

Finally, it is important to underline that in order to conduct an effective usability study is necessary to establish a continuous and active collaboration between designer, usability expert and museum manager.

6.2 Future Work

The designer of the Vindolanda Interactive Multimedia Application is currently planning to review the content to ensure that it integrates effectively within its final context of use – the museum.

It is important to underline that the users were spontaneously giving feedback on the content even though their usability evaluation tasks were mainly designed to assess the graphical interface.

Finally, to determine the validity of the conclusions of this research, it is hoped that it will be possible to deploy and evaluate the prototype directly in the Chesterholm Museum at Vindolanda, as this will also allow the observation of a larger number of users and evaluation of other elements such as the

most appropriate location within the museum space, the visitors' approach to the touch screen, etc.

7. REFERENCES

- Alzua-Zorbaral A., Linaza M.T., Abad M., Arretxea L., Susperregui A., 2005. Interface Evaluation for Cultural Heritage Applications: the case of FERRUM exhibition. *Proceeding of the 6th International Symposium on Virtual Reality, Archaeology and Intelligent Cultural Heritage (VAST 2005)*, Pisa, Italy, pp.121-128.
- Bird S., 2007. Deploying and assessing the impact of audio guides at the Roman Bath, Bath, UK. *Proceedings of the Third International Symposium on the Socio-Economic Impact of Cultural Heritage*, Brighton, UK, pp. 65-81.
- Birley A., 2004. *Vindolanda's Roman Eyeopeners. The ideal introduction to life on the northern frontier in Britain*. Greenhead, Roman Army Museum Publications.
- Birley R., 1994. *Vindolanda Research Reports Volume I - The Early Wooden Forts*. Greenhead, Roman Army Museum Publications.
- Birley R., 2005. *Vindolanda. Extraordinary records of daily life on the Northern Frontier*. Greenhead, Roman Army Museum Publications.
- Boehner K., Gay G., Larkin C., 2005. Drawing Evaluation into Design for Mobile Computing: A Case Study of the Renwick Gallery's Handheld Education Project. *Journal of Digital Libraries, Special Issue on Digital Museums*, 5(3), pp. 219-230.
- Carillo E., Rodriguez-Echavarria K., Arnold D., 2007. Displaying Intangible Heritage Using ICT. Roman Everyday Life on the Frontier: Vindolanda. *Proceeding of the 8th International Symposium on Virtual Reality, Archaeology and Intelligent Cultural Heritage (VAST 2007) Short and Project Papers volume*, Brighton, UK, pp. 51-55.
- Carillo E., Rodriguez-Echavarria K., Arnold D., 2008. Using visitor survey data to tailor heritage multimedia applications: Vindolanda case study. Presented at ATLAS Conference 2008, Brighton, UK.
- Danks M., Rodriguez-Echavarria K., 2007. The Interactive Storytelling Exhibition Project: a perspective on technology for interpretation. *Proceedings of the Third International Symposium on the Socio-Economic Impact of Cultural Heritage*, Brighton, UK, pp. 63-73.
- Danks M., Rodriguez-Echavarria K., Griffith R., Arnold D., 2007. Producing Interactive Digital Media Based Exhibitions to Engage Students with Cultural Heritage: Brighton Fishing Museum, A Case Study. *Proceedings of the International Cultural Heritage Informatics Meeting (ICHIM07)*, Toronto, Canada. <http://www.archimuse.com/ichim07/papers/danks/danks.html> (accessed 10 July 2008)
- Economou M., Pujol L., 2006. Educational tool or expensive toy? Evaluating VR evaluation and its relevance for virtual heritage. *Proceedings of the Conference on Cultural Heritage and New Media (Hong Kong, March 13-14, 2006)*, pp. 284-302.
- Economou M., Pujol L., 2007. Evaluating the impact of new technologies on cultural heritage visitors. *Proceedings of the Third International Symposium on the Socio-Economic Impact of Cultural Heritage*, Brighton, UK, pp. 109-121.
- Forte M., Pescarin S., Pujol L., 2006. VR applications, new devices and museums: visitors' feedback and learning. A preliminary report. *Proceeding of the 7th International Symposium on Virtual Reality, Archaeology and Intelligent Cultural Heritage (VAST 2006) Short Papers volume* (Nicosia, Cyprus, October 30 – November 04, 2006), pp. 64-69.
- Forte M., Pescarin S., Pietroni E., Rufa C., 2007. Multiuser Virtual Reality Museum Application for Cultural Heritage: the Ancient via Flaminia Project. *Proceeding of the 8th International Symposium on Virtual Reality, Archaeology and Intelligent Cultural Heritage (VAST 2007) Short and Project Papers volume* (Brighton, UK, November 26 – 30, 2007), pp. 90-97.
- Gay G., Spinazze A., Stefanone M., 2002. Handscape: Exploring potential use scenarios for mobile computing in museums. *Cultivate Interactive, issue 8, 15 November 2002*. <http://www.cultivate-int.org/issue8/handscape/> (accessed 28 August 2008)
- Heinz W., 1998. IsoMetrics[†]. Questionnaire for the evaluation of graphical user interface based on ISO 9241/10. Version: 2.01e. March 1998. <http://www.isometrics.uni-osnabrueck.de> (accessed 20 June 2008)
- McLoughlin J., Kaminski J., Sodagar B., 2007. Modelling the impact of technology on the heritage sector: Conceptualisation, implementation, and measurement. *Proceedings of the Third International Symposium on the Socio-Economic Impact of Cultural Heritage*, Brighton, UK, pp. 51-63.
- Nielsen J., 1993. Iterative User-Interface Design. *IEEE Computing*, Vol. 26, No. 11, pp. 32-41.
- Owen R., Buhalis D., Pletinckx D., 2005. Visitors' Evaluation of ICTs Used in Cultural Heritage. *Proceeding of the 6th International Symposium on Virtual Reality, Archaeology and Intelligent Cultural Heritage (VAST 2005)*, Pisa, Italy, pp. 129-136.
- Pujol L., Economou M., 2006. Evaluating the Social Context of ICT Applications in Museum Exhibitions. *Proceeding of the 7th International Symposium on Virtual Reality, Archaeology and Intelligent Cultural Heritage (VAST 2006)*, Nicosia, Cyprus, pp. 219-228.
- Rodriguez-Echavarria K., Morris D., Moore C., Arnold D., Glauert J., Jennings V., 2007. Developing Effective Interfaces for Cultural Heritage 3D Immersive Environments. *Proceeding of the 8th International Symposium on Virtual Reality, Archaeology and Intelligent Cultural Heritage (VAST 2007)*, Brighton, UK, pp. 93-99.
- Sadzak A., Rizvic S., Chalmers A., 2007. Influence of Storytelling Quality on the Human Perception of a Computer Animation. *Proceeding of the 8th International Symposium on Virtual Reality, Archaeology and Intelligent Cultural Heritage (VAST 2007) Short and Project Papers volume*, Brighton, UK, pp. 32-35.

8. ACKNOWLEDGEMENTS

The authors wish to acknowledge the Vindolanda Trust for the precious collaboration and unreserved availability in providing material. They also wish to thank the University of Brighton for allowing the use of the Usability Suite and providing the touch screen. Finally, they acknowledge the usability experts and the users that took part in this study.

The work presented in this paper is supported by a CHIRON (Cultural Heritage Informatics Research Oriented Network) fellowship. CHIRON is a Marie-Curie EU-funded network under contract number: MEST-CT-2004-514539.

Graphics Applications and Visualization Techniques

ON RENDERING 3D ARCHAEOLOGICAL VISUALISATIONS

A.J. Rigby*, M.Melaney* and K.Rigby*

*MellaniuM Ltd, Preston, Lancashire, UK PR3 3BN
(joe.rigby, mark.melaney,ken.rigby@mellanium.com)

KEY WORDS: 3D, interactive, Unreal 2, virtual reconstruction, Theatre of Pompey, CAD modeling, game engine

ABSTRACT:

Realistically rendered and textured virtual spaces can be created in the UNREAL platform by importing high polygon models and scaled accurately reproduced textures. In addition MellaniuM has successfully developed an application for utilizing all the archaeological virtual assets developed in 3D Studio Max over the past several years. It is possible therefore to create interactive environments of archaeological significance that can be accessed through the Internet and available to up to 40 participants. This paper will be accompanied by a live demonstration of networked PC's to illustrate the collaborative educational potential of this application.

1. INTRODUCTION

Archaeology would be well served by a software application that could faithfully reproduce buildings, artefacts and photorealistic art and import them into a multi-participant environment. Published literature extols the potential value of creating virtual spaces containing archaeological experiences for educational and/or archival purposes and even the publishing of the results of novel future excavations. Indeed, it would have to be admitted that reading, studying maps and schematic drawings about such monumentally extensive cities as Rome in 130 AD could not be compared to being able to walk around the city in a virtual reproduction. In fact the entire city of Rome was modelled in plaster in minute detail during the years 1937 to 1972 which by any stretch of the imagination was a monumental task but still falls short of giving the feeling of "being there"

Now it is time to seriously consider the modern day possibility of using the existing 3D virtual platforms available to generate interpretations of the major constructs of the ancient civilizations. There have been papers published comparing the relative merits of these platforms and their capability of rendering with sufficient fidelity the architectural detail and photorealism necessary to produce an acceptable environment. These publications have indicated that the UNREAL gaming engine does have some attributes which could potentially fulfill some of the requirements of a platform worthy to create 3D virtual spaces within which up to 32 individuals could simultaneously experience high resolution objects and photorealistic art reproduction.

In fact the UNREAL 2.5 variant has improved shading, light sourcing, high resolution pixel texturing and 2D graphics capability. Architectural applications have also been around for many years, finding in game editing a way to quickly visualize real estate developments and prospective designs with a low cost pre-construction interactive space. A number of projects have used the Unreal Engine for other architectural scenarios to: promote estate buildings^{1,2}; exhibit a protected natural park and help raise environmental awareness³ Researchers at the University of Auckland, New Zealand, use the Torque⁴ game engine to create a Collaborative Virtual Environment (CVE) to support architectural education. Through the CVE users can interact and share data in a common environment and concurrently explore shared architectural projects.



Figure 1: A view of the Coliseum imported into the UNREAL platform.

The AERIA project (2003) attempted to create archaeological reconstructions without the use of expensive CAD software. The authors⁵ used the Quake 2, HalfLife and Morrowind engines to reconstruct the palace of Nestor in Pylos and the throne of Apollo, respectively. They recognize that game engines have come 'of age' and offer a low cost but powerful tool for heritage visualisation.

Jeffrey Jacobson⁶ has created a set of modifications for the Unreal engine that allows visualisation in a customised CAVE environment incorporating multi-screen displays. These customisations make the creation of a low-cost CAVE possible thus enabling VR applications that would require an immersive setting to also use the extensive features of a game engine.

Maria Sifniotis⁷ has compiled an excellent summary of the game engines and their strengths and weaknesses.

The key to effective virtual realism, especially for fields like archaeology, is the creation of an environment so well conceived interpretively that the user becomes emotionally involved in the content of the simulation. Users obviously desire to experience a design that has been created in terms of lighting effects, finishes, surface textures, layout and construction details which will lend itself to a complete suspension of disbelief⁹

2. THE UTILIZATION OF THE UNREAL 2.5 PLATFORM IN THE ARCHAEOLOGICAL FIELD

The Unreal engine has been promoted in the past as a complete solution for the accurate rendering of architectural and archaeological reconstructions. However until the advent of the UNREAL engine version 2.5 and the wide acceptance of hardware 3D graphical acceleration video cards and DIRECTX 8.0 it was highly impractical to produce virtual buildings and accessory items with high polygon static meshes and photo-realistic textures and 2D graphics which were not subject to debilitating pixellation on close inspection.

The UNREAL engine provides "a complete robust solution that has withstood the tough test of time of real-world game development". The UnrealEd level editor is integrated with the rendering engine and along with the extensible C++ core, its powerful UnrealScript high-level scripting interface, visual editing of avatars and surface textures with the virtual world. In combination with Mellanium's adaptation⁸ of a "bridge between CAD and Unreal" using high polygon modelling in addition to the use of the application of scaled high resolution textures the stage is now set for inclusive, world building package that matches the more expensive and sophisticated CAD software. As mentioned already one of the Unreal engine's most potent features is the integration with the UnrealEd level editor. UnrealEd is a realtime design tool, optimized for building realtime 3D environments. It is fully integrated with Unreal's rendering engine, offering a WYSIWYG camera view and immediate display of all lighting, texture placement and geometry operations. UnrealEd also offers single-click playability: even in the midst of the design process, the designer can launch the viewer and walk around their created environment in real-time.

After the creation of the 3D models photo-realistic textures up to 2048x2048 pixels in size can be applied to surfaces to enhance the perceived detail of the object. This capability combined with detailed textured mapping allows for detailed effects of decorated walls and objects such as trees.

In effect since Unreal can handle up to 60,000 polygons in one modelled item and there is an indefinite limit to the size of the assembled unit even with a fully textured and lit surface the engine can therefore handle enormous spaces suitable for generating immersive archaeological scenarios.

3. MELLANIUM

One of the obvious Mellanium applications is not only as an advanced presentational tool for archaeology in education, but also as a archival tool for any new excavations. The Unreal engine in combination with Mellanium offers several novel possibilities for interactive, collaborative presentations and conferencing. The huge volume of 3D modelled assets which presently exist comprising the cities of Rome, Athens and the temple complexes of Egypt could be readily rendered and installed on a LAN or viewed collaboratively over the Internet. Indeed by using VENTRILO or TEAMSPEAK, economical VOIP's, it is additionally possible for up to 32 participants from all over the world to enter the virtual archaeological space and chat together as they wander together investigating the recreated surroundings.

4. THE DENOUEMENT

Existing models of extensive high polygon models developed in 3D STUDIO MAX can be readily modified and imported into the UNREAL platform using the Mellanium application to generate dimensionally scaled and high resolution textured environments. These environments are interactive and up to 32 participants can enter the virtual archaeological spaces using a LAN or an Internet connection. By the kind permission of KVL, King's Visualisation Lab, King's College London we were offered the opportunity to import the Theatre of Pompey into the UNREAL platform and we successfully completed this "proof of concept" project.



Figure 2: Screenshot of the KVL, King's Visualisation Lab, King's College London. "Theatre of Pompey" showing a view of the Temple of Venus Victrix.

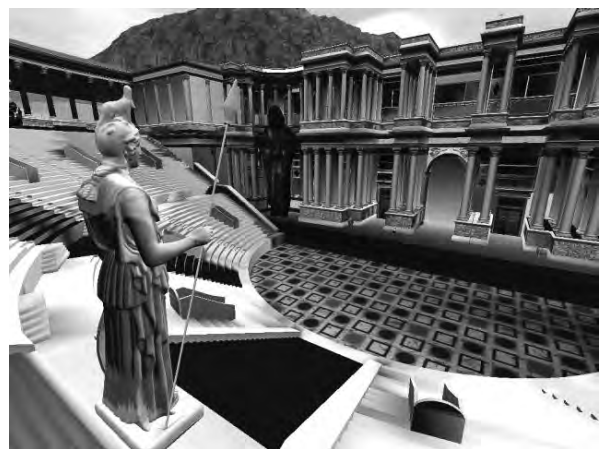

Figure 3: Screenshot of a view inside the KVL, King's Visualisation Lab, King's College London. "Theatre of Pompey" looking down on the stage.

The ability to create immersive, interactive virtual environments coupled with the technology to present and collaborate from anywhere on the Internet affords the Mellanium application significant potential as an educational and archival tool.

This paper will present the latest virtually reconstructed spaces including the Coliseum and the Theatre of Pompey showing avatars interacting realtime with the UNREAL environments.

5. REFERENCES

“Autodesk, MegaPrims, and the 3D Pipeline Puzzles Continue”
<http://dusanwriter.com/?p=481> “ Issues involved in Real-Time Rendering of Virtual Environments” Priya Malhotra *Thesis for the requirement of a Master of Science in Architecture July 19, 2002, College of Architecture and Urban Studies Blacksburg, Virginia*

Business Week: Unreal Architecture http://www.businessweek.com/innovate/content/dec2007/id20071221_129534.htm

DeLeon, V. and Berry, R. (1998), 'Virtual Florida Everglades', *Proceedings of VSMM Virtual Systems and Multimedia*

Jacobson, J. and Lewis, M. (2005), 'Game Engine Virtual Reality with CAVEUT', *Computer*, Vol. 38, pp. 79-82
3D Visa Bulletin, Sept 2007 Featured 3D Method: 3D Visualisation using Game Platforms Maria Sifniotis University of Sussex, UK, http://www.3dvisa.cch.kcl.ac.uk/paper_sifniotis1.html

Miliano, V. (1999), 'Unrealty: Application of a 3D Game Engine to Enhance the Design, Visualisation and Presentation of Commercial Real Estate', *Proceedings of VSMM'99 5th International Conference on Virtual Systems and Multimedia*, Dundee, Scotland, U.K, September

Moloney, J. and Amor, R. (2003), 'StringCVE: Advances in a Game Engine-based Collaborative Virtual Environment for Architectural Design', *Proceedings of CONVR 2003 Conference on Construction Applications of Virtual Reality*, Blacksburg, USA, September

Meister, M. and Boss, M. (2003), 'On Using State of the Art Computer Games Engines to Visualize Archaeological Structures in Interactive Teaching and Research', *Proceedings of CAA Computer Applications in Archaeology*

6. ACKNOWLEDGEMENTS

We deeply appreciate all the help and support we received from Prof. Richard Beacham and Martin Blazeby of the KVL, King's Visualisation Lab, King's College London.

RETOUCHING AND FRAME RECONSTRUCTION OF DEPTH IMAGE FOR AUTOSTEREOSCOPIC MONITORS

S. Ozawa^a, T. Abe^a, N. Naruto^a, M. Ogawara^a, M. Hirano^a, K. Tanaka^a

^a Research and Develop Department, Core Technology and Program Management Division,
NTT COMWARE CORPORATION,
1-6 Nakase Mihama-ku Chiba-shi, Chiba 261-0023 Japan – ozawa.shiro@nttcom.co.jp

KEY WORDS: Depth Image, 3D, Autostereoscopic Monitors, Stereo Measurement

ABSTRACT:

There have been many attempts to generate video for multiple view points using minimal data in order to use autostereoscopic displays which require input from multiple view points. Our research aims to establish technology to generate images with depth ("depth images") from two cameras or two images. In this paper, we propose requirements for high quality depth images for watching as videos. To meet these requirements, we also propose the retouching and frame reconstruction methods for the depth image that is generated by the stereo measurement.

1. INTRODUCTION

In recent years, interest in autostereoscopic vision has risen remarkably, not only because of entertainment and medical application opportunities, but also the advantages of highly realistic communication. Especially, the VR tour of heritage that uses the stereoscopic vision serves many uses. Much existing autostereoscopic technology requires special glasses for viewing. Unaided autostereoscopic viewing has attracted attention because it does not require the wearing of specialized glasses, allowing users to enjoy autostereoscopic visions more conveniently (Ezra et al, 1995; Takada et al, 2003).

Video composed of right-and-left view points has been used for existing autostereoscopic monitors requiring glasses or providing autostereoscopic vision for only a single viewer. Therefore, it has been easy to create 3D contents with CG images created by two cameras, or right-and-left view points.

On the other hand, there has been a recent increase in autostereoscopic monitor systems which allow many people to view autostereoscopic images at the same time. As a result, there has been an increase in the number of devices which require the input of five or nine view points.

Recording images of multiple view points is much more difficult than using two cameras, due to issues concerning recording devices, synchronization, and recording media. In order to resolve these issues, increasingly, attention is being focused on technology which generates quasi- images of multiple view points with two cameras recording actual scenes and depth images, replacing the distance between the filmed object and the camera with pixel data (Fehn, 2004).

However, there is a significant obstacle in obtaining depth images themselves, due to the necessity of using a particular kind of sensor called a range sensor, and due to processing, such as stereoscopic measurement, which is computationally expensive. In addition to these difficulties, certain problems tend to occur: generated depth images have low resolution, and noise results from computational errors (Gvili et al, 2003). Therefore, from the standpoint of autostereoscopic vision, we define depth images suited for image viewing, and propose a

retouching method of depth images from the existing stereo measurement techniques for autostereoscopic vision. Moreover, to solve the problem of our retouching method that is the flicker around the edge of objects in the stereoscopic images, we propose the frame reconstruction that limits the frame rates of the depth images, and evaluates the relationship between the quality of stereoscopic images and the frame rates of the depth image.

2. RETOUCHING OF DEPTH IMAGE

2.1 Effective Depth Images

There seems to be two weak points on which viewers focus when considering the quality of autostereoscopic vision while viewing depth images on an autostereoscopic vision monitor.

- The outlines of objects are vague and can not be seen clearly.
- "Bumpy" noise is seen on smooth planes.

The first reason for these points seems to be due to a lack of definition in object outlines, and the ease of depth measurement noise occurring around outlines. The second seems to be due to extreme depth in a small area on a smooth plane (infinite distance, or, conversely, almost no distance to the camera) because of errors in depth measurement.

Consequently, the following two factors can be defined as requirements for autostereoscopic depth images.

[Definition]

- (1) Clear outlines of objects for autostereoscopic vision
- (2) Low amounts of local noise in small areas

If depth image is generated as described above, effective autostereoscopic viewing of 3D video can be realized without the need for high precision depth measurement. The depth image retouching method is used for definitions (1) and (2).

2.2 Retouching Method

As described above, most of the existing stereo measurement technologies have aimed at improving precision of measurement, and faithful reproduction of object surface texture. Some factors cause degradation in image quality when depth images recorded offline are directly used for autostereoscopic vision.

The first is a loss in dot measurement data due to mistakes in stereo measurement. The second is slipping of measured data, which tends to occur around the outlines of objects. The third is generation of irregular data around the outlines of objects. The first corresponds with factor (2) and the second and third correspond with factor (1) described in Section 2.1.

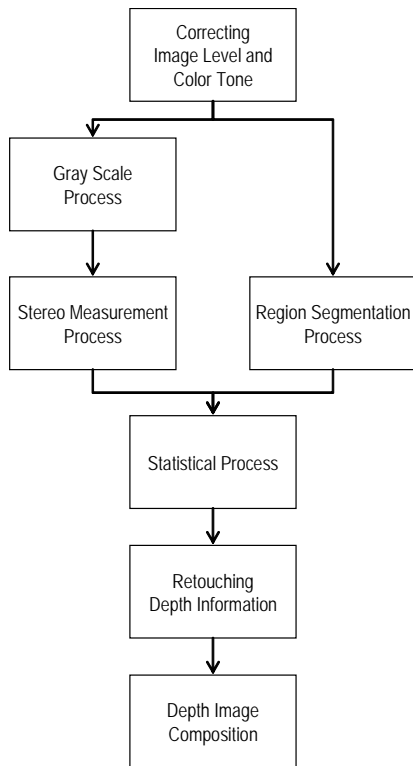

Figure 1: Processing flow diagram of retouching method

In this paper, in order to solve these issues, our method is to correct the results of stereo measurement based on visible “outlines” or “noise” in autostereoscopic vision during the region segmentation process, and then to generate depth images.

Figure 1 shows the processing flow diagram for this method. First of all, as pre-processing for stereo measurement, image level and colour correction is performed for right-and-left parallax images in order to make images suitable for shading or colour processing. Gray-scale video is assumed as the input for stereo measurement processing.

The well-known Dynamic Programming Algorithm is used for the stereo measurement process (Birchfield and Tomasi, 1998). The Efficient Belief Propagation for Early Vision Algorithm is used for region segmentation processing, in synchronization with stereo measurement processing (Pedro and Daniel, 2006).

This region segmentation process is used to make the outlines of objects in autostereoscopic vision clear.

In statistical processing, the results of stereo measurement are aggregated based on region information provided by region segmentation processing. The optimal depth value is decided based on the aggregate results of statistical processing.

In correcting depth information, the decided depth value is applied uniquely to the region. Applying the results of statistical processing enables generation of video with less small-region noise of extremely near or far regions.

The above-mentioned processes provide depth images that improve the visual quality of autostereoscopic video via reference to highly accurate stereo measurement depth values.

2.3 Evaluation and Problems

In order to evaluate the retouching method, we performed experimentation with video recorded with a stereo camera.

Figure 2 shows the original image used for measurement. Figure 3 shows the results of stereo measurement using the Dynamic Programming algorithm without region segmentation processing. Figure 4 shows the corrected results of stereo measurement using our method.

Comparing figures 3 with 4 proves that this method is effective in minimizing the effect of slipping of measurement data (horizontal needle-shaped noise) occurring around the outlines of objects. It also shows that there is a reduction of bleed-over outside of the outlines of objects. These results show that correcting the results of stereo measurement with region segmentation or statistical processing greatly improves the quality of autostereoscopic video.



Figure 2: Original Image



Figure 3: Result of stereo measurement



Figure 4: Result of our method

However, there is an issue to see our result.

In our method, the relations between frames are not considered because of individual processing is done in each frame. Therefore, the depth values are changed and the position of the edges are moved because of the statistical processing and the region segmentation processing, even if the depth value is not expected to change so much in the same area.

Figure 5 shows the example of these phenomena. The bottom image is 1 frame later than the top image in the time line. In the figure 5, the bottom image is one frame later than the top image on the time line. However, it can be seen that there is change in depth data between these frames in the red broken line. Moreover, the results of the region segmentation processing are different between the two frames in the bottom area.

If this depth image is seen as stereoscopic images, it can be seen “flickers” around the edge of the area where such phenomenon are generated, because of the rapid changing in depth data and moving the position of the edges. As a result, it causes the quality decrease as stereoscopic image.

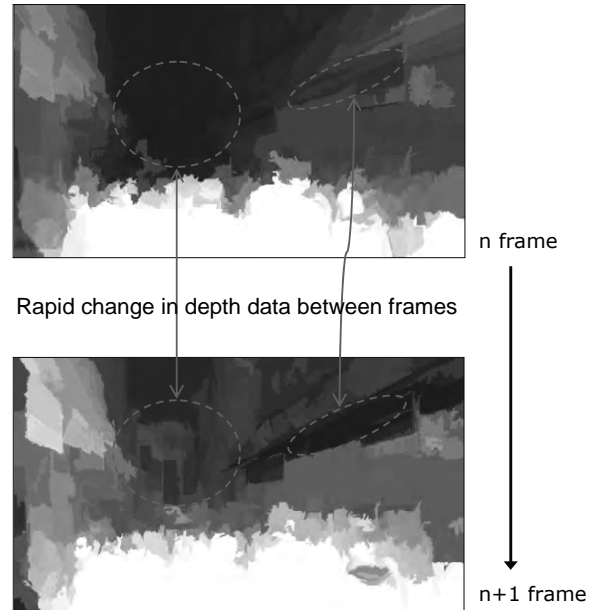

Figure 5: Issue of our retouching method

3. FRAME RECONSTRUCTION

3.1 Frame Rate of Depth Image

The flicker described in the preceding chapter is generated because a depth value and an outline position change rapidly between consecutive frames. To solve these issues, it can be thought that the statistical processing with following up the change of depth value in time line corrects them, but the amount of the change of the depth is counterbalanced in the statistical procedure because there is a case of the different pattern of the change of depth value in different area. In the case of figure 5, the depth value of the left red broken line area became brighter, but the depth value of the right red broken line area became darker after n frame in figure 5.

On the other hand, when focusing to the cause is the rapid change in short term at the same area, it can be thought that the less frame rates of depth image will bring the alleviation of the change of depth data and reduce the flicker. Therefore, we have verified whether the less frame rates of the depth image brought suppression of the flicker.

3.2 Subjective Assessment

In the case of the flicker is reduced by the less frame rates of the depth image, the other inferior quality stereoscopic image will be brought by the displacement between depth information and image information. Especially, the displacements will ingenerate the unpleasant sensation around edges of moving objects.

To evaluate the alteration of the quality of autostereoscopic image with the less frame rates of the depth image, we set “the flicker of the image” and “the displacement between depth information and image information” to the evaluation item, and we conducted the subject assessment while changing the frame rates of depth image.

The procedure of the subjective assessment is as follows.

1. The examinees are indicated the observable area to arrange the watching area of examinees in the image.
2. The examinees watch original image as basic evaluation data, and remind the score of this images are 5 points in 10 points full marks.
3. The examinees mark “the flicker of the image” and “the displacement between depth information and the image information” of the stereoscopic images of 5 fps, 10 fps, 15 fps, 20 fps, 25 fps and 30 fps in six patterns of different frame rates of depth image in 10 points full mark. However, the examinee is not given information on the frame rate, and evaluates it from pattern A, B, C, D, E and F.
4. The examinees select the stereoscopic image of the best quality they feel from among 6 patterns without any relation to the two evaluation items.
5. These procedures are executed in three scenes.

Images used for the evaluation are three scenes in figure 6, 7 and 8. Scene I is an image of the walking two rhinos that took a movie from the fixed video camera. Scene II is took a movie from the video camera that goes through on the road where the stall lined up. Scene III is took a movie from the camera that pans from the left to the right in a garden.

The autostereoscopic monitor used for the evaluation is 9 view points, lenticular type and 42 inches (Philips, 2005). This monitor accepts the input of depth images directly.



Figure 6: Scene I



Figure 7: Scene II



Figure 8: Scene III

4. RESULT

4.1 Result of Evaluation

The subjective assessment has been conducted to the 25 examinees, and figure 9, 10 and 11 shows the result of the evaluation.

X-axis of the graphs means frame rates of the depth images in every 5 fps from 5 to 30 measurement results, respectively.

The graph plotted the blue diamond is flicker scores, and the green triangle is displacement score, both the Y axis correspond to the numbers on the right side. Orange bar chart indicates the number of selected frame rates of the depth image as the best quality by the examinees. The number of selection on the Y axis corresponds to the number on the left side.

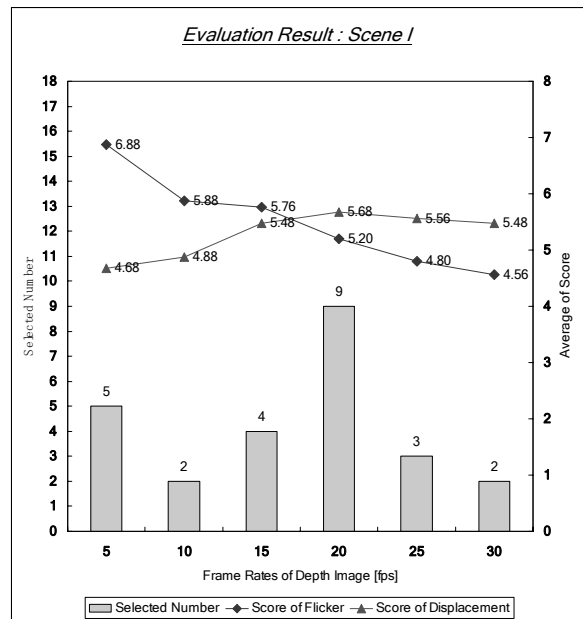

Figure 9: Evaluation Result of Scene I

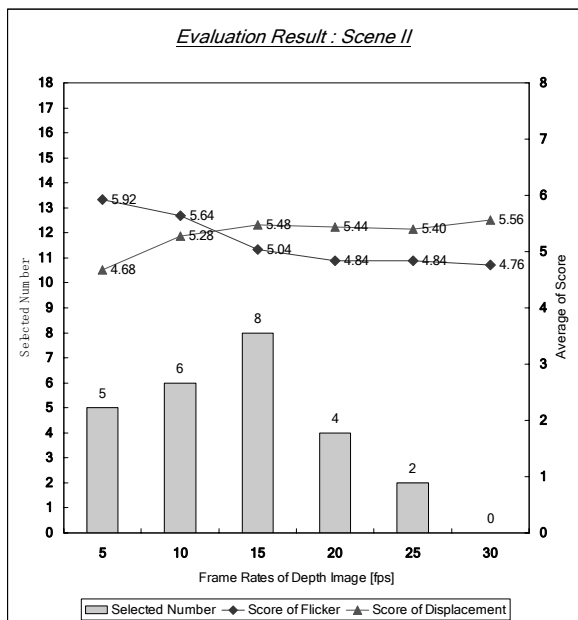

Figure 10: Evaluation Result of Scene II

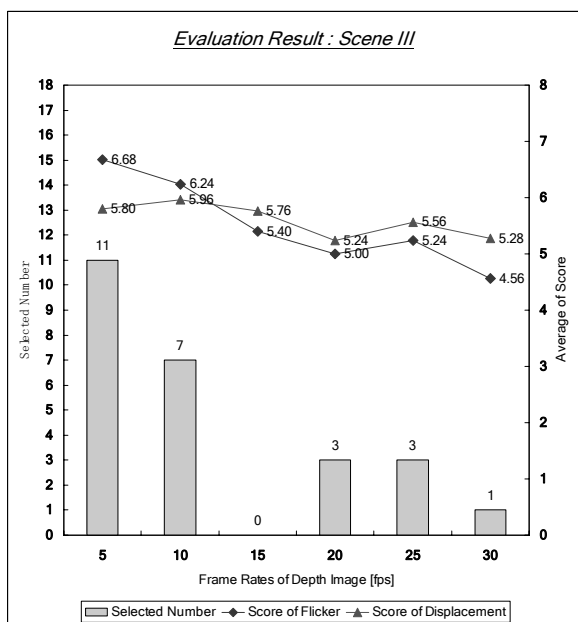

Figure 11: Evaluation Result of Scene III

4.2 Observations

According to figure 9 to 11, the flicker decreases while the frame rates of the depth images decrease. We had expected it is because the less frame rate of depth image can reduce the flicker of stereoscopic images.

Meanwhile, the displacement between the depth information and image information of Scene I and Scene II increases slightly while the frame rates of the depth images decrease. However Scene III is not very noticeable difference as a result of the evaluation. The reason of this is also related the best selection of stereoscopic images, it attributes the movement

speed of focused objects on the image plane. Compared to the Scenes I, II and III, the movement speed of focused objects on the image plane is the fastest in Scene I, followed by Scene II and the focused object in Scene III move more slowly. In conjunction with this movement speed of the focused object on the image plane, the number of the frame rates selected as the best quality is 20 fps in Scene I, 15 fps has been selected in Scene II, and 5 fps has been selected in Scene III. Therefore, in the viewpoint of quality of stereoscopic images, it can be expected that there is a connection between the frame rates of the depth images and the speed of objects on the image plane.

To regard the relevance of the scores of the flicker and the displacement, it doesn't lead to a good evaluation where only either score is high, but it leads to a good evaluation when these two score bring a balance. To compare the position in which the score of flicker intersects with the score of the displacement and the frame rates selected as best quality, it can be expected that there is a relation between the quality of stereoscopic image and the balance of the flicker and the displacement.

Through the evaluation, it can be mentioned that the image quality and selected scene greatly influence the evaluation that uses the live-action images. Therefore, there is necessity for making the simulation data with CG if the evaluation items are strictly evaluated.

5. CONCLUSION

In this paper, we have defined requirements for depth images for autostereoscopic vision, and proposed retouching method for depth image that generated by existing stereo measurement techniques to generation of depth images which satisfy the defined requirements. Moreover, we have proposed the frame reconstruction method that limits the frame rates of the depth images to reduce the flicker of the stereoscopic images.

Our proposal is an approach to retouch the results of stereo measurement with region segmentation and statistical processing, resulting in improvements in autostereoscopic quality compared with existing stereo measurements. We also discovered that the issue of relationships between individual frames needs to be considered, as well as issues involving parameter settings for region segmentation.

We also clarified the flicker around the edges of objects that attributes the rapid changing in depth data and moving the position of the edges can reduce with the control of the frame rates of the depth images with the subjective assessment. And this result of the evaluation confirm that the frame reconstruction method that control the frame rates of the depth image in conjunction with the movement speed of objects on the image planes.

We would like to formulate the relationship between the movement speed of the object and the frame rates of the depth image, and we would also like to realize the frame rate control technique. Moreover, we will consider methods for generating video with multiple viewpoints from depth images.

6. REFERENCES

References from Journals:

Ezra, D., Woodgate, G., Omar, B., Holliman, N., Harrold, J. and Shapiro, L., 1995. New Autostereoscopic Display System. *Sharp Technical Journal*, vol. 62, pp.10–14.

Pedro, F. and Daniel, P. Huttenlocher., 2006. Efficient Belief Propagation for Early Vision. *International Journal of Computer Vision*, Vol. 70, No. 1.

References from Other Literature:

Birchfield, S. and Tomasi, C., 1998. A Pixel Dissimilarity Measure that is Insensitive To Image Sampling. *IEEE Transactions on Pattern Analysis and Machine Intelligence*, 20(4), pp.401-406.

Fehn, C., 2004. Depth-image-based rendering (DIBR), compression and transmission for a new approach on 3D-TV. *Proceedings of the SPIE Stereoscopic Displays and Virtual Reality Systems*, XI, pp. 93-104.

Gvili, R., Kaplan, A., Ofek, E. and Yahav, G., 2003. Depth keying. *SPIE Electronic Imaging Conference*, Santa Clara, California.

Takada, H., Suyama, S., Hiruma, K. and Nakazawa, K., 2003. A Compact Depth-Fused 3-D LCD. *SID03 Digest of Technical Papers*, vol. 28-2, pp.1526–1529.

References from websites:

Koninklijke Philips Electronics N.V., 2005. 3D Displays. <http://www.business-sites.philips.com/3dsolutions/products/3dscreens/> (accessed 13 Aug. 2008)

TANGIBLE 3D INTERFACE FOR SOUND MANIPULATION

Masami Hirabayashi^a, Takahiro Kobayashi^b, Toshio Shimizu^b, Norihisa Nagano^b

^a International Academy of Media Arts and Sciences (IAMAS), 3-95 Ryokecho, Ogaki, Japan - hrr@iamas.ac.jp

^b Institute of Advanced Media Arts and Sciences(IAMAS), 3-95, Ryokecho, Ogaki, Japan –
(kobayasi, nagano07, shimizu07)@iamas.ac.jp

KEY WORDS: VR, Tangible interface, Real world orient, sound edit, 3D view

ABSTRACT:

The tangible manipulation technique corresponding with three dimensional display techniques is an important factor for the real world oriented interface. In this paper, we propose the real world oriented tangible interface with stereoscopic objective display that enables haptic sensation for sound manipulation. We use the plastic cushion as tangible interface material, and employ duality rendering that enables 3D projection to freeform screen for stereoscopic image projection on the cushion. The characteristic of the material of cushion enabled moderated feeling in pressure, three dimensional manipulation, and capture of manipulated data. In the projection of 3D images, duality rendering method enabled distortion-free 3D display at the cushion without wearing any glasses, just using a headphone attached position sensor for sound monitoring. We verified the tangible interface with the 3D objective display utilizing the plastic cushion, and its possibility. We also verified possibility of the 3D tangible interface for sound manipulation. We try to give substance to sound, which originally does not have a solid 3D form and cannot be touched directly by hands.

1. INTRODUCTION

In the area of the real world interface, tangible interfaces are spreading and becoming popular. A tangible interface uses an target that can be touched and used as an interface to create a more lifelike sensation. In this paper we propose a tangible interface that unifies the stereoscopic view and the haptic sensation. We use the malleable plastic cushion for input interface to enable haptic sensation. For stereoscopic view, we use an objective display that projects 3D images to the cushion, enabled with monocular moving parallax. With this interface, we realize and evaluate a new way of tangible sound manipulation that has the stereoscopic objective display and the haptic operation.

Tangible interfaces like info.Table (Suzuki 2001), Illuminating Clay (Piper, 2002), Digital Clay (Ishii, 2004), and PlayAnywhere (Wilson, 2005) enable intuitive interface, and they use the interface itself as a screen, but it is difficult to display with 3D view. Stereoscopic view using glasses tends to obstruct actual view, so application to the real world oriented environment is hard to accomplish. We employ duality rendering technique (Kondo, 2002; Kondo, 2006) to display stereoscopic view, and use the malleable plastic cushion as an interface device to enable tangible interface with stereoscopic view. Digital Foam (Smith, 2008) is a interesting haptic interface that uses plastic material, but it has difficulty to display images on itself.

In this study, we created an editing system that targets sound on a stereoscopic display. Tangible interfaces that target sound or music are presented in the concept of Tangible Bit (Ishii, 1997) and many studies (Patten, 2006) and equipment are there like reacTable (Jordà, 2006), and so on. Most of these studies use sound as reaction, or musical expression. We believe that tangible sound edit interfaces are still a new viewpoint. In our method sound can have stereoscopic view by giving substance to sound, and haptic sensation by using a plastic cushion. We

try to realize intuitive operation with unification of the 3D view of sound and haptic sensation.

Our objective is summarized as follows:

- apply stereoscopic view on tangible interface
- evaluate capability of 3 dimensional manipulation of sound.

We implement the application called “Tangible 3D Graphic Equalizer” (Nagano, 2008) to verify our approach.

2. EDIT OF SOUND

The most popular way to edit sound data is based on a wave form that shows timeline and amplitude of the sound. Software for music editing, Logic Studio (Apple), Cubase (Steinberg) and Protools (DegiDesign) etc, offer wave form based editing. Metasynth (High Resolution) exceptionally offers sound editing based on power spectrum of sound, but is very rare in music software. The most common way to edit sound is to cut/copy/paste pieces of sounds and apply effects, such as low-pass or high-pass filter, to a piece of sound data. Directly editing wave form of sound with tools like pens/erasers is not common way. In editing of the wave form, it is difficult to intuitive manipulation of sound depends on frequency of sound.

With a power spectrum display, sound frequency and intensity can be confirmed on a time axis as in Figure 1. In this expression, we can clearly view frequency and its loudness that also can enable intuitive editing of sound. Although two dimensional expression is enough in wave form view, spectrum view needs three dimensional expression, time, frequency and volume. In two dimensional view, sound volume is normally presented in color. But we cannot accurately understand difference of color as difference of volume, even if correspondence of color and value is specified. We can express volume as height of the spectrum by employing stereoscopic view of the power spectrum, this brings intuitive operation

whereby changing the height of the spectrum changes the volume of sound.

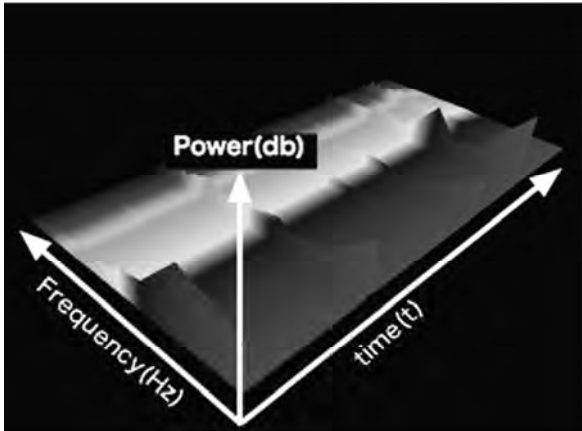

Figure 1: Power Spectrum of Sound

3. DUALITY RENDERING

We adopt duality rendering as the display method for stereoscopic projection of power spectrum of sound. The duality rendering can project the stereoscopic images by utilizing monocular moving parallax to a free-form screen including various solid materials. We achieve integration of the input interface and display screen into a single material by projecting 3D images to the plastic cushion with this method.

In the process of duality rendering, the pre-distorted image is produced from the form of the solid screen that has been measured, and posture/position of the person get from the sensor. The image projected to the solid screen becomes anti-distorted image that offsets distortion. The image can also be viewed stereoscopically when the user sees the image with one eye by moving his/her eye.

If the form of the screen can be captured in real time, we can get a distortion-free image when the screen, which also doubles as the interface, is deformed. The motion of the eye is captured as motion of the head with posture/position sensor, the image is created with duality rendering and projected to the screen, then the person can see the stereoscopic view continuously by moving the parallax of the one eye. Therefore the person watching the stereoscopic view of the power spectrum by moving his/her eye (head), as if viewing from a screen.

This technique can achieve direct projection of the 3D images to the 3D form screen without any glasses.

However, there is a problem where the stereoscopic view is not viewable without movement of the eye. This means that when the head is held still, the image can only show the 2D view of the spectrum.

The problem may be solved with intentional movement of head, or gaining experience to grow accustomed to the operation.

4. CUSHION INTERFACE

We employ the malleable plastic cushion both for the haptic interface and the 3D form screen to which the stereoscopic view

is projected. With the cushion, we achieve an intuitive interface that unifies stereoscopic view with haptic sensation when the cushion is pressed. This haptic sensation is one of the characteristics of our proposal, which cannot and cannot be created with solid materials.

The deformation of the cushion when pressed is captured by a 3D image sensor. By comparing initial form with pressed form of the cushion, we can know where and how much the cushion is pressed. The frequency, time and how much to decrease volume is determined by the position and amount of pressure by comparing the result from sensor with corresponding area of the power spectrum. For instance, the projected images to the cushion as Figure 2, becomes stereoscopic when the viewer's eye moves.

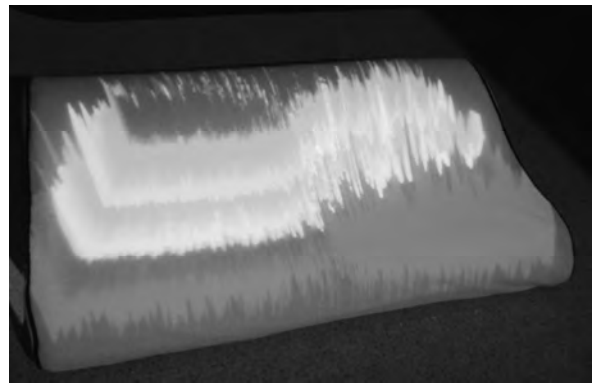

Figure 2: Projected Image on Cushion

In this interface, when the cushion is pressed by a finger or hand, thickness of the finger/hand causes error in sensing deformation. Because of this error, a malleable cushion, that maintains its depression for a time helps measurement of the deformation. There is also another merit of this malleability where the amount of pressure can visually be confirmed by oneself. Of course, this depends on the accuracy and response time of the sensor. Under these conditions and restrictions, we evaluate several candidate cushions and select one that has enough thickness, plasticity, and weak stability. We compare three cushions shown in Figure 3. The left one is stiffer than the others. The depression when pressed is quickly, almost immediately, restored to the initial form. The center one is softer than the left one. The depression is restored more slowly when pressed. The right one is thinner than the others, and as soft as the center one. After some trials, we chose the center one. It is malleable enough to keep the depression and has enough depth to transform. It takes about 3 seconds when pressed 1cm, about 4 seconds when pressed 2cm, about 5 seconds when pressed 3cm respectively. The size of the cushion is 7 to 9.5cm in height, 30cm in depth, and 48.5cm in width.



Figure 3: Three Candidate Cushions

As the result, the characteristic of the cushion interface has merits;

- haptic interface by which pressure can be felt
- visually confirm the shape of the depression and has demerits;
- not suitable for quick operation
- the form of the stereoscopic view projected on the cushion and the form of the cushion do not match.

5. SYSTEM

This system are consists of :

- PC1: process the operation to the cushion (Pentium M 1.8Ghz 1G memory)
- PC2: rendering images from position sensor and playback sound (Mac Book Pro)
- magnetic posture and position sensor (Polhemus Fastrack)
- 3D image sensor measure form of the cushion (Canesta DP-203)
- one projector, one cushion, one set of headphones, and one wooden chair.

Figure 4 shows outline of the system, and Figure 5 shows appearance of our system.

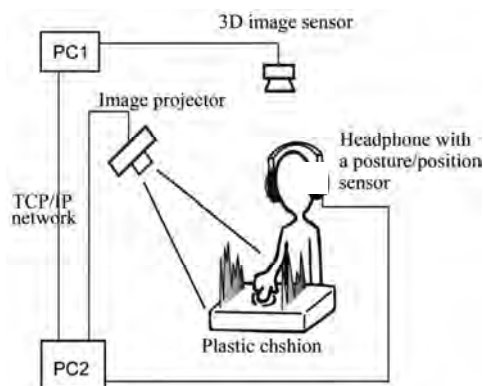

Figure 4: Outline of System



Figure 5: Appearance of the System

DP-203, the 3D image sensor used to measure distance, has a 64x64 matrix resolution with 1cm accuracy from 100cm off the target.

This sensor is placed 100cm up from the cushion and adjusted to respond to the whole area of the cushion.

Measured data is sent from the sensor to PC1 at a rate of 20fps, and after noise reduction through a low-pass filter, PC1 detects the distance from the cushion. For each pixel, if the depression from initial form exceeds 2cm (the threshold value), we decide that the cushion has been pressed, so the operation is performed. The threshold value 2cm is determined from accuracy of the sensor (about 1cm), under consideration of error.

After this process, the center of the depression is calculated and the volume is estimated within 5 grades. It takes 1 or 2 seconds to determine the value of the sensor after the cushion is pressed. Therefore this system is not suitable for quick operation at present. The acquired data, center position, degree of volume and radius, are sent to PC2 via TCP/IP network connection.

PC2 covers generation of the spectrum view with duality rendering and manipulation of sound data such as edit and playback. The power spectrum is calculated from sound data via FFT process, and the projected image is generated by duality rendering according to the position of the eye as acquired from the posture/position sensor. Those images are projected to the cushion screen with an LCD projector. From the data received from PC1, the corresponding position of the spectrum view is determined to process the sound data, and reflect the changes to the spectrum view.

In duality rendering technique, position of user's eye is necessary. We affix the position sensor to the headphones, with smaller influence to the sensor to avoid disturbance of smooth operation.

6. TANGIBLE 3D GRAPHIC EQUALIZER

We make the application called "Tangible 3D Graphic Equalizer" (T3DGEQ) using this system. T3DGEQ (shown in Figure 6) is the application to verify our tangible interface with the cushion and efficacy of the stereoscopic view with duality rendering. We also intend to verify a new way of three dimensional operation interface for sound, which originally is not a three dimensional form.



Figure 6: Experience with T3DGEQ

It is natural to edit material that originally has a 3D form in 3D operation environment, but small differences or inconveniences are easily recognized. As we mentioned earlier, wave form based editing is common in a sound edit environment, so we rarely experience sound editing in 3D. We have tried to give substance to sound. This fact, we consider, has the capability to bring new experiences and new ways of sound editing that do not exist in traditional methods. We also believe that the idea for 3D editing interface for materials with non-3D form can applied to other targets, not only sound.

For our first prototype, we implemented a graphic equalizer that enables 3D operation as interface by displaying a 3D view of the sound spectrum. This application focused on the operation of sound editing. Monophonic 4-second long sound data playback is looped. While monitoring this sound, the user can edit the sound data in stereoscopic spectrum view.

Users of this application can edit the sound by pressing the cushion, onto which a spectrum view of sound is projected, and where the spectrum view is pressed on the cushion, the sound volume decreases. The projected image on the cushion can be seen stereoscopically with moving parallax, so the user can intuitively and visually grasp frequency and its volume like series of connected mountains. The harder the cushion is pressed, the greater the volume decreases. By correlating sound with the depressions in the cushion, a sense of unity between touch and image is created.

For the current application, we only implemented decrease of volume just to verify our interface system. We think further functions will be necessary such as increase of volume by introducing "mode," or functions for sound transfer (play, stop, ff, rew), or zoom in/out of view. In these functions we believe that gestures over the cushion may be used to operate and display menus in midair by using features of the duality rendering technique.

7. EVALATION EXPERIMENT

We conducted questionnaires described below to evaluate this system.

7.1 Questionnaires

Questionnaires were given to 8 persons (4 1st time users, 3 onetime users, 1 frequent user) as samples. We previously explained the abstract of this system; this is a kind of graphic equalizer, you can get stereoscopic view by moving your head with one eye.

Their ages were from 22 to 50 years old, 5 male and 3 female, 3 of which have used sound editing tools. The score of each question is graded in 5 points (no to yes), so 3 is medium value. The answer "do not know" is scored as 0, and ignored when calculating statistics. The questions are as follows:

1. Did you see the stereoscopic view of the sound?
2. Did you feel changes in sound?
3. Did you understand what each axis of 3D view indicates?
Connect each of left and right.

left-right	musical interval
front-rear	time progress
up-down	volume

4. Did you feel interference in operating in the cushion interface?
5. How tall was the peak in stereoscopic view?
6. Was the cushion interface ergonomically pleasing?
7. Did you sense correspondence between variation of sound and operation of interface?
8. Did you feel like you were touching the substance of sound?
9. Did you understand the operation of interface from the shape of the displayed image?
10. Did you feel incongruity in the operation where volume is decreased by pressing?
11. Were the headphones uncomfortable?
12. Did you enjoy this experience?
13. Did you feel the interface had merit compared with ordinary graphic equalizers?
14. What kind of operations did you want to do with this system? What operations do you think are reasonable for this system?
15. What do you think after experiencing this system?

They experienced T3DGEQ for several seconds, and then they answered questionnaire.

7.2 Result

Result of questionnaire is shown in Table 1, and the result is shown in Table 2.

Q\S	1	2	3	4	5	6	7	8
1	4	4	4	4	3.5	4	5	4
2	4	5	4	0	5	4	4	5
3	0	3	0	0	3	3	3	3
4	3	2	3	1	3	3	5	1
5	15	30	5	20	10	30	20	40
6	3	3	3	4	4	3.3	4	4
7	4	4	4	3	5	3.7	4	4
8	1	1	1	3	0	3.3	4	2
9	2	4	0	4	4	3.2	1	5
10	3	2	1	0	2	1.2	4	1
11	1	1	1	1	1	1	3	1
12	5	4	2	5	4	4	4	4
13	1	3	3	3	2	3	4	3

Q:questionnaire, S:subject

Table 1: Answers of questionnaires

The summary of the results are as follows:

- The stereoscopic view is visible but difficult to make out
- It is easy to recognize the changes of sound
- It is difficult for first-time users, who cannot grasp what spectrum represents
- The cushion leaves a good impression in both sense of touch and operation
- Most users cannot specify the peak height of the view
- Users cannot feel the substance of the sound
- Users do not feel strange wearing the headphones (including sensor)
- As a graphic equalizer, we cannot determine if it is useful or not

Q/R	AVRG	SD	SE
1	4.06	0.42	0.15
2	4.43	0.53	0.20
3	1.88	1.55	0.55
4	2.63	1.30	0.46
5	21.25	11.57	4.09
6	3.54	0.50	0.18
7	3.96	0.54	0.19
8	2.19	1.25	0.47
9	3.31	1.38	0.52
10	2.03	1.13	0.43
11	1.25	0.71	0.25
12	4.00	0.93	0.33
13	2.75	0.89	0.31

R: result, AVRG: average, SD: standard deviation, SE: standard error,

Table 2: Result of the questionnaires

First we inspect about the cushion as interface and also the screen to which duality rendered image projected. From Q4, we can consider that the specification (color, size, position) and function (screen for duality rendering) of the cushion does not obstruct operation. From Q6 and Q7, they answered in favor of interface itself and its operation feeling. We therefore believe that this system can take advantage of interface at least. In experience for large scale system like this, users generally tend to shy away. This system require only to be wear the headphones in preparation for experience, and the objective is to edit sound, so they are not hesitant as in Q11.

In Q3 we ask the peak height in stereoscopic view of the spectrum, to investigate how they watch the stereoscopic view. As the result, the answers are scattered from 5cm to 40cm.

This means possibility of malfunction of stereoscopic view with moving parallax. Some reasons are considered for this result such as problem on the system, less precision to revise duality rendering, latency of display, and so on. However S8, who is accustomed to this system, gave most accurate answer, other problem in moving parallax may cause this result. We use sound data that has the tall peak in front area of stereoscopic view whose peak obstructs the back view. It can consider that this tall peak was not recognized as peak but something obstacle. They cannot recognize this tall peak, but recognize other smaller peak as the tallest one. This is a still problem, but we will try to find out the reason with further questionnaires and improvement of the system.

They did not feel much incongruity with the action of pressing the cushion to decrease volume of sound for the sound manipulation, shown in Q10. Therefore we appreciate this is natural operation for sound. The impression for the cushion is also not incongruous from Q6.

Although one of our trials to give the visual substance to sound was achieved in the point of stereoscopic view shown in Q1, they did not recognize the solid substance of sound as Q8. We think that graphic image deterioration causes this result. It remains as a problem needs further development.

From Q12, they think that experience itself is interesting. Three subjects has work with traditional sound edit software, two of them answer that it is interesting. However, compared with traditional graphic equalizers, they think that there is no clear merit in T3DGEQ. This means we must continue to present further application that fully utilizes the merit of the system.

As useful comments in Q14, we have the idea that changing perspective or displaying a cubic guide box to make the view better, for example. We will continue to improve the system referring to these comments.

8. CONCLUSION & FUTURE WORK

We proposed new tangible interface that has stereoscopic view and haptic sensation, and evaluate by experimentation. Haptic operation using the malleable plastic cushion as an interface, stereoscopic view with moving parallax projected to the cushion as screen, we try to enable intuitive operation with these two factors. We implement the sound edit application to verify our proposal. This also includes an idea for new manipulation method for sound, by which gives substance to sound with stereoscopic view.

We confirmed basic validity of our proposal, the interface that enables intuitive operation. However we could not archive precise manipulation, we confirmed problems such as in accuracy and latency of sensor.

For future work, we need to implement further function to edit sound, such as transfer (play, stop, pause etc.) or amplitude of sound, control with menu structure, zoom in/out, and so on.

Another approach for sound editing using stereoscopic view of sound, such as composition of two 3D forms of sounds, transformation of 3D form of sound like sculpture, can be considered as a new way to edit sound. This can also be used to create sound. For instance carving a human's voice from a white noise brick like sculpturing using formant eliminate forms (where the formant is a set of specific primary frequencies included in human's voice).

9. REFERENCES

References from Journals:

Ishii, H., Ratti, C., Piper, B., Wang, Y., Biderman, A. and Ben-Joseph, E. 2004. Bringing clay and sand into digital design -- continuous tangible user interfaces, *BT Technology Journal*, Vol. 22, No4.

References from Other Literature:

Ishii, H., Ullmer, B. 1997. *Tangible Bits: Towards Seamless Interfaces between People, Bits and Atoms*. Proceedings of CHI '97 (March 1997), ACM Press, 234-241.

Jordà, S., Geiger, G., Alonso, M., Kaltenbrunner, M. 2007. The reacTable: exploring the synergy between live music performance and tabletop tangible interfaces. Proceedings of the 1st international conference on Tangible and embedded interaction. pp.139-146.

Kondo, D., Kijima, R. 2002. Proposal of a Free Form Projection Display Using the Principle of Duality Rendering, Proceedings of VSM 2002, pp.346-352.

Kondo, D., Kijima, R., 2006. "A Study on Perception and Operation Using Free Form Projection Display", *Interactive Technologies and Sociotechnical Systems, Lecture Notes in Computer Science*, vol. 4270/2006 (VSMM2006), pp. 103-109.

Nagano, N., Shimizu, T., Kobayashi, T., Hirabayashi, M. 2008. *IPSJ Symposium Series, INTERACTION2008, Vol.2008, No.4*, pp. 73-74.

Patten, J., Recht, B. and Ishii, H. 2006. *Interaction Techniques for Musical Performance with Tabletop Tangible Interfaces*. In *ACE 2006 Advances in Computer Entertainment*, Hollywood, California.

Piper, B., Ratti, C., and Ishii, H. 2002. *Illuminating Clay: A 3D tangible interface for landscape analysis*. In *Proceedings of the SIGCHI Conference on Human Factors in Computing Systems: Changing Our World*. ACM Press, New York, pp.355–362.

Smith, R.T., Thomas, B.H., Piekarski, W. 2008. *Tech-note: Digital Foam*. In *proceedings of IEEE Symposium on 3D User Interfaces*. pp. 35-38.

Suzuki, T., Tsunoo M., Kobayashi T., Irie K. 2001. *Info.Table: Realisation of Embedded Intelligence*. *Human-Computer Interaction, INTERACT'01*. pp. 809-810.

Wilson, A.D. 2005. *PlayAnywhere: a compact interactive tabletop projection-vision system*. *Proc. 18th annual ACM symposium on User interface software and technology*, New York, NY, USA, ACM Press, 83–92.

References from websites:

Apple Computer, Inc., *Logic Studio*.
<http://www.apple.com/logicstudio/>

Degidesign, *ProTools*,
<http://www.digidesign.com/>

High Resolution Co., Ltd., *MetaSynth*,
<http://uisoftware.com/MetaSynth/>

Steinberg Media Technologies GmbH, *CUBASE*,
http://www.steinberg.net/983_1.html

10. ACKNOWLEDGEMENTS

The authors thank Mr. Daisuke Kondo for his advice in the Duality Rendering method and Mr. James Lazo for his advice in writing this paper, and also are grateful to all persons concerned with this project.

INFOSPHERE: ONE ARTEFACT, TWO METAPHORS, THREE SORT CRITERIA.

J.Y Blaise^a, I.Dudek^a, T.Driscu^a

^a UMR CNRS/MCC 694 MAP, 184 av de Luminy, 13288 Marseille, France - (idu, jyb)@map.archi.fr

KEY WORDS: Visual metaphors, information visualisation, interfaces, Document search and retrieval

ABSTRACT:

Because investigations about sites or artefacts require collecting and sorting out distributed and heterogeneous pieces of information, the handling of these pieces of information has, with the development of information technologies, opened a number of research issues. We focus here on the interfacing of collections through visual means. We introduce Infosphere, an experimental disposal aimed at sorting out and visualising the information behind heritage artefacts or sites. Infosphere combines a 3D metaphoric model of the artefact under scrutiny, a geovisualisation metaphor (parallels/meridians of a globe), with parallels, meridians and diameter of the globe corresponding to sort criteria (discrete elements of the artefact's morphology, documents, time). The disposal is evaluated on the "signal light tower" in Marseilles, a XVIIth century edifice barring the entrance to the city's port.

1. INTRODUCTION

1.1 Objective

Investigations about sites or artefacts often start with the cumbersome task of collecting and sorting out distributed and heterogeneous pieces of information. Once this is done, structuring, summing up and/or giving access to the information is yet another challenge, intersecting issues from the field of knowledge and information visualisation. Finally, expert interpretation of the information sets may help in proposing and documenting reconstruction hypotheses, with possible corresponding 3D simulations targeted at a wide audience.

But these steps often correspond to alternative competences and moments in the study. As a consequence, although steps of this iterative workflow should command and complement one another, methods and results are rarely integrated. At the end of the day, 3D models overlook doubts and information lacks, the structuring of data sets neglects the "3D + time" nature of its content, etc. As a possible answer, we have in recent works proposed a methodological framework, at the intersection of the fields of architectural modelling and of information visualisation (Dudek, 2007), based on the idea that an analytical description of the artefact can be used to integrate distributed and heterogeneous pieces of information.

In this paper, we introduce an experimental disposal called **Infosphere** through which documents about an artefact under scrutiny are visualised and retrieved inside a 3D interface. The disposal bases on the hypothesis that for each document in a data set a corresponding element of the artefact under scrutiny can be found (edifice as a whole, parts, details, etc.).

Infosphere is designed as a tool helping to sort out, visualise and retrieve documents concerning an artefact, according to three parameters: granularity of the architectural analysis, level of abstraction of the documents, and time slot concerned. Documents are positioned inside a 3D metaphoric display by an [x,y,z] triplet (materialised in the 3D interface by the intersection of parallels and meridians of a sphere); where [x] corresponds to a breaking down of a site into sub-elements (spatial granularity, more or less equivalent to level of detail), [y] corresponds to the level of abstraction of the documents

itself (from realistic representations to diagrammatic analyses), and where [z] corresponds to a given time slot.

The display is composed of two visual metaphors. The artefact itself is represented as a 3D metaphoric model positioned at the centre of the scene (see Figure 1). A sphere based on a second metaphor (parallels/meridians of a globe) encircles the first artefact's model.

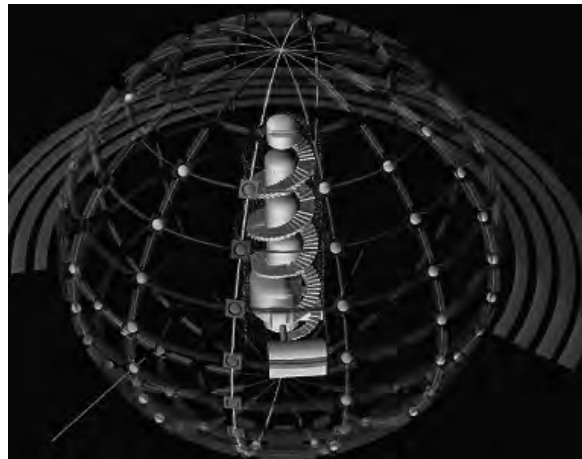

Figure 1: The two metaphors, with rings identifying time slots, and intersection points to retrieve documents.

The disposal is tested on the "signal light tower" in Marseilles, erected during the XVIIth century as a part of the fortification barring the entrance to the city's port, and serving as a lighthouse. The contribution first introduces this field of experimentation shortly. In section 2, we give a quick bibliographic overview, notably in order to position our understanding of metaphors. We then further detail in section 3 the disposal itself, and finally present elements of evaluation in section 4. In conclusion, we will insist on questions this experimental disposal raises in terms of data analysis, and in terms of readability of 3D scenes for use as interfaces.

1.2 Field of experimentation

One of the symbols of Marseille, Fort Saint-Jean guards the entry to the Vieux Port, the heart of the city. While it is a key element of the city skyline and its recognizable silhouette is present in many postcards, the interior of this old military garrison remains unknown to the public. This will change as the fort will become part of the future Museum of European and Mediterranean Civilizations.

Commissioned by the French king Louis XIVth, the fort was built between 1668 and 1671 onto a stretch of land that had previously belonged to the Knights Hospitaller.

With its counterpart, Fort St Nicolas on the opposite bank of the port, its role was to protect the entry to the harbour against enemies at sea but also to underline the power of the monarch over a notoriously rebellious population. Its design was later modified by Vauban in order to reinforce its defences, mainly towards the city.

Built on an elevated terrain on the northern shore of the harbour, the tower provides extraordinary panoramas over the sea and the port.



Figure 2: Clouds of points of the signal light tower (Tour du Fanal) and of the whole Fort Saint Jean (raw result of a laser scanning campaign) (UMR MAP, 2006).

The “signal light tower”, called Tour du Fanal, was built in 1644 as a watch tower and was later integrated into the fort. Its design, a stone cylinder containing five superposed circular rooms connected by a spiral staircase, did not suffer major alterations over the centuries.



Figure 3: A view from the inside of the signal light tower, showing the spiral staircase and the balcony on level 3 (UMR MAP, 2006).

During the last years the fort as a whole and the signal tower in particular have been studied by our institution, first by researchers and then more widely by post-graduate students for

whom it acted as a sort of test bench (notably of survey techniques). A very significant number of documents were produced as results of these actions. They include first and above all raw results of survey campaigns using photo-based techniques or laser scanning (Figure 2). They also include various results of data post-processing, ranging from panoramas (Figure 3) to detailed 3D models (Figure 4), or from 3D interactive promenades to full web sites and videos presenting the Fort’s history for a wide audience.

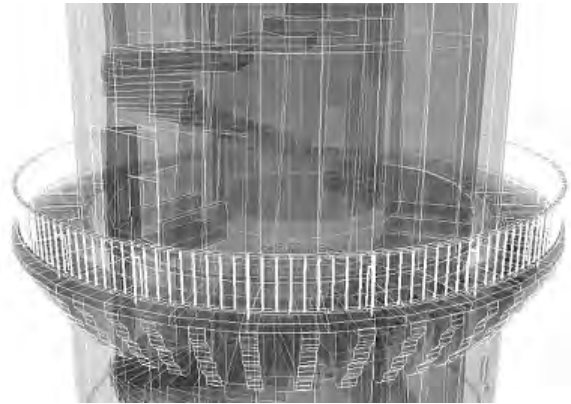

Figure 4: A partial view of a 3D model of the signal light tower, showing the balcony on level 3 and the spiral staircase (UMR MAP, 2006).

These recent documents should be understood as new inputs in the study of the site. Data was collected thanks to efficient survey techniques, but once post-processed it is scattered in a variety of formats (some commercial and some not) corresponding to a variety of objectives, and consequently forms a very heterogeneous documentation.

These recent documents are therefore not an end, nor are they the alpha and omega in understanding the signal light tower and its changes over time. They are just one more set of indications, with a good metric accuracy, that complements older studies and various heterogeneous archival materials about the site. In other words, because studies we conducted on the signal light tower were test bench studies more than an in-depth, organised investigation, both the “old documentation” and the recent one pose the same problem of heterogeneity. This is how we came with the idea of trying to experiment on this particular case a new visual disposal aimed at sorting out and at giving access to all these sources in a single interface.

2. ABOUT VISUAL METAPHORS

Visual metaphors are what (Kienreich, 2006) identified as one of the fundamental units of visual representation available to a designer. Visual metaphors base on real-world equivalents to display information. Their efficiency relies on the ability of the user to derive from his implicit understanding of the real-world equivalent an understanding of the semantics of the information set. Visual metaphors use analogies, and thereby rely also on intuitive behaviours. Consequently, they often require careful evaluation in order to judge of their efficiency in terms of information interfacing. As noted by (Kienreich, 2006), when drawing a visual metaphor, the designer has to make sure that a given metaphor is able to convey all relevant aspects of a information space before using it in designing a visualisation.

A lot has been done and written about visual metaphors, notably in the field of information visualisation, and (Lengler, 2007) “Periodic table of visualisation methods” (itself a metaphor, by the way) gives a good overview of their potentials uses, and relations to other visualisation methods.

The real-world equivalent behind a visual metaphor may have, or may have not, a direct relation with the information. As will be shown, we use this opposition in the following sub-section as a way to introduce the distinction we will make later on between our disposal’s inner metaphor, the artefact itself, and our disposal’s outer metaphor, a globe representation of earth.

2.1 Literal real-world equivalents

In most cases, visual metaphors rely on real-world equivalents that are used figuratively. A good example is the well-known family tree metaphor: children do not grow on branches, the tree is a figurative representation of parent/child relation. But visual metaphors can be used in the literal way: in (Göbel, 2003) a 3D virtual edifice acts as a library, with documents stored in drawers like in the real world. Users meander in the edifice in order to locate the storey, the room and the drawers they came to “borrow”. Another example, although more questionable, is (Heinonen, 2000) virtual city, where locating spots (*i.e.* information) in the city is done thanks to a simplified model of the city itself.

In our proposal, a 3D model of the signal light tower will be used as a literal real-world equivalent, illustrating the level of detail the user has chosen (Figure 5).

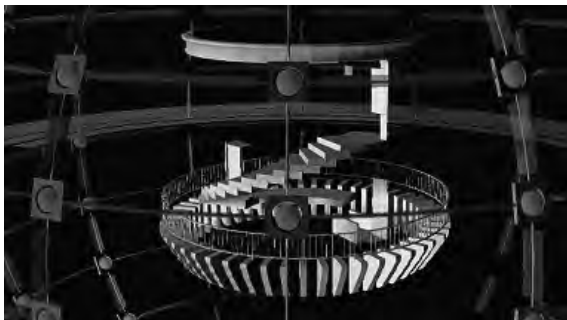

Figure 5: A view from the inside of the signal light tower, showing the spiral staircase and the balcony on level 3 (UMR MAP, 2006).

2.2 Figurative real-world equivalents

Choosing a figurative real-world equivalent means for the designer trying to find an “image” that best matches the information to deliver. Visual metaphors that rely on figurative real-world equivalent are omnipresent in communication, with questionable results sometimes when the image is not shared by the audience targeted.

Many architectural or urban spaces have been (and still are) used as figurative real-world equivalents, for instance in (Russo Dos Santos, 2001) where a virtual 3D city supposedly represents the various parts and elements of a computer.

Naturally, the more the information is rich and structured, the more visual metaphors use complex figurative real-world equivalents. A brilliant example of this can be found in

(Andrews, 2003) who introduce the *infosky* metaphors where clusters of stars and constellation help sorting out thematically articles. In our proposal, a 3D model of a geographic globe of planet earth will be used as a figurative real-world equivalent, considering that concepts such as “planet earth is round”, and “it is represented as a globe with parallels and meridians distributed on its axis” can be understood widely.

3. THE INFOSPHERE DISPOSAL

Infosphere is an experimental visual disposal aimed at sorting out and at giving access to documents about the site. It is applied here on the signal light tower for evaluation purposes.

It has to be stressed that **Infosphere** bases on the hypothesis that for each document there is a corresponding physical element of the edifice (may it be a detail, a part, the edifice as a whole, the ensemble to which the edifice belongs). For instance, the interactive panorama showing graffiti made by prisoners when the tower was used as a prison (Figure 6) are attached to a physical element (a storey’s interior space).



Figure 6: An extract of the graffiti visualisation

The following (Figure 7) will be attached to the opening itself (in the centre of the image), whereas a document like this on Figure 2 will be attached to the signal light tower as a whole. However, observing Figures 2 and 4, one can see that they differ not only in their “spatial granularity” (the former corresponding to the whole edifice, the latter to level 3 storey). They also differ by their “level of abstraction”: Figure 2 is raw data (result of laser scanning), and Figure 4 is an interpretation of the raw data, not comparable in terms of informative load.



Figure 7: A view of the east opening on level 0

Furthermore, archival documents will be sorted out in order to match a physical element but also a time slot, corresponding to the period they show. The reader should not underestimate the cost of sorting out the documentation using these three criteria. It is clear then why the **Infosphere** disposal is an experimental one, the consequences on documentation handling being important.

To sum it up, basing on these principles, the disposal sorts out and distributes information and documents using three criteria:

- To which discrete element (i.e. - level of detail) does the document correspond? (what we will call in the figure legends spatial granularity)
- What is the level of abstraction (i.e. - of human interpretation) of the document?
- What is the time slot shown?

The disposal should then allow the visualisation, and the downloading, of one or several documents corresponding to an x,y,z triplet. Each x,y,z triplet is materialised by intersection-points on the surface of the globe metaphor, where x identifies level of detail, y identifies the level of abstraction, and z (varying diameter of the globe) a time slot (Figure 8).

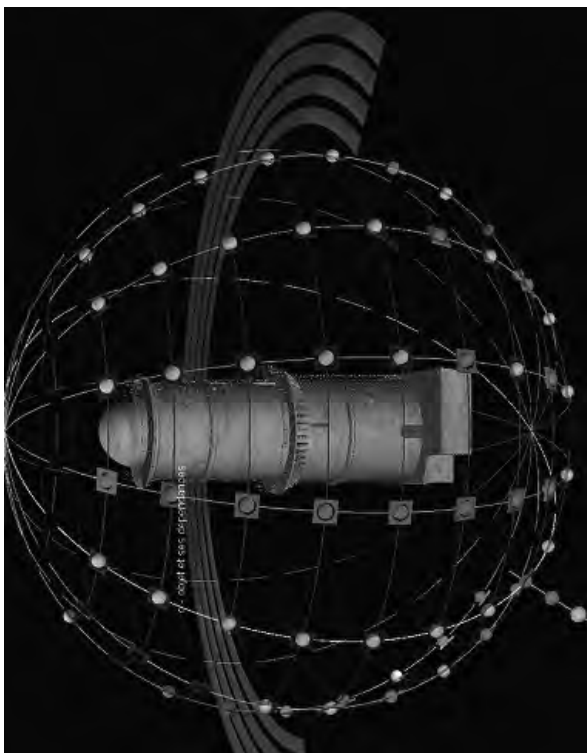

Figure 8: A screen capture of **Infosphere**. Note, in blue, meridians (x axis, level of detail), in red, parallels (y axis, level of abstraction) and rings to control z axis (diameter of the sphere, time slot). By selecting an x,y,z triplet (done by a click on an intersection-points), the user opens the blue line, (bottom left of the image) and interactively downloads a model of the tower acting as a metaphor for this x,y,z triplet. In the case illustrated here, x-spatial granularity artefact and its dependencies, y- level of abstraction raw photographic material, z- time slot present times. Highlighted in yellow by an onmouseover event, the selection's corresponding meridian.

At each x,y,z intersection an event-sensible intersection point is positioned, represented by a square and a sphere (see Figure 8, 9). The sphere is used to select an x,y,z intersection and to download the corresponding model of the signal tower (illustrating the spatial granularity for this intersection).

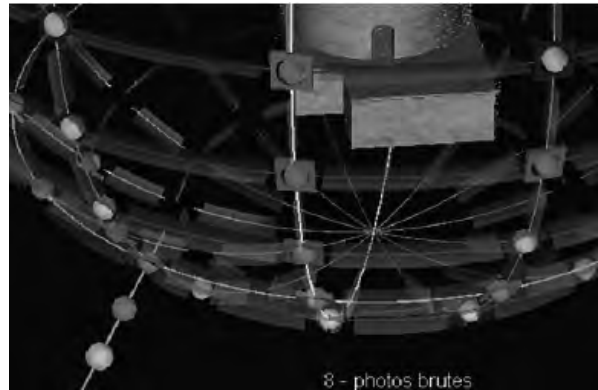

Figure 9: Selection of an intersection point resulted in interactive downloading of a model of the tower. In the case illustrated here, x-spatial granularity artefact and its dependencies, y- level of abstraction raw photographic material, z- time slot present times. Along the blue line marking the user's choice, other information available for the x,y intersection at different periods.

In addition, a click on the intersection point's sphere opens a blue line that helps the user know "where he is". Finally, along this blue line all the other intersection points corresponding to different periods are displayed for the user to see whether or not there are information corresponding to his [level of detail, level of abstraction] selection for other periods.

Evaluation section will show that although the learning curve is steep at start, the principles are in fact rather simple and rapidly understood. Squares and spheres marking intersection points have a colour code used to deliver some information either about the documents available or about the actions available:

- A green sphere is an intersection point where the user will find documents. A white sphere is an intersection where the user will find documents when the study will be over (i.e. we have documents, but still unloaded in the system). The absence of sphere (see Figure 10) means no documents have been found for the x,y,z triplet.
- Squares are used to focus on the intersection and then download the documents themselves (see Figure 11). When no documents can be downloaded for any period, squares are represented with a high level of transparency (see Figure 8). Squares represented as empty identify x,y for which documents are available only at a different period.

When users want to use the z axis, they can either select the rings or select intersection points scattered along the blue line. It has to be said that the readability of time changes is not yet satisfactory, as the evaluation will mention. A cloud of points can be used as a visual gauge of the edifice (see Figure 10).



Figure 10: Selection of an intersection point corresponding to the 1644-1668 period, with a number of inactive intersection points (absence of documents). In the case illustrated here, x-spatial granularity whole sites, y- level of abstraction plaster models, B&W graphics, z- time slot 1644-1668. Note, left, a column with coloured square: each of them corresponds to a graphic variable that users can interactively turn on / off , like for instance the radiating plates turned on in Figure 9 and off in this Figure.

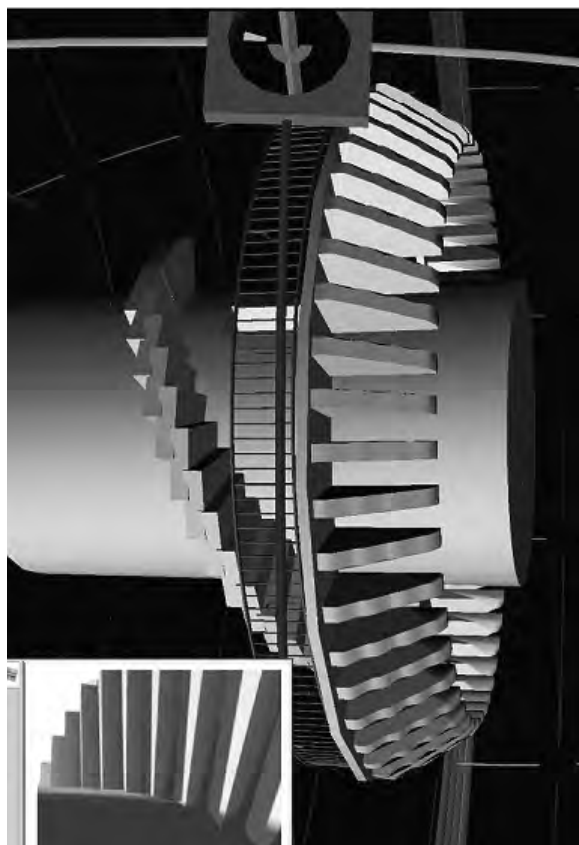

Figure 11: After selecting an intersection point by a click on the square, an automatic zoom puts the user in position to see the portions of disc that are nested inside the square. Each portion of the outer disc (here only one) corresponds to an individual document. Each portion of the inner disc corresponds to a collection (here two). Portions of disc correspond to URLs that are opened in a pop-up window (top left of the image, here a plaster-like model of the staircase).

Finally, it has to be stressed that the objective of the disposal includes, beyond sorting out and giving access to documents, gaining a global vision of our documentation.

Figure 12 compares the net of documents we have for the present times (left) with the net of documents we have for the previous relevant period (XIXth century): graphics talk by themselves. In other words, the disposal acts as an interface, but may be even more useful as an infovis disposal.

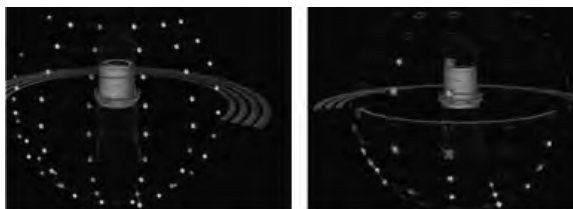

Figure 12: In the case illustrated here, x-spatial granularity canonical ensembles, y- level of abstraction raw photographic material , z- time slot present times on the left, XIXth c. right.

4. THE EVALUATION

Due to time constraints, at the time of writing the paper the evaluation was carried out with a only four post-graduate students, unrelated to previous actions on the site, who were given a half-page description of the system and given forms to fill in. Results should therefore not be overestimated; they only provide an indication of trend.

Five criteria were evaluated:

1. Readability of the metaphor.
2. Finding one's way in the disposal's space
3. Adjustment of graphic parameters
4. Efficiency in navigation
5. Efficiency in document retrieval.

For criterion 1, we checked whether the overall functionalities were understood (which axis is which, where can you download documents from, etc..). Results show a good understanding of the functionality, apart from time handling on the z axis for which we in 2 cases had to intervene.

For criterion 2 we checked how long it took to find the x,y intersection shown in Figure 1. Results are inconsistent, with answers ranging from less than 15 seconds to more than 45 seconds. They are inconclusive.

For criterion 3 we provide the two images in Figure 13, (a), asked which setting was best and asked them to fine-tune the interface using buttons shown on Figure 10. Results show less graphic elements are preferred (including for one evaluator absence of meridians and parallels), an empiric confirmation of E.R Tufte's (Tufte, 1997) data-ink ratio principle.

For criterion 4 we checked the time needed and the number of errors in selecting x,y intersections corresponding to Figure 13 (b). Average is more than one minute, and 4.5 errors, not a very convincing result.

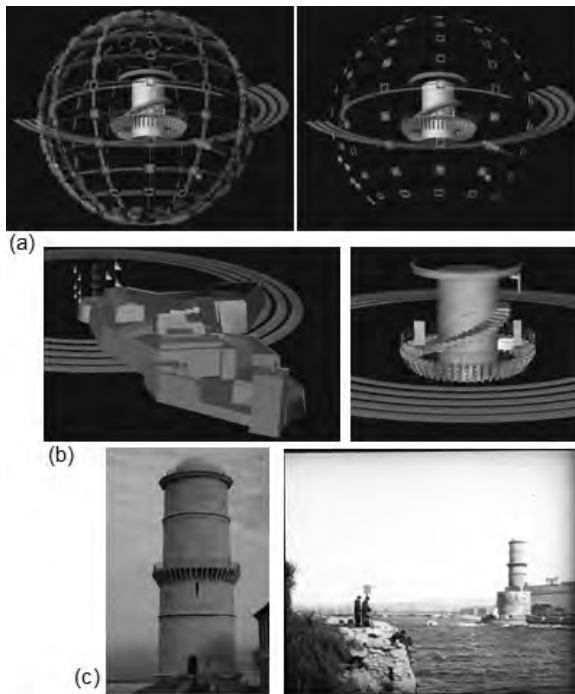

Figure 13: Examples given for the evaluation (criteria 3,4, 5).

The same principle was applied for criterion 5, where we checked the time needed and the number of errors in selecting documents in Figure 13 (c). Results are acceptable for the left document (contemporary) with an average one minute and 5 errors (compare this to existing solutions when handling heterogeneous data sets). Results for the right example (XIXth century period) are less convincing, with mistakes in finding the proper time slot (over 2 minutes, 4.5 errors).

Besides the criteria evaluation, qualitative input was asked, with interesting remarks collected on weaknesses of the disposal (ambiguities of the interface in showing the time slot observed, ambiguities of the attachment of documents to a given x,y,z triplet notably). On the overall, the approach was judged at first glance as almost “frightening”, and once understood as a promising way of handling data. It has to be said that although we have a significant number of sources available in the system (over 500), their diversity and distribution in time has yet to be better exploited before going further in the evaluation.

5. LIMITATIONS AND CONCLUSION

It would take pages to analyse the limitations of this disposal, and to separate limitations due to the field of experimentation itself, to the implementation, and those really due to the infosphere “concept”.

Let us here still quote some: cost of course (architectural modelling), time granularity problem (what when we have 30 periods of interest for an edifice) sorting and inconsistency problems in the documentation, etc.

We are well aware that the disposal is experimental, and that a number of weaknesses exist; however we think that even in this rather early stage it does push to the fore ideas that might prove

fruitful. In conclusion, we would like to underline some benefits of general interest that the experimental disposal let us identify:

- Sorting out heterogeneous documents using architectural shapes is efficient, although costly.
- Learning curve of 3D displays can be reduced by using visual metaphors.
- An interface that can also provide information visualisation service is better.
- Evaluating visual disposals is useful (sic.)

6. REFERENCES

Andrews, K., Becker, J. Kappe,F. et al., 2003. Infosky: visual exploration of large hierarchical document repositories, In : *Proc. HCI'03*, Crete, Vol.3, pp. 1268-1272

Blaise, J.Y, Dudek, I., 2007. Informative Modelling, *MiaJournal* Vol. 1S, pp. 143-154.

Göbel, S., 2003. GeoLibrary: Metaphor-based Information and Navigation Space to Access GeoData Archives, In : *Proc. I-Know 03 Conference*, JUCS/ Graz, pp. 121-127.

Heinonen, A. et al., 2000., An Information database for VRML Cities. In: *Proc. IV 2000*, London.

Kienreich, W., 2006. Information and Knowledge Visualisation: an oblique view, *MiaJournal*, Vol. 0, pp. 7-16.

Lengler R., Eppler M., 2007. Periodic table of visualisation methods, <http://www.visual-literacy.org/> (accessed 23 Jun 2008).

Russo Dos Santos, C., et al., 2001. Dynamic Information visualisation Using Metaphoric Worlds. In : *Proc. VIIP 2001*, Marbella, pp. 60-65.

Tufte, E.R., 1997. *Visual explanations*. Graphic Press, Cheshire.

UMR MAP, 2006. Surveys and data post-processing are achievements of the post-graduate DPEA MCAN one year courses within the UMR CNRS/MCC 694 MAP, M.Berthelot (courses director), T.Driscu (see www.map.archi.fr for other credits and details).

7. ACKNOWLEDGEMENTS

This experimental visual disposal reuses material (raw surveys and data post-processing like panoramas, 3D models, etc..) that are achievements of staff and/or students of a post-graduate programme within UMR MAP. Also done within the framework of a research programme supported by Regional authorities (Région PACA).

LIBVIZ: DATA VISUALISATION OF THE OLD LIBRARY

K. Ruhland^a, M. Sedlmair^c, S. Bioletti^b, C. O'Sullivan^a

^a GV2, Trinity College Dublin, College Green, Dublin 2 - (ruhlandk, Carol.OSullivan)tcd.ie

^b Preservation and Conservation Dept., Trinity College Dublin, College Green, Dublin 2 - bioletts@tcd.ie

^c Media Informatics Group, Institut für Informatik, Amalienstraße 17, 80333 Munich - michael.sedlmair@ifi.lmu.de

KEY WORDS: Visualisation Techniques, Data Management and Archiving, Interactive Applications

ABSTRACT:

The Old Library of Trinity College Dublin, built in 1732, is an internationally renowned research library. In recent decades it has also become a major tourist attraction in Dublin, with the display of the Book of Kells within the Old Library now drawing over half a million visitors per year. The Preservation and Conservation Department of the Library has raised concerns about the impact of the environment on the collection. The location of the building in the city centre, large visitor numbers, and the conditions within the building are putting the collection at risk. In developing a strategic plan to find solutions to these problems, the department has been assessing and documenting the current situation. This paper introduces ongoing work on a system to visualise the collected data, which includes: dust levels and dispersion, internal and external temperature and relative humidity levels, and visitor numbers in the Old Library. We are developing a user interface for which the data, originally stored in various file formats, is consolidated in a database which can be explored using a 3D virtual reconstruction of the Old Library. With this novel technique, it is also possible to compare and assess the relationships between the various datasets in context.

1. INTRODUCTION

Built in 1732, the Old Library at Trinity College Dublin (TCD) was originally designed to provide storage, reading and tutorial spaces for the growing College Library collection, staff and students. It was also designed in such a way as to maximise the use of some of the features of the building to provide protection for the books. Large sash windows provided natural light for reading, thus negating the need for oil lamps and allowing air circulation to prevent the possibility of mould; the Long Room itself was located on the first floor of the building, above a colonnaded walkway to reduce the risk of flooding. However, over the years, new risks to the collection have emerged which were not foreseen, including the growth in external pollution levels, the impact of continued exposure of collections to natural light, the effects of changing temperature and humidity levels on bindings and paper, and the new use of the building as a public space.



Figure 1: The Long Room (Trinity College)

The Preservation and Conservation Department of the Library is collaborating with the Director of Buildings Office and various science departments in the College, to undertake a

detailed assessment of the building, including a full structural survey and building performance review, a visitor impact study and a study of the environmental conditions. The results of these investigations will inform the Old Library Preservation strategy, which aims to protect both the building and its contents into the future.

Maintaining an appropriate environment for historical buildings with respect to preservation and usage has been the focus of many studies. At TCD, the Preservation and Conservation Department has been monitoring temperature and relative humidity in collection areas, and has recently commenced a study of Old Library Dust (SOLD), in partnership with the Geochemistry Laboratory in the Department of Geology. This study aims to identify the type, source, volume and distribution of particulate pollution within the building. An initial study was carried out to determine the levels and content of existing dust, prior to establishing the study of ingress rates and pathways and distribution patterns (Trinity College). Other investigations include a study of the paper and dust interface (SPD) and the presence of volatile organic compounds in the Old Library, which are being carried out in collaboration with partners.

Related studies include an investigation into the ceremony room of the mediaeval palace in Padova, which focused on "the impact of lighting, heating and people in re-using historical buildings" (Camuffo, 2004). Decorations on the walls, paintings on the ceiling and stained-glass windows are important features in the room, which is used as concert hall. Results of a microclimate study confirmed that the light from lamps and sunshine through the windows were damaging the frescoes. Scatter diagrams of the daily relative humidity and temperature cycles were used to illustrate the effect on the wooden coffered ceiling. Conclusions led to recommendations which would enable Padova to preserve the artwork as well as provide an acceptable environment for visitors.

In this paper we present the LibViz system, collaboratively designed with the Department of Computer Science and the Preservation and Conservation Department. In LibViz, a 3D model of the Old Library is used, along with appropriate types of information visualisation methods that represent a variety of environmental and structural data in a graphic way. The aim is to allow the conditions of the Library to be analysed and interpreted as the user interactively navigates through the model.

The remainder of this paper is organised as follows. In the next section we provide background information. Section 3 gives an overview of our preparatory work, while Section 4 describes the current state of the application. We conclude in Section 5 and discuss further ideas that could make the application as useful as possible.

2. BACKGROUND

The use of information and communication technologies for cultural heritage offers a lot of new potential. With the DigiCult project, the European Union supports research into accessing, experiencing and preserving cultural and scientific resources (DigiCult). The main research topics covered are: digital library services for digitisation and restoration of cultural and scientific resources; discovering new digital representations and reconstructions of archaeological sites and artefacts; and new techniques to support the long-term preservation of cultural information (DigiCult). The project AGAMEMNON, for example, involves the development of a 3G mobile application as an online guide for archaeological sites and museums. The application not only provides a personalised tour path based on a visitor's profile, it also assists in the preservation of cultural heritage. Through image-based monitoring techniques, the application can inform the user of signs of deterioration or erosion. Improvements to the site management can be made through tracing and analysing visitor's behaviour and preferences (AGAMEMNON).

Another approach is to establish standards "for the use of 3D visualisation in the research and communication of cultural heritage" as described in (The London Charter). Here, the aim is to provide a benchmark to ensure that the use of 3D visualisation methods is intellectually and technically rigorous. The charter also seeks to establish a platform to evaluate and understand the methods used for research and communication of cultural heritage, and to fully integrate these methods into this domain. Eight principles are presented: the subject communities, available aims and methods, relevant sources, transparency requirements, sufficient documentation, standards, long-term sustainability and accessibility.

Computer visualisation techniques are widely used to virtually reconstruct archaeological sites, to illustrate artefacts or to get an impression of how it could have looked hundreds of years ago. The virtual reconstruction of the Ancient Egyptian Temple of Kalabsha (Sundstedt, 2004) made it possible to display the original location and orientation of the temple which had to be moved to prevent it from disappearing under the waters of the Nile. In (Kwon, 2001), a virtual heritage system is used to generate 3D models of cultural heritage, manage the virtual models over a database system and provide an interactive presentation of the reconstructed environment.

Since we have to deal with a large amount of different kinds of data and their representation, information visualisation methods are particularly relevant for the development of LibViz.

A variety of conventional static visualisation techniques already exist to help users explore their data. Mapping time on a quantitative scale leads to Time Series Graphs in 2D or 3D and, depending on the available data, to Point Graphs, Line Graphs or Circle Graphs (Schumann, 2004). With a Change Chart or Stacked Bar Chart, the total amount of data is represented as a single bar and the increases at each time step as a colour or texture.

More advanced visualisation techniques include the presentation of multivariate data over time, where a data element at a specific time stamp covers data values of several variables. ThemeRiver™ (Havre, 2000), for example, was first developed for document visualisation, to identify the frequency and appearance of special words in documents. A "river" of themes flows left to right through time. Themes are distinguished by different colours. Changes in the bandwidth of the river indicate the overall strength of the selected themes. Equally, a change in the bandwidth of an individual theme indicates the theme strength at any time stamp. Another effective method to analyse more than one variable is MultiCombs or TimeWheels (Schumann, 2004). Time plots of each different variable are arranged circularly on the display, with the variable axis pointing outwards from the centre or with the time axes in the centre and the other axes circularly arranged around it.

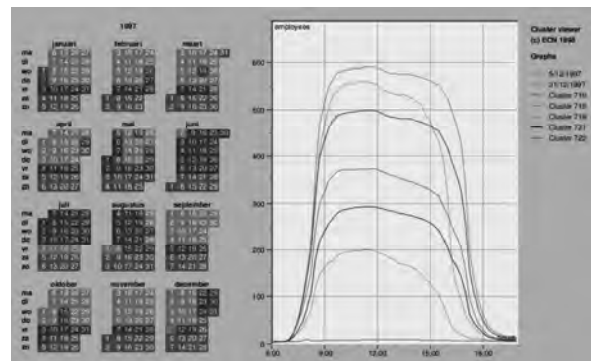

Figure 2: Calendar View (van Wijk, 1999)

These presentation methods can be used to explore a single dataset over time. A more advanced approach is the Calendar View (van Wijk, 1999). This method allows the user to simultaneously identify patterns and trends on multivariate data. Similar daily data patterns are clustered and presented as a graph, with the corresponding days on a calendar (see Figure 2). The same colour is assigned to corresponding clusters and patterns. The selection of a specific day in the calendar produces the visualisation of the day's graph. Otherwise, with a single button press, the user can recursively ask to highlight all days with similar properties. Besides using an isolated 2D presentation, the data can be presented in its spatial context. Lexis Pencil (Brian, 1997) is an example of a visual metaphor, where different time-dependent variables are mapped to the faces of a pencil which can be located in 3D space.

To switch between the various 2D and 3D data in multiple windows, an intuitive method must be found to propagate

changes made in one window to the other ones. In the area of Coordinated and Multiple Views (Roberts, 2007), various methods exist for interacting with and manipulating multiple windows. The user can filter or select displayed data and can change, for example, the colour map and how (s)he navigates through the system. With the so-called brushing technique, the user can select an element in one view and simultaneously all information in the other views are adjusted (Becker, 1987).

3. PREPARATORY WORK

To satisfy the user a requirement of this application, a list of basic functionality was compiled (Ruhland, 2007). This list includes controls to navigate through a 3D model of the Old Library, cutaway views of the model to examine specific regions, the ability to visualise installed sensors and their values, and the ability to query information about objects, such as windows.

The 3D model of the Library was made in Autodesk 3ds Max and mostly consists of simple geometric forms. Since no accurate building plans were available for this project, the dimensions were either measured with a laser meter or calculated from images with the software Datin[®] Measure (DatInf GmbH). A short animated film was made to provide an impression of the 3D model*. Rendering with the global illumination renderer Mental Ray, a daylight system casts patterns of sunlight through the windows onto the floor.

The application itself was implemented in C++ and OpenGL. Using MAXScript, the built-in scripting language of 3ds Max, a script was written to export the model from 3ds Max to a custom file format which could then be loaded into our application. Similar to computer game controls, the mouse and keyboard keys can be used to control a free-roaming camera for navigating through the 3D model.

For user interaction we used GLUT, a GLUT-based C++ library (Rademacher). The user can navigate through the 3D model with widgets for rotation and translation, or jump to a predefined location within the model, which is of benefit to users who are not used to computer games controls. The visualisation of the position of installed sensors is also possible, and by activating the clipping slider the user can cut through the building to inspect occluded locations. The user can also directly select an object on the screen by clicking on it.

Our basic version of LibViz provided several visualisation features. For example, the measured concentration of dust on each bookshelf in the Long Room can be visualised as spheres that are coloured according to concentration and positioned at the bookshelf where the measurement was taken. By selecting a window, the user can examine the state of each pane. Also, the locations of sensors that measure general data, light levels and relative humidity can be visualised (Ruhland, 2007).

4. CURRENT STATUS OF SYSTEM

Evaluation of the preliminary version of LibViz described in Section 3, along with the identification of new requirements, led to the design of the second system prototype. The main components updated were: rendering the model, executing database requests, handling the plug-ins and visualising data.

The 3D model of the Old Library is made up of 1,028 objects, 248,952 vertices and 443,027 faces. The model is divided into three parts which are stored in individual files. One of them stores the texture names, vertices, faces and texture coordinates of the windows, which are rendered with a opacity of 70%; another stores the data for the bust model which is instantiated multiple times in the Long Room; and the third stores the rest of the building geometry. Various techniques are used to accelerate the rendering performance. We use OpenGL display lists extensively so that particular objects are optimised and stored on the graphics card for fast display. Given that thirty-six busts are located in the Long Room and each of them is made up of over 6000 faces, it would be costly in terms of performance to render them all in real-time in OpenGL. As the Long Room of the Library is symmetrical, display lists make it easy to replicate a single bust model at different positions along the aisles of the Library using simple OpenGL transformations. Further improvements were made through the use of view frustum culling techniques.

In preparation for visualising the necessary information and populating the system, the recorded data stored in a variety of file formats is transferred into a database. The Preservation Department of the Library provided us with the information they wished to visualise in the form of multiple Excel spreadsheets and plain text files. For the purposes of comparing or filtering the data from various sensors, sliding through time or searching for specific data, the given files were not in a usable format. Therefore, these data was transferred to an SQL database, both by hand and with the help of proprietary data conversion tools. For the database software we chose SQLite (SQLite). Considering the volume of data to be used in LibViz, SQLite provides a small, fast alternative SQL database, which is simple to administer and implement and runs without a server or any complex configuration requirements. The resulting database can be processed directly by our application using SQL like syntax.

To make the application as extensible as possible, a special interface connects new plug-ins with the application. So far, seven plug-ins have been implemented which handle the information visualisation of the window survey, the dust survey and study, information of the light levels, temperature and relative humidity sensors and additional data about visitor statistics and external weather data. New plug-ins can easily be added without changing the main application. All plug-ins are stored as dynamic link libraries (DLL) in a separate directory. At run-time, the application scans the directory for available DLL files and registers these as plug-ins with the main application. Developing a new plug-in has to follow certain restrictions. Each plug-in is assigned a unique name, which appears as a label in the list of all plug-ins. Two functions have to be implemented; one draws 3D objects on the screen; the other draws and controls the plug-in GUI. The position of the plug-in widgets is calculated automatically by the application. This plug-in system enables third-party developers to extend the application or to update a single entry dynamically, thus

* A movie showing the model is available from <http://isg.cs.tcd.ie/projects/OldLibrary/>.

reducing the size of the main application and allowing unused features to be easily removed.

Using GLUI as the graphical user interface for the application proved somewhat restrictive, as choosing between different tasks and providing a well arranged user interface requires special functionality. In LibViz, we developed our own GUI using an "immediate mode GUI" (IMGUI) approach, which differs from the traditional, retained mode approach used by GLUI and most other user interface toolkits (Komppa, 2007). This approach provided complete control over the appearance and placement of GUI widgets. In particular, since the information we visualise is read from a database and processed by plug-ins, it was important to provide a means to dynamically add, remove, and arrange widgets on the screen with as little overhead as possible. The IMGUI paradigm is suitable for this and does not require the user to arrange widgets using a layout editor ahead of time. Furthermore, it allows us to draw transparent widgets over the 3D model of the Library and the look and design of the GUI widgets and its elements (buttons, sliders, etc.) can be easily customised.

Initially two widgets appear in the application (Figure A.1). One widget contains global functions like navigation controls, a clipping slider and an exit button. The other shows a list of buttons that can be used to activate the various plug-ins. Selecting a specific plug-in opens an associated widget with detailed information. Selecting objects from the screen by clicking on a part of the building or a window displays the information corresponding to this object. The two initial widgets can be minimised and all other widgets can be closed as well.

In LibViz we make use of a variety of information visualisation techniques to help us answer questions such as:

- Where are there anomalies in the recorded temperature or relative humidity data?
- Are there correlations, e.g. between the inside/outside environment and the number of visitors?
- Why do environmental conditions drift outside given parameters at particular times of the year, or due to particular events?
- Is there a cyclical pattern to the observed data?
- Is there a relationship between influencing factors such as dust dispersion and visitor pathways, and/or building structure?

At this stage we provide the user with the following information:

Window Survey: The user can select a window by clicking on the "Window" button, which opens a list of all window names or by picking the window on the screen. The selected window is highlighted and a detail widget opens (Figure A.2). On the left hand side of this widget the state (cylinder, modern or cracked class) of each window pane is shown. The right side shows the window frame survey. The user can change between the details for the internal and the external frame.

Rough Dust Survey: Activating the Dust Sensor button causes coloured spheres to be drawn on the bookshelves in the Long Room model where the dust was measured, along with a description of the colour code used. The colour indicates the concentration of dust (slight, moderate and severe). Choosing a

bird's eye view camera position and using the clipping slider (Figure A.4) allows the user to slice through the building to get a overall impression of the dust dispersion. Selecting a specific dust measurement point opens a widget with detailed information (Figure A.5).

Dust Accumulation: This option presents the result of the pilot scheme to monitor the rate and distribution of dust by reflectivity or "loss of gloss". Forty glass slides are distributed in the Long Room and the Gallery. In three monthly intervals new measurements are taken. The locations are visualised as spheres with the colour code of the last measurement (Figure A.6). In addition, the visitor data and external weather data is displayed in a separate widget. Sliding through time adjusts the colour of each sphere to the new measurement and the additional data. Two bar graphs can be chosen to display the rate of "loss of gloss" over the stalls in the Long Room and the Gallery. A time graph shows the changes between the measurements for specific selected slides. Like the rough dust survey, the user can inspect the data in the virtual environment.

Temperature and Relative Humidity: Activating the Temperature and Relative Humidity button causes coloured cubes to be drawn at the position where the sensors are located in the building. In addition, a list of all sensors is presented. Selecting a sensor, either from the list or by clicking on the cube in the 3D environment, opens the "Calendar View" with the time graph for temperature over the year (Figure A.3). Moving the mouse over a graph point displays the exact value. Initially the "Calendar View" shows the colour code of the average temperature for each day. Using check boxes, the user can decide if the calendar and the graph should show temperature, relative humidity or both. Additional data about the visitor numbers and external weather data is shown in a separate widget. Selecting a specific year, month, week or day changes the visualisation of the graph, the additional data and the colour code of the sensor cubes in the 3D environment. The sensor cubes always show the colour code of the average data over the selected time frame for temperature in the lower half and relative humidity in the upper half.

Extra Data: As soon as a date is set, a separate widget opens to present the visitor numbers and external weather data of this date (Figure A.3). The weather data is provided by the Irish Meteorological office and contains temperature, relative humidity, sunshine hours, amount of rainfall, maximum wind speed and wind direction.

Light and Data Sensors: Activating one of these functionalities over the corresponding button causes coloured spheres (yellow, grey) to be drawn at the exact position of the sensor category in the building. In addition, a list of the activated sensors is drawn.

5. CONCLUSION AND FUTURE WORK

In this paper we have presented LibViz, an application to visualise recorded data in the Old Library of Trinity College Dublin. Based on a 3D model of the Library, the user can navigate through various information sources relating to dust dispersion, temperature, relative humidity and visitor numbers. We have presented a stable system design to deal with the performance-related management of the Library's large 3D model and demonstrated the integration of 2D information via selectable plug-in widgets. Seven plug-ins were implemented to

offer detailed information about the recorded data. Our plug-in approach is fully extensible and provides a simple interface for third-party developers. Furthermore, we consolidated the dispersed data sources and integrated them into a single database to offer consistent information access. For future work, we plan to enrich our concept with further information visualisation techniques.

Assisting the Library in studying the impact of environmental conditions on the building and its contents will be the main goal for the future. Thus, our work will also address the use of computational fluid dynamics (CFD) to analyse the fluctuations of temperature and relative humidity, which will help to identify the most vulnerable regions in the Library. CFD in combination with predictive modelling could also help guide recommendations for changes to the Library. Similarly, studying the effects of alterations to the building layout, or the heating and ventilation systems, would benefit the preservation strategy. Further information about the movement of visitors in the Library, extracted from videos, could help to identify why certain areas have higher levels of dust. It would be interesting to simulate the settling pattern of dust after it is dispersed by people's footsteps, or to answer questions about the average length of a visit in the Long Room and the way in which visitors move through the space.

The integration of the sensors' live data stream from the Library into the system is also of great interest. Browsing the data in real time would allow the user to react immediately in the case of an anomaly or a possibly hazardous situation.

The incorporation of further visualisations methods will allow LibViz to become an effective tool to assist in the future preservation of the Old Library and its collection. The application will grow over time as its user base increases and more functionality and features are needed.

6. REFERENCES

- AGAMEMNON Citizen Charter, IST-508013-STP, <http://services.txt.it/agamemnon/citizen.htm> (accessed 18 June 2008).
- Autodesk: Tutorials that ship with 3ds Max 9 software.
- Becker, R.A., Cleveland, W.S., 1987, Brushing scatterplots, *Technometrics (JSTOR)*, Volume 29, Number 2, pp. 127-142.
- Brian, F., Pritchard, J., 1997. Visualisation of historical events using Lexis pencils. *Case Studies of Visualization in the Social Sciences*, http://www.agocg.ac.uk/reports/visual/casestud/francis/conten_1.htm, (accessed 25 June 2008).
- Camuffo, D., Pagan, E., Bernardi, A., Becherini, F., 2004, The impact of heating, lighting and people re-using historical buildings: a case study, *Journal of Cultural Heritage* 5, pp. 409-416.
- Clarke, A., 1986: *Treasure of the Library*. Trinity College. DatInf GmbH, Tübingen, Datinf@Measure, <http://datinf.eu/pages/products/datinf-measure/ntroduction.php>, (accessed 18 June 2008).
- DigiCult, Cultural Heritage & Technology Enhanced Learning, http://cordis.europa.eu/fp7/ict/telearn-digicult/home_en.html, (accessed 18 June 2008).
- Komppa, J., 2007, Sol::Tutorials - Sol on Immediate Mode GUIs (IMGUI), <http://sol.gfxile.net/imgui/index.html>, (accessed 18 June 2008).
- Kwon, Y., et al., 2001, Virtual Heritage System: Modeling, Database & Presentation, *Proceedings of the Seventh International Conference on Virtual Systems and Multimedia*, pp. 137-146.
- Havre, S., Hetzler, B., Nowell, L., 2000, ThemeRiver: Visualizing Theme Changes over Time, *Proceedings of the IEEE Symposium on Information Visualization*, pp. 115.
- Rademacher, P., Glui user interface library, <http://www.cs.unc.edu/~rademach/glui/>, (accessed 18 June 2008).
- Roberts, J., 2007. Coordinated and Multiple Views In Exploratory Visualization, *Proc. CMV 07*, Volume 7, pp. 61-71.
- Ruhland, K., Bioletti, S., O'Sullivan, C., Hussmann, H., 2007, LibViz: A visualisation toolkit to support the Preservation of the Old Library, *Eurographics Ireland Workshop*, pp. 60 - 66.
- Schneiderman, B., 1996. The eyes have it: a task by data type taxonomy for information visualizations. *Visual Languages, 1996. Proceedings., IEEE Symposium*, pp. 336-343.
- Schumann, H., Mueller, W., 2004. Information Visualization: Techniques and Perspectives. *it-Information Technology*, 46(3), pp. 135-141.
- SQLite, 2008, <http://www.sqlite.org>, (accessed 19 June 2008).
- Sundstedt, V., Chalmers, A., Martinez, P., 2004. High fidelity reconstruction of the ancient Egyptian temple of Kalabsha. *AFRIGRAPH '04: Proceedings of the 3rd international conference on Computer graphics, virtual reality, visualisation and interaction in Africa*, pp. 107-113.
- The London Charter, v.1.1, <http://www.londoncharter.org/>, (accessed 18 June 2008).
- Trinity College Library Dublin, Preservation and Conservation department, <http://www.tcd.ie/Library/Preservation/> (accessed 18 June 2008).
- van Wijk, J., van Selow, E., 1999. Cluster and Calendar based Visualization of time series data. *IEEE Symposium on Information Visualization (INFOVIS)*, San Francisco, pp. 1-6.

7. ACKNOWLEDGEMENTS

The authors would like to acknowledge Robbie Goodhue, principal scientist for the Study of Old Library Dust (SOLD); David Fitzgerald, Aidan Murphy and Noreen Brennan, from Met Éireann; and Richard Lee for his help and advice.

This project is supported by the Trinity Long Room Hub initiative, which is in turn funded by the Higher Education Authority.

APPENDIX A. SCREENSHOTS



Figure A. 1: LibViz: Front View



Figure A. 4: LibViz: Dust Survey (Birds Eye View)

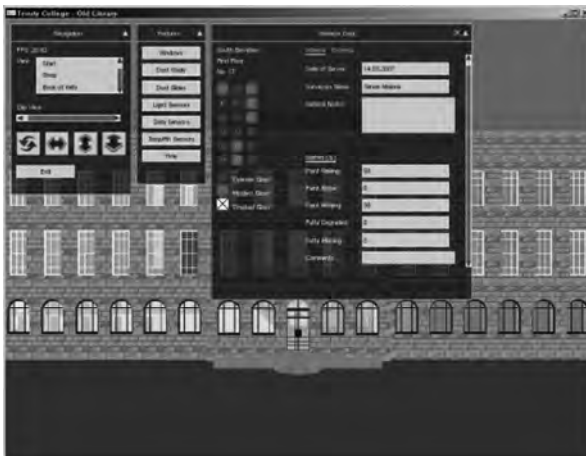

Figure A. 2: LibViz: Window Survey



Figure A. 5: LibViz: Dust Survey



Figure A. 3: LibViz: Relative Humidity Sensors



Figure A. 6: LibViz: Old Library Dust (SOLD) Study

3-DIMENSIONAL HOLOGRAPHIC REPRESENTATION OF MUSEUM OBJECTS

V. Tornari^{a,*}, E. Tsiranidou^a, K. Hatziyannakis^a

^a Institute of Electronic Structure & Laser - I.E.S.L, Foundation for Research and Technology Hellas - FO.R.T.H,
Vassilika Vouton, GR 71110, Heraklion, Crete, Greece - vivitor@iesl.forth.gr

KEY WORDS: Reflection holography, 3-dimensional representation, museum object

ABSTRACT:

The three dimensional information of museum objects and immovable heritage is a critical parameter that holds the realistic representation of the cultural treasure for educational, communicational and historical values. Fully three dimensional objects like sculptures, statues, vessels etc. are represented with two dimensional photographs or in more advanced cases with stereoscopic, virtual or pseudo-three dimensional reconstructions. The ideal scenario of real three dimensional reconstructions has a long way to go before it could be an everyday reality in our screens. However, a solution from a well known technique which can record and reconstruct in full parallax the depth information is further exploited. The technique of optical holography remains the only way to acquire the optical wave carrying the three- dimensionality of the object. This optical wave is used to store, share, reconstruct, educate and advertise objects of cultural interest.

1. INTRODUCTION

The term holography signifies the writing of the whole information (holo = όλο - whole / -graphy = γραφή - writing) of the light. This term in contrast to photography (photo = φως - light / graphy= γραφή - writing) indicates the additional recording of the phase which is the property of light carrying the depth information and optical path variations, (Kock, 1975; Saxby, 1994; Fotakis, 2006). In visual terms by recording the phase of the transmitted or scattered light from an object a record of the three-dimensional information is obtained. In optical coherent terms it is the objects wavefront which is being recorded by interference and reconstructed by diffraction. Indeed the reproduced hologram is the exact replicated wavefront of the light that was modulated by the object's volume at the instance of recording. Thus by holography it is recorded, the frequency, the polarisation, the phase information and the amplitude of the light used.

Hologram Properties
1. Lensless imaging
2. 3 Dimensional imaging
3. 1 to 1 scale reconstruction
4. Multiple point interference
5. Multiple image interference
6. Paraxial viewing
7. Interconnection of information

Table 1. Properties of Holograms

Holography is a very well known technique for the unique property of being three-dimensional and yet remains the only wavefront reconstruction method. It involves unique properties for each one of which a separate chapter may be devoted but for reasons of brevity here are summarized in table 1. The properties can allow a three dimensional representation of a museum object or replica to:

- Be shared in many copies around the world
- Be studied in full horizontal and vertical parallax
- Warrant the object's information, since even a small part can reconstruct the whole record from the angle of viewing
- Archive the spatial information of an object and reconstruct it
- Be enjoyed in its three dimensions in a lightweight piece of film

2. EXPERIMENTAL METHODOLOGY

Holography is a technique for recording and reconstructing light waves. The wave, which is to be recorded, is called object wave. In order to reconstruct that is, produce a replica of the object wave, it is sufficient to reproduce its *complex amplitude* U_o , at one plane in space. Once this has been reproduced, the light propagating away from this plane will be identical to the original object wave. The distributions of both real amplitude and phase must be recorded. However, photosensitive mediums or detectors respond only to irradiance and the frequency of light is approximately 10^{15} Hz. Practical detectors such as photographic film, photodiodes, or the retina of the eye are not capable of responding to such extremely rapid variations. Rather they respond to *irradiance*, which is the time-average energy flux of the light wave. So the object wave irradiance, $I_o=U_oU_o^*$, is a real quantity and a film exposed to U_o can record the distribution of real amplitude but the distribution of phase will be lost.

It is interferometry that is being used to convert the phase distribution into an irradiance pattern stable in time and space which can be recorded in a photographic film or detector. This is the basis of Gabor's invention of holography (Gabor, 1949). He proposed to add a coherent reference wave to the object wave and produce an interference pattern stable enough to be recorded on a photosensitive medium. When the medium is developed and illuminated appropriately then it diffracts light in a manner such as that the complex amplitude U_o is reproduced

* Corresponding author

at the plane of the medium. All this was accomplished using the simple system shown in figure 1.

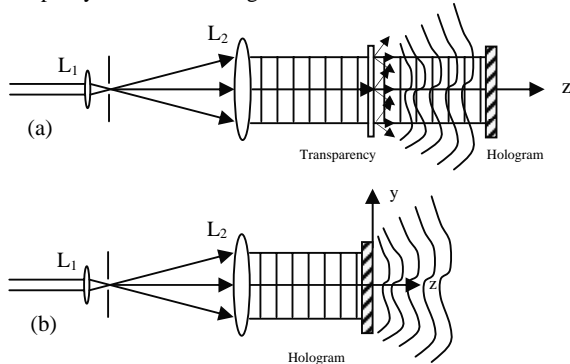

Figure 1: Gabor's on-axis optical configuration to a) record a wave field and b) reconstruct it without need of the actual object. (L_1 , L_2 Lenses)

As it is seen in figure 1 one beam is transmitted through the transparency and part of the beam is diffracted from it. Interference follows among the diffracted and the undiffracted part of the beam. The intensity values governing the interference pattern are recorded on recording plane or hologram plane by means of a photosensitive medium. If the medium that holds the intensity distribution and is now termed diffraction grating or hologram is illuminated by the original beam the initial record is reconstructed in absence of it.

Many optical geometries have followed the on-axis arrangement aiming to generation of new applications in a variety of fields and introducing a powerful optical instrument in engineering and science. However all optical systems developed are based on the fundamental phenomena of interference and diffraction as shown in the original Gabor's principle.

2.1 Experiment- Set up

The laser used is a CW diode pumped, Nd-YAG, emitting at 532 nm a highly coherent TEM₀₀ beam, mounted on an optical table. The beam is guided by mirrors to a spatial filter with an objective lens 20x in order to uniformly diverge it. The laser beam is illuminating the object in a 45° angle as shown in figure 2.

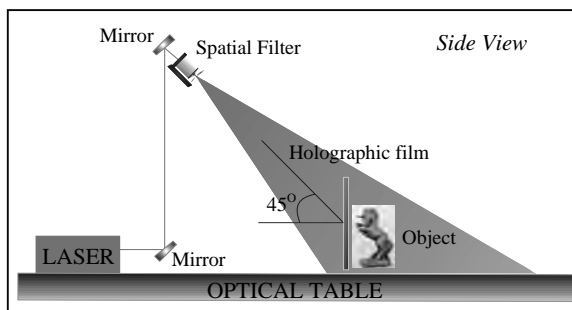

Figure 2: Side view of a single beam set up for the recording of a reflection hologram

The holographic film is placed between the beam and the object (very close to the object) and it is exposed once for 1sec, under safe light and then follows the chemical developing.

The films used to record the reflection holograms were the BB plates, green sensitive silver halide emulsion on glass and the chemical processing is the one given by the company on their website (<http://www.colourholographic.com>).

3. RESULTS

A number of characteristic importance museum copies have been used to generate a first database of three dimensional representations for educational and communicational purposes.

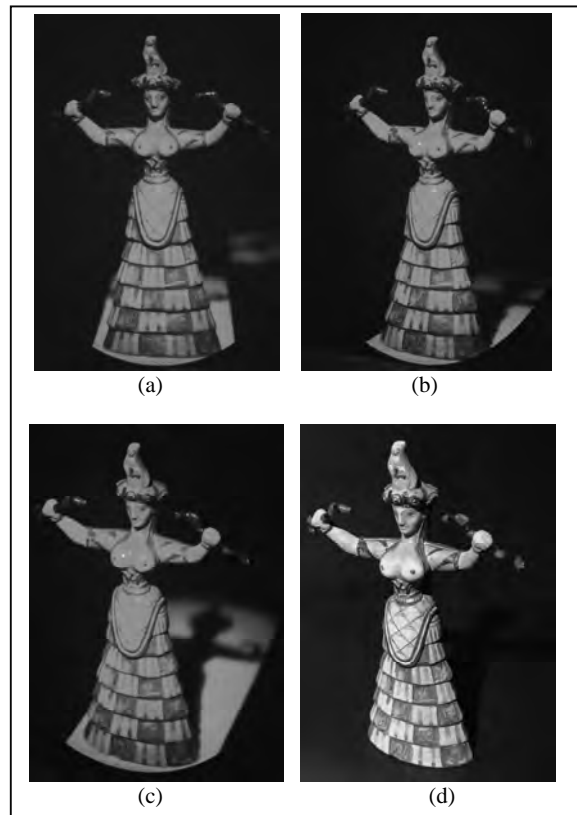

Figure 3: Photos of a reflection hologram of a "Snake Goddess" copy, recorded by a cw green laser (at 532nm). (a) Front view, (b) side view, (c) top side view of the same hologram and (d) photograph of the copy illuminated with white light.

The database consists of archaeological subjects with different geographical distribution across Greece, such as Macedonia, Cyclades and Crete. Objects with strong three dimensional character (snake goddess) have been mostly used in order to highlight the effectiveness of the three -dimensional representation as well as two dimensional objects (phaistos disc) incorporating fine surface details, thus requiring high spatial resolution. In this way these examples can reconstruct in high fidelity both depth and surface information.

The Snake Goddess describes a number of figurines of a woman holding a serpent in each hand found during excavation of Minoan archaeological sites in Crete dating from approximately 1600 BCE. By implication, the term 'goddess' also describes the deity depicted; although little more is known about her identity apart from that gained from the figurines. The 'Snake Goddess' figure first discovered was found by the British archaeologist Arthur Evans in 1903. The figurine found by

Arthur Evans uses the faience technique, for glazing earthenware and other ceramic vessels by using a quartz paste. After firing this produces bright colors and a lustrous sheen. While the idol's true function is somewhat unclear, her exposed and amplified breasts suggest that she is some sort of fertility figure. The serpent is often associated with the renewal of life because it sheds its skin periodically. Throughout history, snakes have also been associated with male fertility. The figurine is today exhibited at the Herakleion Archeological Museum in Crete (Powel, 1998).

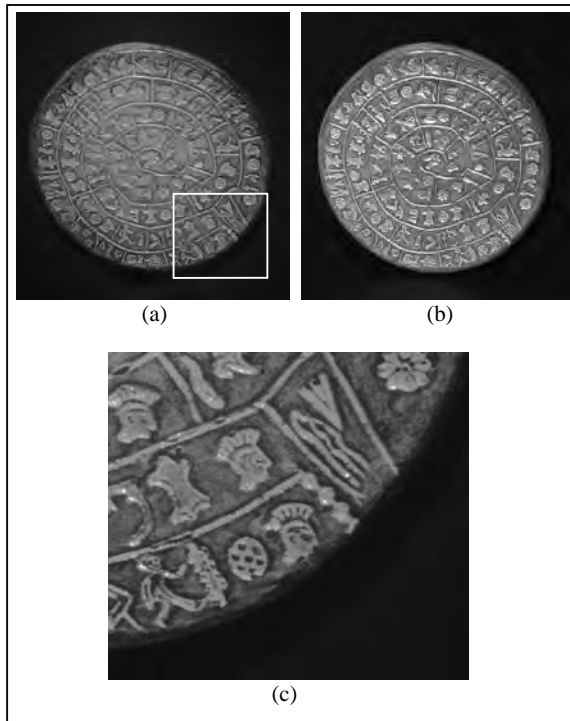

Figure 4: Photos of a reflection hologram of a "Phaistos Disc" copy, recorded by a cw green laser (at 532nm). (a) Front view, and (c) detail of the same hologram, marked with red in (a). (b) Photograph of the copy under white light.

The Phaistos Disc is a disk of fired clay from the Minoan palace of Phaistos, likely dating to the middle or late Minoan Bronze Age (2nd millennium BC). It is covered on both sides with a spiral of stamped symbols. Its purpose and meaning, and even its original geographical place of manufacture, remain disputed, making it one of the most famous mysteries of archaeology. The Phaistos Disc was discovered in the Minoan palace-site of Phaistos, near Hagia Triada, on the south coast of Crete; specifically the disc was found in the basement of room 8 in building 101 of a group of buildings to the northeast of the main palace. This grouping of 4 rooms also served as a formal entry into the palace complex. Italian archaeologist Luigi Pernier recovered this remarkably intact "dish", about 15 cm in diameter and uniformly slightly more than one centimetre in thickness, on July 3, 1908 during his excavation of the first Minoan palace. This unique object is now on display at the archaeological museum of Herakleion in Crete, Greece (Balistier, 2000).

4. CONCLUSIONS

Holography provides a three dimensional display which can be used to generate optical replicas from museum objects. The holograms are three dimensional representations which can be used for educational, communication, archiving, collection and display purposes from people around the globe. A database of holograms from museum objects is on progress.

5. REFERENCES

- Kock, W., E., 1975. *Engineering applications of lasers and holography*; Plenum Press, New York, USA,.
- Saxby, G., 1994. *Practical Holography*. 2 ed., Hemdt Hempstead (UK): Prentice-Hall International.
- Fotakis, C.; Anglos, D.; Zafropoulos, V.; Georgiou, S.; Tornari, V., 2006. *Lasers in the Preservation of Cultural Heritage; Principles and applications*; Editors. R. G. W. Brown, E. R. Pike; Taylor and Francis, New York
- Gabor, D., 1949. *Microscopy by reconstructed wavefronts*. Proc. Roy. Soc., **A197**, p. 454-487
- Powell, Barry B., 1998. *Classical Myth. With new translations of ancient texts by Herbert M. Howe*. Upper Saddle River, New Jersey: Prentice-Hall.
- Balistier, T., 2000. *The Phaistos Disc - an account of its unsolved mystery*. Verlag Thomas Balistier.

6. ACKNOWLEDGEMENTS

From this position authors wish to acknowledge Benaki Museum of Athens, Cycladic Museum of Athens for supporting the concept of holography replicas of Museum objects and sharing advices and original copies. The work is performed in the holography laboratory of Institute of Electronic Structure and Laser in the Foundation for Research and Technology in Crete, Greece.

A VISUALIZATION TOOL FOR CROSS-LINKING MULTIPLE CLASSIFICATION HIERARCHIES FOR HISTORIC COSTUME

Kathi Martin

Associate Professor, Department of Fashion and Design & Merchandising, Westphal College, Drexel University, 33rd & Market Streets, Philadelphia, PA 19104

KEY WORDS: Multiple Thesaurus, Controlled Vocabulary, Historic Costume, Classification

ABSTRACT:

This paper reports on a project to design a tool to cross link terms from one hierarchy of terms for historic costume to another, easily implemented and visualized. The parent project is a standards compliant, best practices, undertaking to preserve and freely create access, via digital surrogate, to the world class holdings of a historic costume collection. The image standards of the Museum Online Archive California and the data standards of the Open Archive Initiative have been incorporated into the data structure. The website features QTVR panoramas of selected garments, rich details of embellishment and construction and, unique among online costume collections, a moving runway where viewers may create custom “fashion shows” from multiple search criteria, including costume category. Analysis of user requirements revealed the need to aggregate the variety of terms for describing categories of historic costume. A top-down feature hierarchy of terms, topped by the vocabulary of terms of the International Council of Museums and drilling down to terms for fashion, where the entire cascade of terms is displayed, was created which proved sufficient for most American and European collections but was not globally inclusive. For example, by merely adding a branch of ethnographic terms from another classification structure, a term could inherit features that differed from the parent hierarchy and create a visually cumbersome structure. The tool was created to show the relationship of terms across multiple hierarchies, visually comprehensible.

1. INTRODUCTION

1.1 Background

“Material culture is the conventional name for the tangible yield of human conduct. We have things to study, and we must record them dutifully and examine them lovingly if the abstraction called culture is to be compassed. Art (and design) embodies and insistently exhibits personal and collective identities, aesthetic and instrumental purposes.” (Glassie, 1999) Historic costume can illustrate social phenomenon. The holdings of the Drexel Historic Costume Collection, which are conserved and made accessible by this project, exemplify the material culture of the upper classes from the Fin de Siècle and the Gilded Age through the many high end designer fashion trends of the twentieth century. They offer an opportunity for sociologists, anthropologists, historians and designers to study the rise of the power elite through an examination of one of the ways in which they spent and displayed their wealth and how designers interpret social phenomena through their design process and realization.

Displaying digital surrogates of these artefacts on the World Wide Web brings this material culture to a wide and diverse audience. The rich detail of construction and embellishment, 3-D panoramas via Quick Time VR, archival information and multiple ways to search the Collection bring the viewer into the culture, whether it is theirs and familiar, or whether it is foreign terrain. The ability to produce custom fashion shows on the movable runway by choosing from drop lists of decade, designer, category, fabric, and donor, further involves the viewer by allowing them to construct the content. <http://digimuse.cis.drexel.edu>

1.2 Controlled Vocabulary

Controlled vocabulary is an established list of standardized

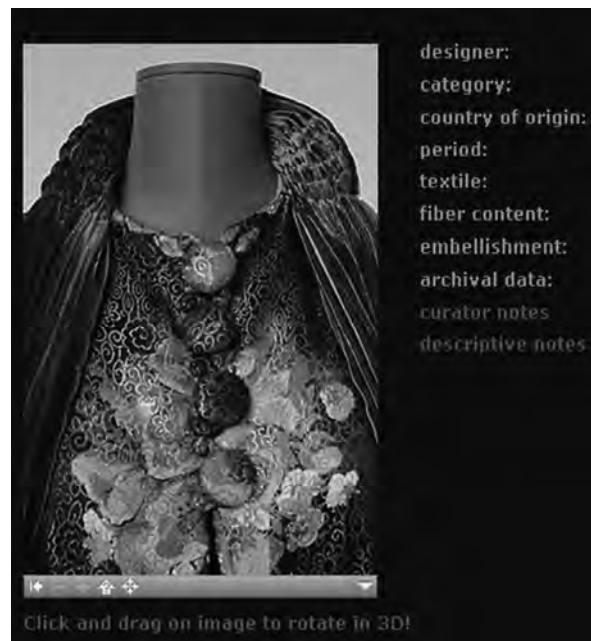

Figure 1: Detail, online Historic Costume Collection

terminology for use in indexing and retrieval of information. Using a standardized terminology, collaboratively developed, allows viewers from various institutes and disciplines to search the database effectively and expediently. Grouping related terms in an online thesaurus hierarchy helps define an object through its placement in the thesaurus hierarchy. The grouping also makes it easier to find the correct term by providing broader or narrower terms related to a topic. These terms can also be integrated into a object’s metadata so that it may be

more easily retrieved in a database search. The Open Archive Initiative is creating new standards and strategies for sharing information between database interactive websites. By creating OAI-PMH compatible metadata records which include this vocabulary, our resource is opened to OAI service providers, potentially reaching more audiences through those providers.

Key to producing the custom fashion show is providing the viewer with appropriate terminology to search the database. On the search screen of the website the “decade”, “designer” and “donor” fields are explicit. Holdings were designed by one designer, in one decade and donated by one individual or institution. Costume category and fabric are more complex. Fabric can be described by both fibre content and construction. Various hierarchical thesauri exist for fabric construction. At this time, on our website, very basic terms for category and fabric are provided in drop lists from which the viewer may choose. The terms reflect the type of holdings in the Collection and those which have been digitized for the online Collection. They were determined by interview of students and faculty; for category, daywear (suit, dress, jumpsuit), eveningwear (evening gown, cocktail dress), Chinese robe; and for fabric, silk, velvet, wool, lace satin, cotton. This approach of choosing category terms from a pick list of fashion terms is used by projects such as the data entry form designed by Lei Zeng, Kent State University which utilizes terms from Picken’s Dictionary of Fashion. (Zheng, 1999)

1.3 Thesaurus

Thesauri describe an object by arranging it in a hierarchy of like and related objects and allowing other declarations to be made about the objects. In their guidelines for the establishment and development of monolingual thesauri, the International Standard of Organization provides the properties for describing objects such as “broader term”, “top term”, “synonym”, and “related term.” Additionally, there is a provision, “scope note”, to append a string to the field which in which an exact definition can be displayed. (ISO, 1999) These properties enrich the object’s description and expand the possibilities for data entry and retrieval. “Related term” can create an association with another hierarchy.

Our online drop list terms are temporary. The focus of the project is now to work on inclusive classification hierarchies for costume category and fabric, beginning with category. Work to date on the hierarchy has been implemented into the data entry form and will be linked to the website in the future. Our objectives are to provide terminology familiar to our users to aid in their search; include established thesauri; and incorporate the terminology into our metadata structure to support efficient and precise online search and retrieval. As determined early in the project by survey and interview, our user groups include historic costume scholars, fashion design students and faculty, and fashion designers. To serve this varied audience, we want to marry historic costume terminology with contemporary fashion design terminology.

The ICOM International Committee of Museums and Collections of Historic Costume has been working for several years on building a hierarchical vocabulary of basic terms for cataloguing historic costume. (ICOM, 1999) This vocabulary identifies a garment by its position on the body and, somewhat, by its construction. This frees the term from language determined by nationality and fashion trend, i.e. tube top, an American term for a bodice that is merely a band of fabric

around the torso, in French is bandeau. In the ICOM vocabulary it becomes: women’s garments>main garments>covering the body above the waist>bodice. This entry is illustrated by a t-shirt and there the description ends. There is no continued, full description of the tube top being sleeveless or strapless. A search on bandeau in the online Getty Thesaurus of Art & Architecture retrieves a definition of headband or sweatband.

We set about to take the hierarchy deeper by adding fashion terms from Pickens Dictionary of Fashion as well as borrowing extensively from the Getty Art and Architecture Thesaurus where we could. The terminology was further extended by fashion terms commonly used by Fashion Design faculty in the College in their courses and terms which have appeared in at least three fashion periodicals. There are plans to incorporate the ISO 2788 properties to the thesaurus. Because of limited resources, our project relies heavily on independent study and graduate students to aid in the data entry. To enable ease of data entry from a variety of domain expertise and data entry skills we provide the thesaurus via a link from the category field on the data entry form. The cataloguer can work down through the thesaurus, starting with the ICOM terms and ending with the fashion term. When the record is retrieved, the entire cascade of terms is displayed for costume category.

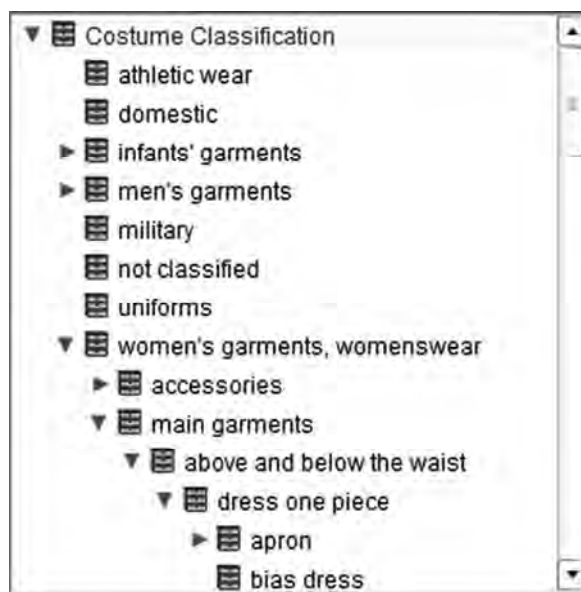

Figure 2: Thesaurus

1.4 Metadata

Owing to the flexibility and complex structure of natural language, which allows for the representation of a concept in various ways, there is a critical need for addressing the need for a common understanding of metadata elements. Descriptive metadata elements describe the intellectual content and association of resources in a way that facilitates search, identification and collocation of information contained within or exemplified by the resource. This is especially evinced through information-sharing for non-networked traditional bibliographic collections through authority control. Successful resource discovery across ever-growing distributed digital collections demands semantic interoperability across vocabulary schemes (e.g., classification, thesauri) and accurate and consistent metadata creation and mapping (Park, 2006)

Metadata standards for this project have been drawn from multiple schemes such as VRA (Visual Resource Association), CDWA (Categories for the Description of Works of Art), locally created metadata elements specifically geared toward historic costume, OAI (Open Archive Initiative) and Dublin Core (DC). Thus, metadata elements drawn from multiple standards and locally created metadata elements are mapped onto DC elements. An enhanced classification and categorization scheme will also be integrated into the user interface in order to facilitate browsing the collection

1.5 Faceted Classification

Faceted classification divides each term into facets which can be assigned descriptive terms: personality (primary subject of object), matter (material from which the object was made), energy (processes used in creation of the object), space (location of the object) and time (when the object was made). This allows the object to be described from a variety of perspectives. Each facet can be thought of as an axis along which an object can be described. (Garshol, 2008) Adding facets to our thesaurus could increase the access points to our online database. A beaded silk chiffon evening gown from 1912 by the French designers Callot Soeurs, donated by the estate of Minnie Cassatt, could be retrieved, through the “matter” and “energy” facets, by a search on beading techniques; from “space” and “time” by a search on industry in France in the 1910’s. Exchangeable Faceted Metadata Language (XFML) is designed to enable controlled vocabulary creators to publish and share metadata systems.

2. THE TOOL

2.1 Collaborators

In a review of the project, a world renowned textile designer, author and scholar, remarked on how, because of the superb quality of the textile details illustrated on the website, the project would be of great value as a tool for textile research. In 1998, with funding from the Henry Luce Foundation, the reviewer and an advisory committee composed of distinguished museum and design professionals developed “Objects Classified by Medium” (OCBM) in response to the concern that existing systems do not provide the tools for comparing information on objects. The OCBM classification system seeks to organize areas of study in fiber, clay, metal, and wood to allow curators and scholars to compare information on similar methods used; build a conceptual framework for the greater understanding of whole categories of objects, rather than as isolated works; and provide a finding tool for cross-cultural and cross-disciplinary investigation. We share the OCBM vision that a “common understanding and definitions of terms are crucial to the success of a classification project meant to cross institutional and national boundaries”. (Larsen, 1998) Although detailed textile classification systems exist for industrial use, such as that of *The World Textiles Thesaurus* which “provides a unique hierarchical overview of all key concepts that are relevant to navigating scientific literature in the textile and fibre domain” there is not an online, freely accessible, easy to navigate system for the educator, student, collector, scholar and designer.

Another colleague, working in New Delhi on a classification for Indian garments, shared the portion on saree (sari) with us. This classification describes the saree, of which there are more than

seventy types included, first by woven construction or embellishment and then by the region from which the saree

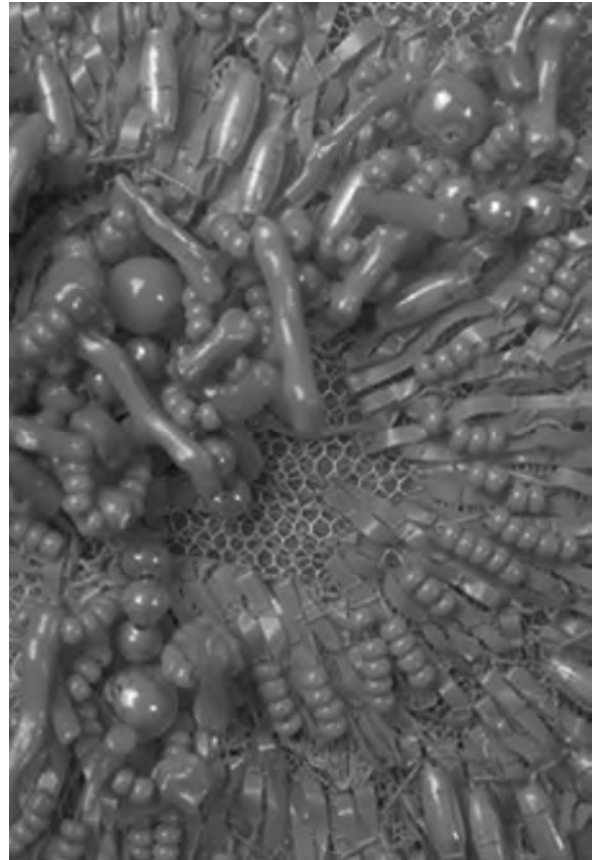

Figure 3: Beading detail, evening gown by Givenchy, c.1970, online Collection

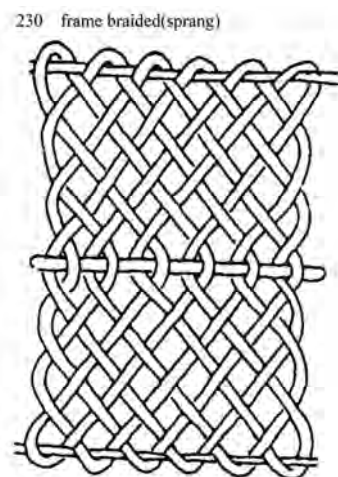

Figure 4: Sample illustration, OCBM

originated. In our thesaurus there is one entry, at the lowest level of the hierarchy, for sari. Incorporating this classification system into our thesaurus raised some very interesting problems as the hierarchy reflects neither ours nor the OCBM. However, if we could aggregate all three systems, illustrated with textile details from the images on our website as well as the line

renderings of textile structure included the OCBM, it could serve to define and illustrate textiles to a broad audience of scholars, collectors, designers and students of textiles and fibre arts.

2.2 Requirements

The design posed many questions. How to link to the Indian classification and then to the OCBM system for this category and others that would present similar problems? Could there be a way to display the system that would reveal high level and low level relationships? Could the display aid in finding problems with the data? Is it even necessary to have an image of the connectedness in order to use the hierarchy?

We looked at the Think Map Visual Thesaurus, an interactive thesaurus which appears to be a good tool for students to learn vocabulary. Words branch to other words with similar meanings. Relationships are shown with a dotted line and lines are colour coded to define them as verb, noun, etc. However, it merely arrays synonyms in a dynamic network map with no hierarchy of parent/child relationship displayed.

The required features of this tool are:

- A captivating and efficacious design
- The ability to easily create links to other thesaurus upon data entry
- The ability to easily create new category nodes upon data entry
- The ability to view the overall system

Students in the Digital Media program in the College had been working on some very interesting interactive online projects so we hired one of the students to work on this challenging project with us. Since most of the objects in the Collection are women's garments we decided to develop that level of the system first.

2.3 Design

Since data entry is done for the most part by students we decided to design a drop and drag tool to facilitate data entry and thesaurus building. The system was to be displayed as a tree with categories and garments represented by nodes. Four types of nodes were designed to fulfil the requirements: garment nodes, created for each garment in the Collection; new category nodes, created for all the nodes in each level of the hierarchy; and direct linker nodes and flat linker nodes to link to other systems. Adobe Flash, Photoshop and Illustrator were used in the design.

The interface and navigation is fairly straightforward. The user opens a design window and a menu consisting of three buttons: "Database", "NodeMap" and "Window". To start a session the user chooses and opens a database, then from "Window" chooses "outliner>new>main categorization". From the Outliner, a click on the arrow next to Main Categorization, cascades all the levels of the hierarchy from the ICOM terms to the lowest level, garments that have been identified by a fashion term.

The user can choose to drag any level of the hierarchy to the design window. Clicking on the "open eye" on the bottom of

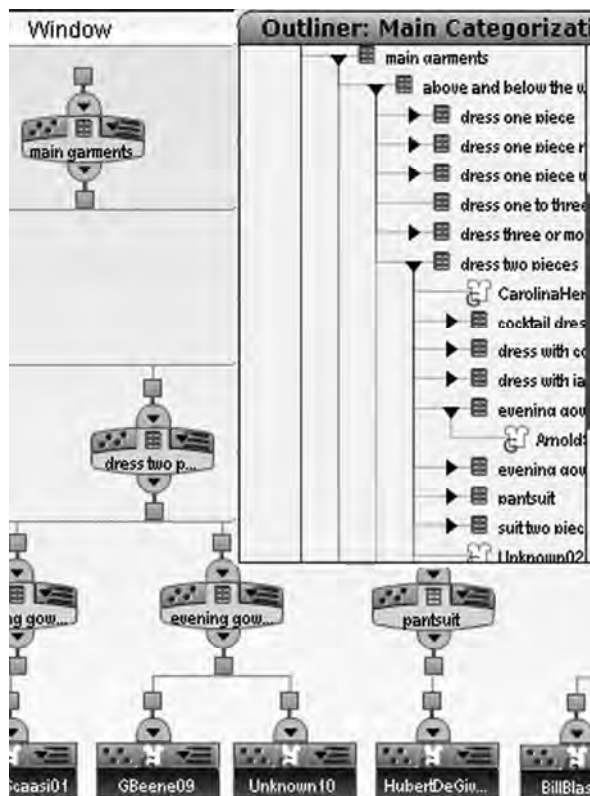

Figure 5: Main Categorization, open

the node opens all the nodes on the next lower level. Clicking on the "closed eye" closes all nodes on all levels below the parent and clicking on the up arrow on the node opens the nodes on the next level up. Clicking on a node displays the name and properties of the node in the "Property Inspector", accessible from "Window". Also in "Window" is the "New Nodes" function. To create a new node, one drags a "new category" node to the design window, names it in the "Property Inspector" and by pulling a red line from the bottom left button on the parent node to its head is linked to the appropriate parent and visa versa. On the bottom right is a break link feature which can be clicked on any parent node to break a link and move a child node and all the levels below it to another position.

"New Direct Linker" and "New Flat Linker" function in the same manner to link one system to another from any level of the hierarchy. From "NodeMap" on the menu, the viewer can zoom in and out on the window.

2.4 Testing

Developing and testing the features and functions of the system were iterative until all the bugs were worked out. The tool was then demonstrated to the graduate assistant who was working on the data entry. With only an hour of training the student was able to use the tool to populate the lowest level of the hierarchy with garment nodes and add, after consultation on appropriate term, new category nodes. All went smoothly until the population at the lowest level of the hierarchy began to grow. It became difficult to see an overview of the entire hierarchy unless zoomed way out which made the node names unreadable.

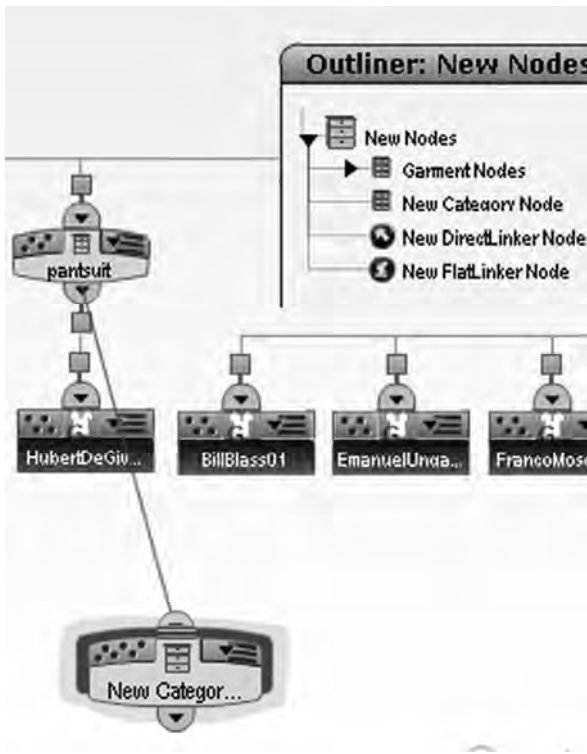

Figure 6: Linking nodes

“Mini-Map” and drag it to the design window to work on it. This worked fine for the student who had been populating the system because, as she did so, she became familiar with the screen location of the various parts of the tree. We have a turnover in student population and plan to engage our collaborators in linking systems with our “easy to use”, captivating tool. It is critical that the overall structure as well as the function of the system be readily comprehensible. At this point in time we are at as standstill as the system does not meet that very important requirement.

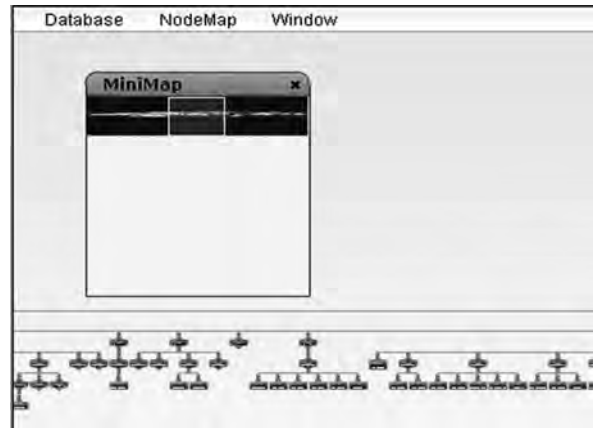

Figure 8: Mini - Map Function

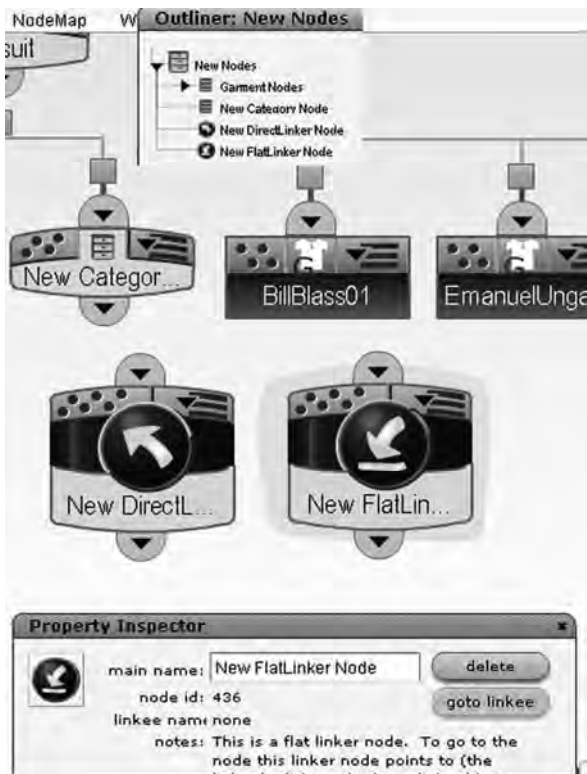

Figure 7: New Nodes Function

3. NEXT STEPS

Our approach to our goal had been to first create the implementation tool and then define the rules and relationships for the terms in the various hierarchies. The International Committee for Museum Documentation (CIDOC) has done much work to develop a common and extensible semantic framework for the implicit and explicit concepts and relationships of cultural heritage information. As we did when we adopted the OAI protocols to our database records and metadata, we plan to use the CIDOC Conceptual Reference Model (CRM) to map our information to the CIDOC semantic structure. We also plan to explore how to incorporate this mapping into our metadata.

4. CONCLUSION

Effectiveness is the measure of technology. System structure benefits from the mega and meta perspectives. Our sleek node design, referred to by the data entry student as the “mother ships”, and easy to use thesaurus building functions, were initially impressive but ultimately useless for building large and linked systems. We failed to add ease of interpretation of the system since the entire structure could only be viewed in the Mini-Map, like a galaxy far, far away.

This approach was a “from the outside in” method of developing a graphic interface for a system’s function without fully understanding the implications of the desired function. By working first with the CIDOC model “from the inside out” we will benefit from lessons learned by other cultural heritage professionals interested in mapping localized information. Whether the tool we developed will ever be useful in visualizing the mapping will remain to be seen.

We returned to design and developed a “Mini-Map” which, when accessed from “Window”, displays the entire system from a bird’s eye view. The user can select any area of the

5. REFERENCES

Garshol, Lars Marius. Metadata? Thesauri? Taxonomies? Topic Maps! Making sense of it all. Oslo, Norway. <http://www.ontopia.net/topicmaps/materials/tm-vs-thesauri.html#N645> (accessed 22 May 2008)

Glassie, Henry, 1999. *Material Culture*. Indiana University Press, p.41.

ICOM International Committee for the Museums and Collections of Costume. Vocabulary of Basic Terms for Cataloguing Costume. Paris, France. <http://www.mda.org.uk/costume/vbt00e.htm> (accessed 10 May 1999)

ISO Technical Committee (TC) 46. "Guidelines for the establishment and development of monolingual thesauri." Ottawa, Canada. <http://www.collectionscanada.gc.ca/iso/tc46sc9/standard/2788e.htm#3> (accessed 1 Dec. 1999)

Larsen, Jack Lenor, et al, 1998. *Objects Classified by Medium*. Longhouse Reserve, Easthampton, NY USA, pp. 2-6.

Park, Jung-ran, 2006. Semantic Interoperability and Metadata Quality: An Analysis of Metadata Item Records of Digital Image Collections. *Knowledge Organization*, 33(1), pp. 20-34.

The International Committee for Museum Documentation <http://cidoc.mediahost.org/> (accessed 15 August 2008)

Zeng, Marcia Lei. Template for Cataloging Historical Fashion Collections at Kent State University, based on VRA Core Metadata. Kent State University, Ohio. <http://circe.slis.kent.edu/mzeng/fashionterm.html> (accessed 10 Dec. 1999)

6. ACKNOWLEDGEMENTS

Thanks to Dr. Sanjay Gupta, Senior Professor and Dean, National Institute of Fashion Technology, NIFT Campus, Hauz Khas, New Delhi, Jack Lenor Larsen, President, Longhouse Reserve, Easthampton, NY. Dr. Xia Lin, iSchool, Drexel University and the many students who have worked on this project over the years.

AUTHOR INDEX

Abdalla, S. S.	93	Hadjimitsis, D. G.	124
Abe, T.	350	Hall, T.	287
Alimi, A. M.	98	Hatziyannakis, K.	374
Arnold, D.	337	Heath, R.	337
Badts, E. De	117	Heldal, I.	43
Baeza, U.	311	Higley, G.	198
Barrera S.,	311	Hirabayashi, M.	356
Battini, C.	220	Hirano, M.	350
Beneš, M.	63	Hong, S.	273
Billen, R.	117	Hradil, D.	63
Bioletti, S.	368	Hradilová, J.	63
Blaise, J. Y.	362	Ioakim, S.	24
Borgherini, M.	167	Ioannides, M.	124
Bråthe, L.	43	Ioannidis, Ch.	24
Bridges, A.	209	Ishida, A.	68
Brown, S.	102	Jabi, W.	287
Buelinckx, E.	84	Jardini, A.	229
Bukin, K. A.	332	Jerem, E.	234
Byington, S. I.	243	Kaimaris, D.	1
Callet, P.	158, 215	Kalay, Y. E.	273
Cancherini, L.	229	Kanaya, I.	122
Cappellini, V.	152	Katsikas, A. A.	269
Carillo, E.	337	Khazraee, E.	281
Carrozzino, M.	326	Khelifi, B.	98
Celani, G.	229	Kiss, F.	253
Charakis, M.	39	Kobayashi, T.	356
Clay, C. R. I.	124	Kounoudes, A.	139
Constantopoulos, P.	164	Laghos, A.	258
Crysostomou, Ch.	24	Lam, S.	273
Dahl, B. O.	298	Lanitis, A.	139, 305
Dallas, C.	164	Laszlovszky, J.	234
Davies, R.	202	Lee, H.-J.	78
De Meyer, R.	18	Ling, J.	146
Degraeve, A.	15	Lupo, E.	193
Del Mastio, A.	152	Malek, H.	281
Diem, M.	188	Marques, e R.	229
Doorn, P.	164	Martin, K.	377
Driscu, T.	362	Martínez Carrillo, A. L.	11
Dudek, I.	362	Maslova, V. A.	332
Dumazet, S.	158, 215	Melaney M.,	347
Finogeeva, A. A.	332	Mitchon, D.	273
Finogeeva, A. G.	332	Mohamed, F.	326
Forghani, H.	281	Moreno Maso, B.	158
Forte, M.	74	Mullot, R.	98
Frangeskides, F.	305	Nagano, N.	356
Garbin, E.	167	Naruto, N.	350
Garcia-Moreno, R.	117	Nassar, S. K.	93
Gavrilis, D.	164	Navas Lara, J. I.	11
Genechten, B. Van.	53	Nicolodi, M.	177
Geogoula, O.	1	Nilsson, D.	264
Georgiadis, Ch.	1	Noel, S. J.	49
Georgopoulos, A.	24	O'Sullivan, C.	368
Gottlieb, C. P.	264	Ogawara, M.	350
Gottlieb, H.	264	Oliveira, M. F.	229
Gros, A.	164	Opstaele, H.	84
Hadjimitsis D. G.,	109	Otaola, A.	311

Ozawa, S.	350	Skoda, S.	229
Papadopoulos, K.	139	Söderström, M.	146
Papantoniou, G.	305	Spagnoli, A.	320
Papatheodorou, T. S.	292	Stahre, B.	43
Patias, P.	1	Stamnas, A.	1
Pauwels, P.	18	Staral, K. M.	49
Pecchioli, L.	326	Steed, A.	43
Perez, Y.	273	Stenborg, P.	146
Piccoli, V.	229	Stocking, M.	133
Pietroni, E.	74	Stylianidis, S.	1
Polydorou, D.	316	Stylianou, G.	164
Pupo, R.	229	Suzuki, H.	68
Rahaman, H.	30	Szabó P.,	234
Raj, D.	183	Takata, Y.	122
Raposo, A.	243	Tanaka, K.	350
Rashid, Md M.	30	Themistocleous, K.	109, 124
Razak, A.	209	Thuvander, L.	146
Redmann, C. P.	225	Tigny, V.	117
Rigby, A. J.	347	Tornari, V.	374
Rigby, K.	347	Tornberg, J.	146
Rodriguez-Echavarria, K.	337	Török, M.	253
Roy, D.	6	Trocchianesi, R.	249
Rubio Paramio M. A.,	11	Tsapatsoulis, N.	139
Ruhland, K.	368	Tsiranidou, E.	374
Ruymbeke, M. van	117	Tsolis, D. K.	292
Sablatnig, R.	188	Uccheddu, F.	152
Santana Quintero, M.	53	Van Campenhout, J.	18
Sanyal, R.	183	Vandarakis, A. G.	49
Sarol, Z.	158	Vasáros, Zs.	234
Sato, K.	122	Végvári, Zs.	234
Schroeder, R.	43	Venetopoulos, Ch. G.	269
Schueremans, L.	53	Verdiani, G.	177
Sedlmair, M.	368	Verstraeten, R.	18
Sevara, C.	146	Zaghden, N.	98
Shieittanis, N.	24	Zainal Abidina, M. I.	209
Shimizu, T.	356	Zitová, B.	63
Silva, J. V. L. da	229	Zymla, A.	158